



Power factor regulator

iPFC max6, iPFC max12



INSTRUCTION MANUAL



SAFETY PRECAUTIONS

Follow the warnings described in this manual with the symbols shown below.



DANGER

Warns of a risk, which could result in personal injury or material damage.



ATTENTION

Indicates that special attention should be paid to a specific point.

If you must handle the unit for its installation, start-up or maintenance, the following should be taken into consideration:



Incorrect handling or installation of the device may result in injury to personnel as well as damage to the device. In particular, handling with voltages applied may result in electric shock, which may cause death or serious injury to personnel. Defective installation or maintenance may also lead to the risk of fire.

Read the manual carefully prior to connecting the device. Follow all installation and maintenance instructions throughout the device's working life. Pay special attention to the installation standards of the National Electrical Code.



Refer to the instruction manual before using the device

In this manual, if the instructions marked with this symbol are not respected or carried out correctly, it can result in injury or damage to the device and /or installations.

iskra reserves the right to modify features or the product manual without prior notification.

DISCLAIMER

Iskra reserves the right to make modifications to the device or the unit specifications set out in this instruction manual without prior notice.

Iskra on its web site, supplies its customers with the latest versions of the device specifications and the most updated manuals.

www.iskra.eu



Iskra recommends using the original cables and accessories that are supplied with the device.

CONTENTS

SAFETY PRECAUTIONS	3
DISCLAIMER	3
CONTENTS.....	4
REVISION LOG	6
SYMBOLS.....	6
1 - VERIFICATION UPON RECEPTION	7
2 - PRODUCT DESCRIPTION	7
3 - INSTALLATION OF THE DEVICE	8
3.1 - PRELIMINARY RECOMMENDATIONS.....	8
3.2 - MECHANICAL INSTALLATION	9
3.3 - ELECTRICAL INSTALLATION.....	9
3.4 - DEVICE TERMINALS	10
3.4.1 - iPFC max6.....	10
3.4.2 - iPFC max12	11
3.5 - CONNECTION DIAGRAM	12
4 - OPERATION	13
4.1 - DEFINITIONS.....	13
4.1.1 - FOUR-QUADRANT REGULATOR.....	13
4.1.2 - STAGES AND STEPS.....	13
4.1.3 - FCP (FAST COMPUTERIZED PROGRAM) SYSTEM	14
4.1.4 - REGULATION PROGRAM.....	14
4.1.5 - PLUG & PLAY	14
4.1.6 CONNECTION TIME (T _{on}) AND RECONNECTION TIME (T _{rec})	15
4.1.7 HARMONICS AND THD	15
4.2 - MEASUREMENT PARAMETERS	15
4.3 - DISPLAY	16
4.4 - KEYBOARD FUNCTIONS	17
4.5 - ALARM RELAY.....	17
5 - DISPLAY.....	18
5.1 - DISPLAY SCREENS.....	18
5.1.1 - MAXIMUM & MINIMUM VALUES.....	20
5.1.2 - ALARMS	20
6 - CONFIGURATION	22
6.1 - PLUG&PLAY.....	24
6.2 - PRIMARY CURRENT	25
6.3 - TARGET COS φ	26
6.4 - No. OF STAGES.....	26
6.5 - PROGRAM	27
6.6 - CONNECTION TIME	28
6.7 - RECONNECTION TIME	28
6.8 - C/K FACTOR.....	29
6.9 - PHASE CONNECTION	31
6.10 - ADVANCED SETUP	32
6.10.1 - STATUS OF THE STAGES.....	32
6.10.2 - COS φ HIGH ALARM	33
6.10.3 - COS φ LOW ALARM	34
6.10.4 - THD VOLTAGE HIGH ALARM.....	35
6.10.5 - THD VOLTAGE LOW ALARM	35
6.10.6 - INDUCTIVE VALUE OF HYSTERESIS	36
6.10.7 - CAPACITIVE VALUE OF HYSTERESIS	36
6.10.8 - ENABLING THE NO CURRENT ALARM (E01).....	37
6.10.9 - ENABLING THE OVERCOMPENSATION ALARM (E02)	37
6.10.10 - ENABLING THE OVERCURRENT ALARM (E03).....	37
6.10.11 - ENABLING THE OVERVOLTAGE ALARM (E04).....	37
6.10.12 - ENABLING THE LOW VOLTAGE ALARM (E05).....	38
6.10.13 - ENABLING THE COS φ LOW ALARM (E07).....	38
6.10.14 - ENABLING THE COS φ HIGH ALARM (E06).....	38
6.10.15 - ENABLING THE THD VOLTAGE HIGH ALARM (E08).....	38
6.10.16 - ENABLING THE THD VOLTAGE LOW ALARM (E09).....	38

6.10.17 - ENABLING THE INTERNAL ERROR ALARM (E10).....	38
7 - TECHNICAL SPECIFICATIONS.....	39
8 - MAINTENANCE AND TECHNICAL SERVICE	41
9 - GUARANTEE	41
ANNEX A - SETUP MENU.....	42





REVISION LOG

Table 1: Revision log.

Date	Revision	Description
03/23	03-23	First Version

SYMBOLS

Table 2: Symbols.

Symbol	Description
	Compliant with the relevant European directive.
	Device covered by European Directive 2012/19/EC. At the end of its useful life, do not discard of the device in a household refuse bin. Follow local regulations on electronic equipment recycling.
	Direct current.
	Alternating current.
	Equipment safety category: Class II

Note: The images of the devices are for illustration purposes only and may differ from the original device.

1 - VERIFICATION UPON RECEPTION

Upon receiving the device, check the following points:

- a) The device meets the specifications described in your order.
- b) The device has not suffered any damage during transport.
- c) Perform an external visual inspection of the device prior to switching it on.
- d) Check that it has been delivered with the following:

- An installation guide



If any problem is noticed upon reception, immediately contact the transport company and/or Iskra's after-sales service.

2 - PRODUCT DESCRIPTION

The **iPFC max** is a device that measures the mains's cosine parameters and controls capacitor connection and disconnection to correct it. The device also measures and displays every other basic parameter of a mains.

Iskra has 2 models, determined by the number of output relays:

- ✓ **iPFC max6**, with 6 output relays
- ✓ **iPFC max12**, with 12 output relays.



The device features:

- **Display** for viewing the parameters.
- **3 keys** to browse through the different screens and program the device.
- **1 alarm relay**.
- **6 output relays** (iPFC max6) or **12 output relays** (iPFC max12).

3 - INSTALLATION OF THE DEVICE

3.1 - PRELIMINARY RECOMMENDATIONS



In order to use the device safely, personnel operating it must follow the safety measures that comply with the standards of the country where it is to be installed; operators must wear the required personal protective equipment (rubber gloves, approved facial protection and flame-resistant clothing) to prevent injuries from electric shock or arcs caused by exposure to current-carrying conductors, and they must heed the various warnings indicated in this instruction manual.

The **iPFC max** must be installed by authorised and qualified personnel.

Cables must always be kept in perfect condition to avoid accidents or injury to personnel or installations.

The manufacturer of the device is not responsible for any damage resulting from failure by the user or installer to heed the warnings and/or recommendations set out in this manual, nor for damage resulting from the use of non-original products or accessories or those made by other manufacturers.



Contact the after-sales service if you detect that the device is not working properly.



The **iPFC max** regulators are connected to devices containing capacitors, which hold a charge even after the voltage is removed. To avoid the risk of electrical shock, **a minimum of 5 minutes** is required between the time the device is disconnected and when the internal components of the device can be serviced.
Any servicing or use of the device in a manner other than that specified by the manufacturer may compromise the user's safety.

Before connecting the device, make sure **the ground connections** are properly made. Grounding the device incorrectly can cause malfunction and carries a danger of electric shock for the user or anyone working with it.

The necessary precautions must be taken during maintenance work to avoid electric shock and electrocution. Before doing any maintenance, the device should be disconnected and sufficient time should be allowed to pass for the capacitors to fully discharge.

If power factor correction devices are connected in the absence of a load, resonance can occur. This can amplify voltage harmonics, which can damage the correction devices and other equipment connected to the network.

The start-up and shut-down procedures contained in the manual must be followed to avoid damaging any connected devices.

Components or parts of the device must only be adjusted or replaced using original spare parts and following the procedures in the corresponding instruction manual.

3.2 - MECHANICAL INSTALLATION

The device must be installed in a panel ($138 \pm 0.2 \times 138 \pm 0.2$ mm panel hole as per IEC 61554). The thickness of the panel must be ≥ 1.20 mm.

3.3 - ELECTRICAL INSTALLATION



When the device is on, its terminals, opening covers or removing elements may expose the user to parts that are hazardous to touch. Do not use the device until it is fully installed.

All the connection terminals must be inside the electrical panel.

In order to measure the current, an external current transformer (CT) must be installed. Normally the transformation ratio of this CT is $I_n/5$ A, where I_n must be at least 1.5 times higher than the maximum total load current.

The current transformer (CT) must be installed at a connection point through which flows the entire load current that is to be corrected, plus the current of the capacitors themselves (see **Figure 1**)

The CT should preferably be installed in phase L1, while the voltage taps must be connected to phases L2 and L3 (see **Figure 4**).

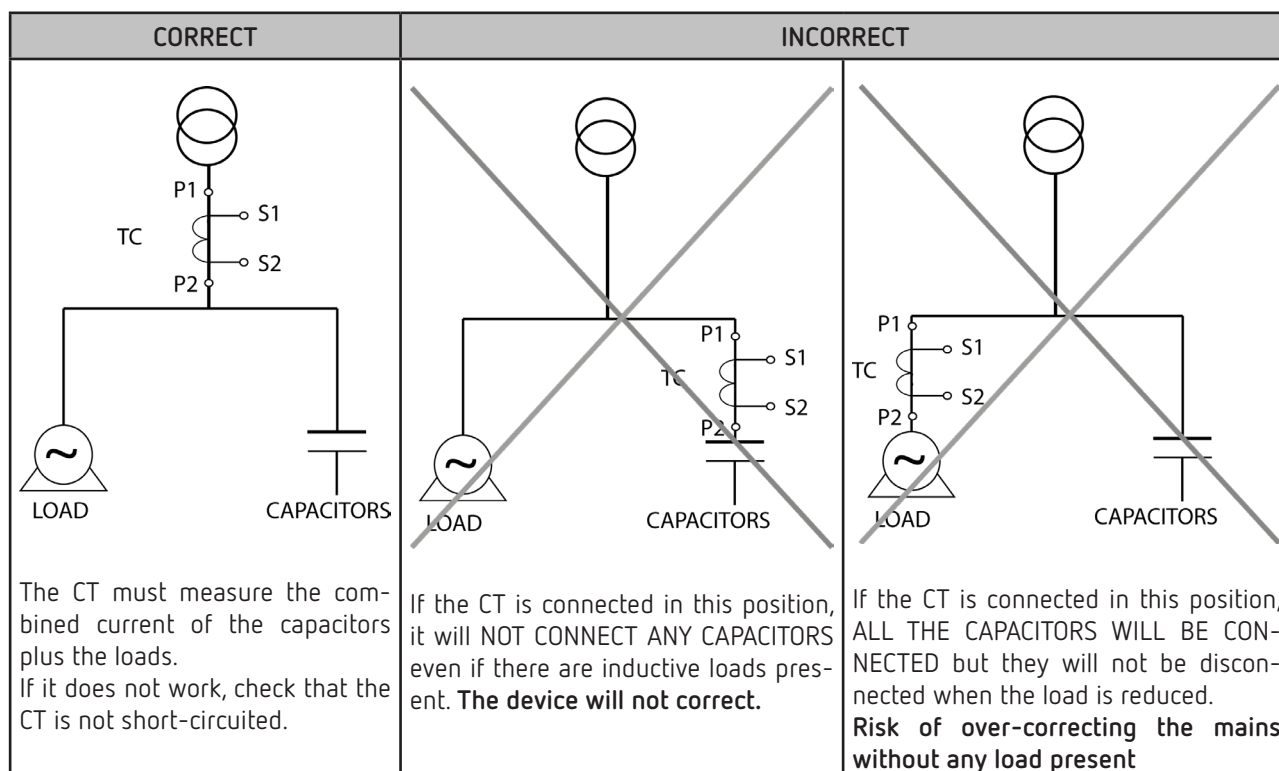

Figure 1: Location of current transformer

Note: The current transformer must be installed in a way that maintains the installation category.

The power circuit must be protected with gL (IEC 60269) or M-type fuses rated from 0.5 to 2A.

A circuit breaker or equivalent device must be installed so that all of the device's control circuits (power supply of the **iPFC max** plus relay circuits and contactor coils) can be connected to and disconnected from the power mains. The switch must be installed on the device itself and be easily accessible.

The power supply and voltage measurement circuits, as well as the relay contact circuits, must be connected with a cable with a minimum cross section of 1.5 mm². The cables on the secondary side of the CT must have a minimum cross section of 1.5 mm². For distances between the CT and the device of more than 25 m, this cross section must be increased at the rate of 1 mm² per 10 m.

3.4 - DEVICE TERMINALS

3.4.1 - iPFC max6

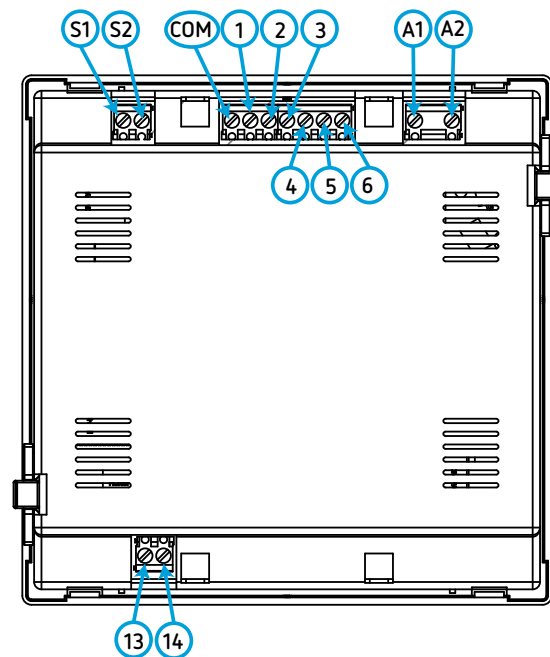

Figure 2: iPFC max6 terminals

Table 3: List of terminals of the iPFC max6.

Device terminals	
A1: ~, Power Supply	3: Relay output 3
A2: ~, Power Supply	4: Relay output 4
S1: Current input	5: Relay output 5
S2: Current input	6: Relay output 6
COM: Common to relays 1... 6	13: Alarm relay (Common)
1: Relay output 1	14: Alarm relay (NO)
2: Relay output 2	

3.4.2 - iPFC max12

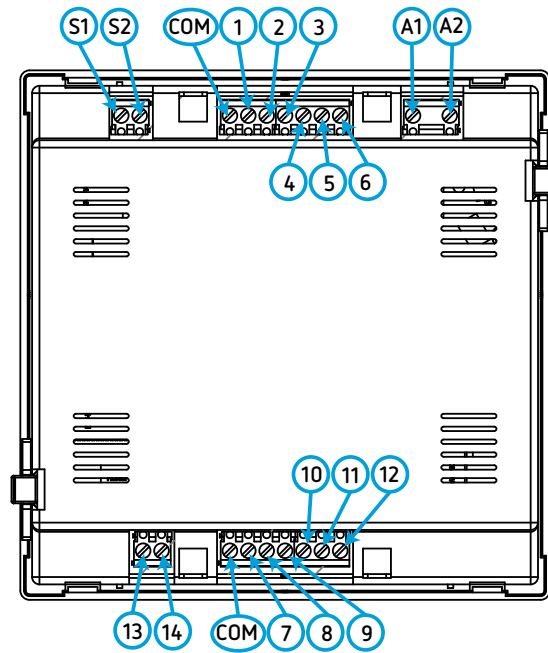

Figure 3: iPFC max12 terminals

Table 4: List of terminals of the iPFC max12.

Device terminals	
A1: ~, Power Supply	6: Relay output 6
A2: ~, Power Supply	7: Relay output 7
S1: Current input	8: Relay output 8
S2: Current input	9: Relay output 9
COM: Common to relays 1... 12	10: Relay output 10
1: Relay output 1	11: Relay output 11
2: Relay output 2	12: Relay output 12
3: Relay output 3	13: Alarm relay (Common)
4: Relay output 4	14: Alarm relay (NO)
5: Relay output 5	

3.5 - CONNECTION DIAGRAM

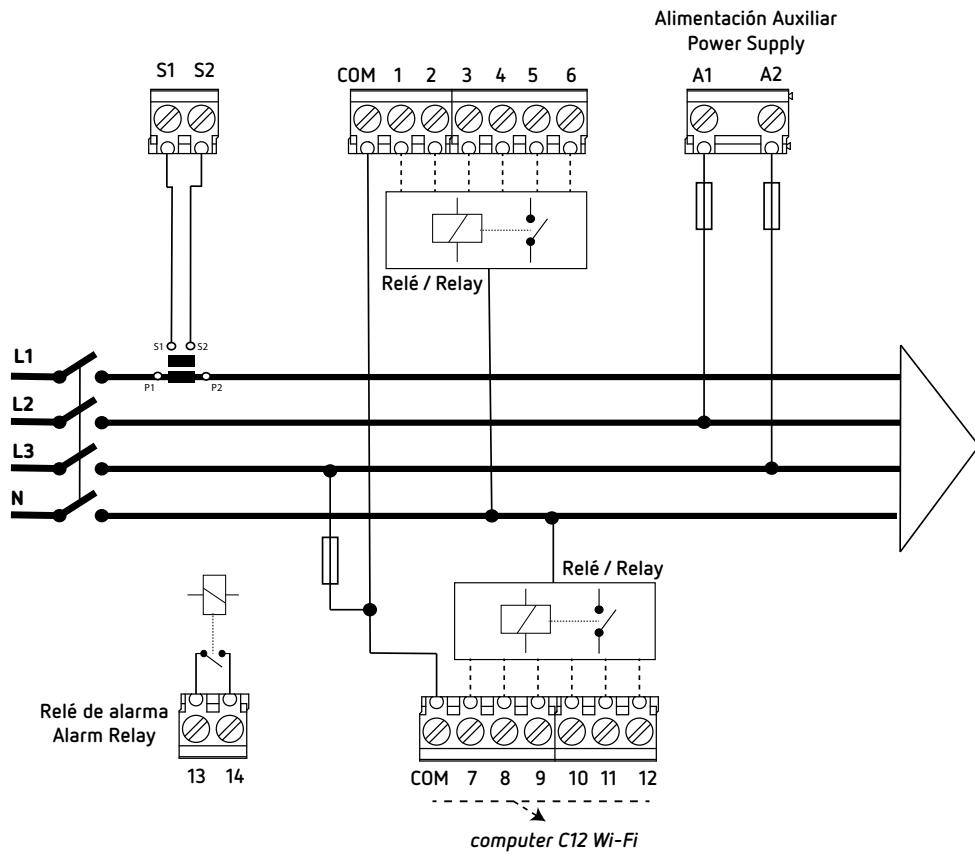

Figure 4: iPFC max connection diagram.

Note: P1, P2, S1 and S2 must be connected as shown in the diagrams. If these connections are not made as shown, the phase must be adjusted as per the procedure in Section "6.9 - PHASE CONNECTION".

4 - OPERATION

The **iPFC max** is a power factor regulator that measures the mains's cosine and connects and disconnects capacitors as needed to correct it.

The device also measures and displays every other basic parameter of a mains (see **Table 5**).

The most important features of this series of regulators include the following:

- **FCP system** that minimizes the number of capacitor connections and disconnections.
- A wide variety of **programs** 1:1:1, 1:2:2, 1:2:4, 1:1:2:2, etc. This allows the total power to be divided up to 31 steps in the **iPFC max6** and 79 steps in the **iPFC max12**.
- **Control in four quadrants** (see **Figure 5**), with indication of the stages connected, $\cos \varphi$, power sign and sign of the reactive power (inductive or capacitive).

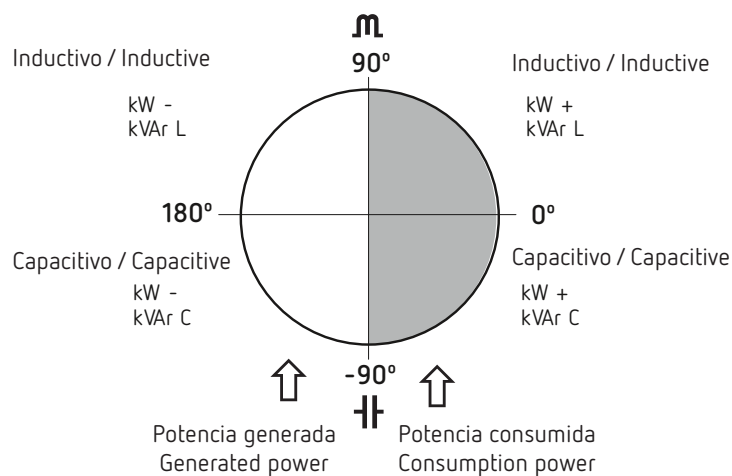

Figure 5: Signs in the measurements of the 4 quadrants.

4.1 - DEFINITIONS

This section defines some concepts that are useful for understanding the operation of the device.

4.1.1 - FOUR-QUADRANT REGULATOR

This term means that the **iPFC max** is capable of measuring and regulating, whether the active power is going from the mains to the load (usual case for a consumer installation) or from the load to the mains (in the case of installations that include generators, and thus allow both the consumption and the export or sale of energy).

4.1.2 - STAGES AND STEPS

We must distinguish between the terms stage and step. In this manual, **stage** is used to refer to each group of capacitors into which a reactive power device is divided. These stages can have different powers, normally in ratios of 1:1, 1:2, 1:2:4, etc.

Step refers to each of the fractions of total power that can be adjusted using stages of different sizes.

4.1.3 - FCP (FAST COMPUTERIZED PROGRAM) SYSTEM

System that controls the connection sequence of the different stages such that, in order to reach a certain demanded final power, it tends to minimise the number of operations and balance out how long the various stages are used. The operations are carried out in such a way that for stages of equal power, when there is a demand, the one that has been disconnected for the longest time is connected, and when there is excess, the one that has been connected for the longest time is disconnected.

4.1.4 - REGULATION PROGRAM

The powers of the different groups or stages usually follow certain patterns called "**programs**". The program specifies the ratio between the powers of the different stages. The most frequent programs are:

Program 1:1:1. All the stages have the same power. *For example, a device with 100 kvar and 5 steps would consist of 5 equal stages of 20 kvar and would be described as a (5 x 20) kvar device.*

Program 1:2:2. All the stages after the first one have twice the power of the first. *For example, a device with 180 kvar and 5 stages would consist of an initial stage of 20 kvar and 4 stages of 40 kvar each, and would be described as a (20 + 4 x 40) kvar device.*

Program 1:2:4. The power of the second stage is double that of the first, and the remaining stages after the second have 4 times the power of the first. *For example, a device with 300 kvar and 5 stages would consist of an initial stage of 20 kvar, a second one of 40 kvar, and 3 equal stages of 80 kvar, and would be described as a (20 + 40 + 3 x 80) kvar device.*

Other Programs. Other programs, such as 1:2:2:4, 1:1:2:2, etc., can be used. The meaning of the numbers, as deduced from the previous cases, gives the ratio of the powers between the first stage, which is assigned a value of 1, and the subsequent stages (2 means double the power, 4 means 4 times more, etc.).

4.1.5 - PLUG & PLAY

When a power factor regulator is installed, a series of parameters must be configured to ensure it works correctly. Some of these parameters may be difficult to determine, such as the voltage phases or the correspondence between the measured current and the voltage, as well as the current transformer ratio.

The **iPFC max** incorporates an automatic process to intelligently find the necessary parameters, such as:

- ✓ **C/K:** Calculates the ratio between the current transformer and the power of the smallest step.
- ✓ **Phase:** Identifies the sequence of phases between voltages and the correspondence with the connected current.

4.1.6 CONNECTION TIME (Ton) AND RECONNECTION TIME (Trec)

The **Connection Time, Ton**, defines the minimum time that must elapse between changes in the status of the stages, i.e., between connections and disconnections. Therefore, this parameter setting directly affects the compensation speed, meaning the ability to monitor changes in the load. If the load can change quickly, setting a small connection time will improve the power factor correction.

However, a small **Ton** will cause a greater number of connections per unit of time, which can shorten the life of the associated components (contactors, capacitors). To evaluate the number of connections, the **iPFC max** has individual counters for each stage.

The **reconnection time, Trec**, is the minimum time between disconnecting and reconnecting the same stage. This time is needed to ensure that the capacitor is sufficiently discharged so that when it is re-connected, it does not cause overvoltages in the system.

4.1.7 HARMONICS AND THD

Non-linear loads such as rectifiers, inverters, variable-speed drives, kilns, etc., absorb non-sinusoidal periodic currents from the grid. These currents consist of a fundamental component with a frequency of 50 or 60 Hz, plus a series of superimposed currents of multiples of the fundamental frequency, which we call harmonics. The result is a deformation of the current, and thus the voltage, which entails a series of associated side effects (overload of conductors, machines and automatic switches, phase imbalance, interference in electronic devices, circuit breaker trips, etc.).

The level of harmonics is normally defined using the total harmonic distortion (THD), which is the ratio, normally a %, between the effective value of the residual harmonic and the value of the fundamental component:

4.2 - MEASUREMENT PARAMETERS

The device displays the following measurement parameters, **Table 5**.

Table 5: Measurement parameters of the iPFC max.

Parameter	Units	Phase	Maximum Value	Minimum Value
Cos φ	φ	✓	-	-
Voltage	V	✓	✓	✓
Current	A	✓	✓	✓
Frequency	Hz	✓	✓	✓
Active Power	kW	✓	✓	✓
Apparent Power	kVA	✓	✓	✓
Reactive Power	kvar	✓	✓	✓
THD% Voltage	% THD V	✓	✓	✓
THD % Current	% THD A	✓	✓	✓
No of operations	-	✓	-	-
No of hours of operation	-	✓	-	-

4.3 - DISPLAY

The device has a backlit LCD display that is split into three areas (Figure 6):

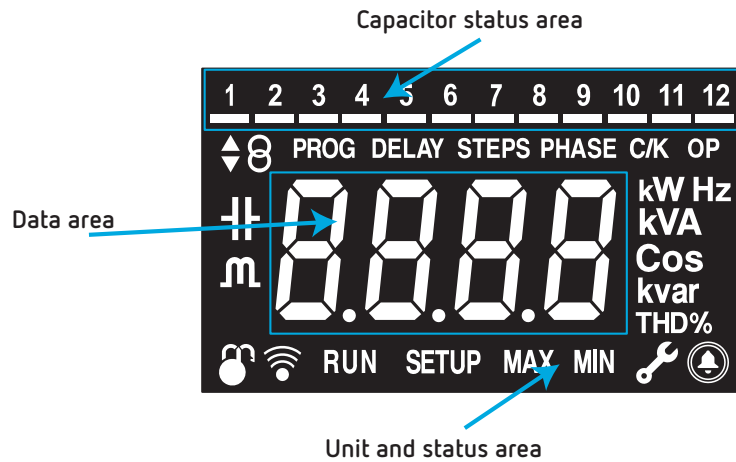

Figure 6: Areas of the iPFC max display.

- ✓ The **data area**, which displays all the values measured by the device.
- ✓ The **unit and device status area**, which displays the different statuses, units and device information (Table 6).

Table 6: Display icons.

Icon	Description	Icon	Description
m	Reactive power > 0, stages connection		Over 9,000 hours of operation.
+	Reactive power < 0, stages disconnection		The device has generated an Alarm
↑	Installation generating		Setup menu: Setup screen in display mode. Setup screen in edit mode.
↓	Installation consuming		
RUN	Device in measurement and regulation mode	MAX	Maximum value
SETUP	Programming screen	MIN	Minimum value
	Communications enabled		

- ✓ The **Capacitor status area**, which shows the status of the relays (stages) on the device, and therefore the capacitors connected to it.

The possible states are:

- Nothing is displayed if the stage is not connected and set to *AUTO*.
- The **1** icon is displayed if the stage is connected and set to *AUTO*.
- The **1** icon is displayed, with the bottom bar fixed, if the stage is connected and set to *on*.
- Only the fixed bottom bar is displayed if the stage is disconnected and set to *OFF*.

The setup menu ("**6.10.1 - STATUS OF THE STAGES**") is used to select the status of the stages. The possible options are:

- ✓ **AUTO**, The status of the stage is determined automatically by the device.
- ✓ **on**, stage forced ON, always connected.
- ✓ **off**, stage forced OFF, always disconnected.

By default, all the stages are set to **AUTO**.

The device's display can change colour, indicating:



Yellow: The device has generated an E01, E02, E03, E05, E06, E07, E09 or E10 alarm. See "**5.1.2 - ALARMS**".



Red: The device has generated an E04 alarm, **Overvoltage alarm** or E08, **THD voltage high** alarm. See "**5.1.2 - ALARMS**".

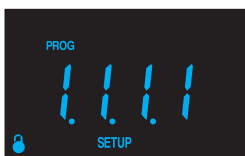



Blue: Device in configuration mode.

4.4 - KEYBOARD FUNCTIONS

The **iPFC max** has 3 keys to navigate through the different screens and program the device.

Function of the keys (**Table 7**):

Table 7: Function of the keys on display screens.

Key	Short keystroke	Long keystroke (3s)
	Next screen	Connecting the capacitors
	Previous screen	Disconnecting the capacitors
	Display of maximum and minimum values	Access to setup menu.

4.5 - ALARM RELAY

The **iPFC max** has 1 alarm relay (terminals 13 and 14 in **Table 3** and **Table 4**) that trips when an alarm is triggered. Alarms can be enabled and disabled in the advanced setup (see "**6.10.8 - ENABLING THE NO CURRENT ALARM (E01)**")

5 - DISPLAY

When starting the device, the initial screen is displayed, showing the version of the device, **Figure 7**, and after 3 seconds, the home screen.

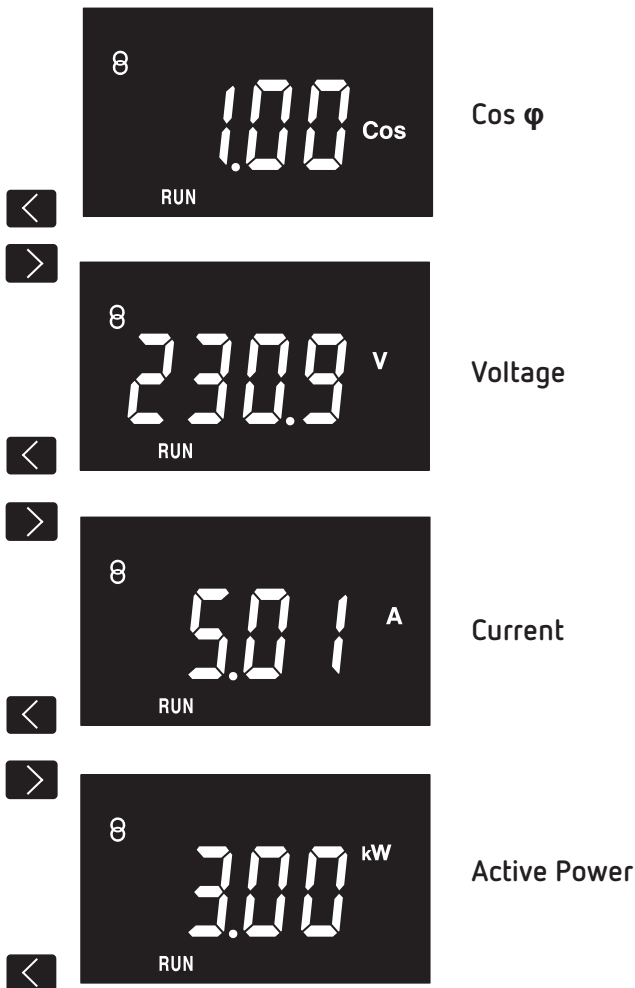

Figure 7: Home Screen.

5.1 - DISPLAY SCREENS

Use the keys  and  to browse through the different screens.

Note: If no key is pressed for 3 minutes, the device goes to the **Cos φ** display screen.



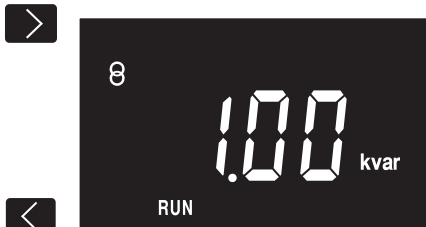

Reactive Power

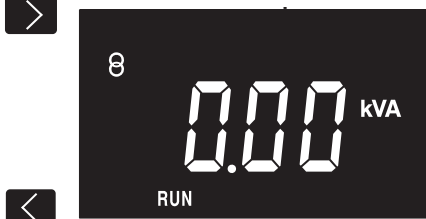

Apparent Power

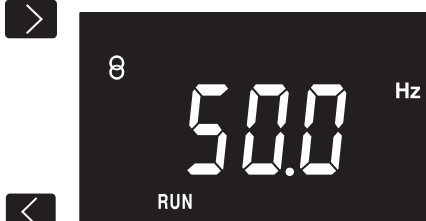

Frequency

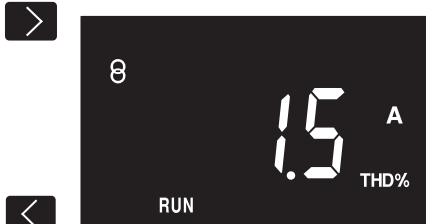

Current THD

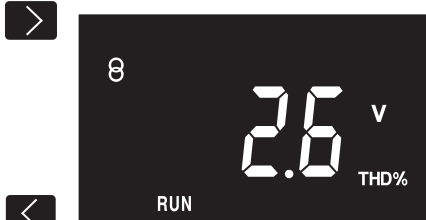

Voltage THD



Operations counter for each stage.

Press the key to display the counters.

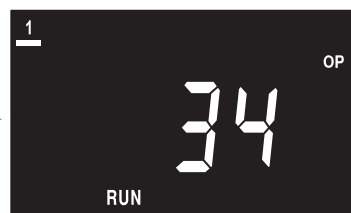



Press the keys and to change stages.



Note: Press the keys > 3s to reset the operations counter.





Hours of operation

Note: Press the keys   > 3s to reset the hours since the last maintenance.

If 9000 hours of operation have been exceeded since the last maintenance, the icon  is shown on the display, indicating that it is necessary to carry out maintenance on the device. Once done, it is necessary to reset the alarm by pressing the   keys.

If the device is connected with the **MyConfig** application, it will be necessary to carry out this reset to disable the Annual Maintenance alarm.

5.1.1 - MAXIMUM & MINIMUM VALUES

When viewing a screen, press the  key to show the maximum and minimum values for the parameter.

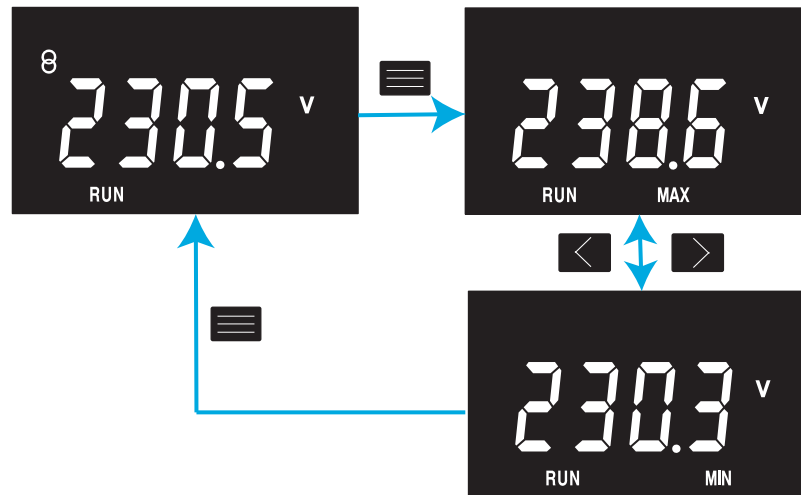



Figure 8: Display of maximum and minimum values.

If, while viewing the maximum and minimum values, the   keys are pressed for > 3s, the maximum and minimum values are reset.

5.1.2 - ALARMS

If there is an alarm, the display changes colour and when viewing the **Cos φ** screen, the alarm screens are shown, displaying the active alarm codes (Table 8).





Figure 9: Alarm screen.

Table 8: Alarm code.

Code	Display Colour	Default state	Description
E01	Yellow	Enabled	No current. The charging current is lower than the minimum value or the current transformer (CT) is not connected. Activated when the secondary current on the transformer is less than 50 mA. The device automatically disconnects the capacitors.
E02	Yellow	Disabled	Overcompensation. The device measures capacitive power but all the stages are disconnected. May be due to an improperly set C/K parameter. To avoid potential false actuations, this alarm has a fixed delay of 90 seconds.
E03	Yellow	Enabled	Overcurrent. The measured current exceeds the rated current by over 20%. The rated current is the primary current of the CT. To avoid potential false actuations, this alarm has a fixed delay of 5 seconds.
E04	Red	Enabled	Overvoltage. The measured voltage exceeds the supply voltage by +15%. The device automatically disconnects the capacitors. To avoid potential false actuations, this alarm has a preset delay of 5 seconds.
E05	Yellow	Enabled	Low voltage. The voltage is lower than the supply voltage by -15%. The device automatically disconnects the capacitors. To avoid potential false actuations, this alarm has a preset delay of 1 second.
E06	Yellow	Disabled	Cos ϕ high alarm. Cos ϕ is outside the limits set in the Cos ϕ high alarm. And the measured currents must be above the specified threshold. To avoid potential false actuations, this alarm has a fixed delay of 5 minutes.
E07	Yellow	Disabled	Cos ϕ low alarm. Cos ϕ is outside the limits set in the Cos ϕ low alarm. And the measured currents must be above the specified threshold. To avoid potential false actuations, this alarm has a fixed delay of 5 minutes.
E08	Red	Enabled (8%)	THD voltage high alarm. The THD voltage levels are above those specified for the THD voltage high alarm. The device automatically disconnects the capacitors. To avoid potential false actuations, this alarm has a preset delay of 30 seconds.
E09	Yellow	Enabled (5%)	THD voltage low alarm. The THD voltage levels are above those specified for the THD voltage low alarm. To avoid potential false actuations, this alarm has a preset delay of 30 minutes. This alarm functions as a pre-alarm for the THD voltage high alarm.
E10	Yellow	Enabled	Internal device error. The device has detected an internal error.

5.1.3 - CONNECTING/DISCONNECTING THE CAPACITORS MANUALLY

While any display screen is shown, if the:

- ✓  key is pressed, **the device starts to disconnect the capacitors** (the key must be held down). During this process, the capacitor icons flash and turn off as they are disconnected. If the key is released, after 20 seconds, the icons stop flashing and the device status returns to normal.
- ✓  key is pressed, **the device starts to connect the capacitors** (the key must be held down). During this process, the capacitor icons flash and turn on as they are connected. If the key is released, after 20 seconds, the icons stop flashing and the device status returns to normal.

6 - CONFIGURATION

The device's various configuration parameters can be viewed and edited in the setup menu. The device always keeps the capacitors disconnected (except in Plug & Play).

This status is identified by the blue color of the display, and by the symbol **SETUP** in the device status display area.

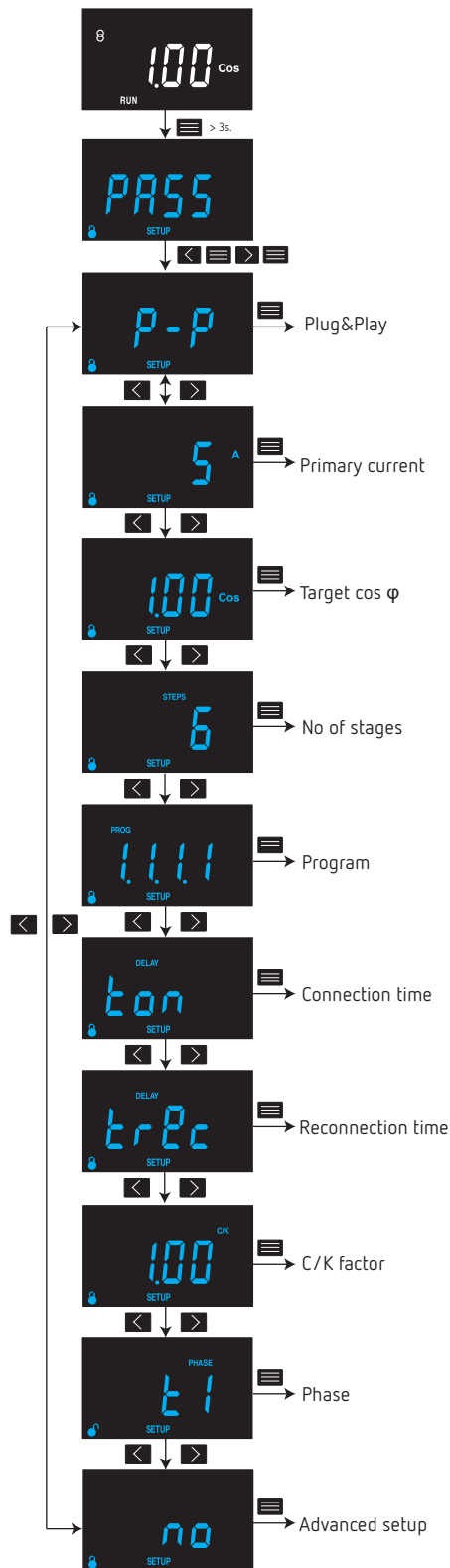

Figure 10: Setup menu.





To enter the setup menu, press the key  for > 3s.
The display shows the password screen, **Figure 11**.



Figure 11: Password Screen.

The password to enter is a combination of keys:    . It is unique and cannot be configured.

If entered incorrectly, the device returns to the measurement screen that was being displayed.
If entered correctly and capacitors are connected, the disconnect screen is displayed.



Figure 12: Disconnect screen.

The disconnect screen is used to automatically disconnect all the stages from the device before going into the settings.

While in this screen, the device ignores any keyboard inputs.

Note: The screen in **Figure 13** is shown when a configuration value has been saved.



Figure 13: SAVE screen.

Note: The screen in **Figure 14** is shown when the configured value is incorrect or the user exits the setup menu without saving.

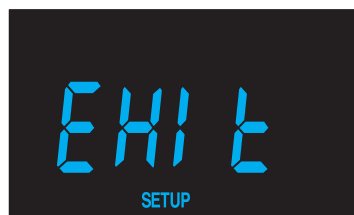

Figure 14: EXIT screen.

Note: The setup menu tree is shown in "ANNEX A - SETUP MENU"

6.1 - PLUG&PLAY

Plug & Play is of use when setting up the device, since it automatically configures the basic parameters that are needed for the device to provide proper regulation.

To start the Plug & Play process, press the key .

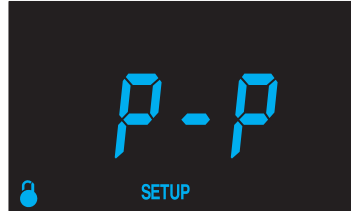

Once started, the digits flash and the device starts a process of connecting and disconnecting the capacitors, measuring and calculating to obtain the following stage parameters:

- ✓ Phase,
- ✓ C/K Factor

These parameters can be set manually from their respective screens.

To stop the process, press the key  for > 3s

Once the Plug & Play process is complete, if no errors occurred, the device returns to the measurement and regulation mode (**RUN**) and shows the display screen when the key  is pressed.

If there was an error during the process, the following screen will be shown:

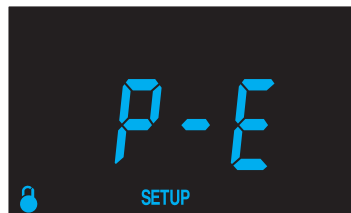

Press the key  to exit the screen.

Plug & Play is designed to aid with the installation of the reactive energy compensation system, with the initial configuration of the regulator or if changes are made to the system (new regulator, new wiring, new stage, etc.). To do this, any potential problems involving faulty capacitors must be solved, either through maintenance or replacement, before the Plug & Play process, and all the stages must be set to **Auto** mode, which is how they are configured by default.

Conditions needed for Plug & Play to work correctly:



- ✓ The system's cosine must be between 0.62 and 0.99 inductive during the process.
- ✓ The power in the system must be stable. There must be no major load changes (> 10% in under 20 seconds), as this would cause the power of the capacitors to be miscalculated.
- ✓ There must be sufficient current in the system, above 100 mA AC at the input to the regulator.
- ✓ If the load is unbalanced, the proper operation of the Plug & Play will depend on the phase where the current transformer was connected.



Once the Plug & Play process is complete, in order for the device to properly measure the current and power, the primary of the current transformer must be configured.

Use the keys  and  to access the next configuration parameter.

Press the key  for > 3s to exit the setup menu.

If no key is pressed for 3 minutes, the device goes to the **Cos φ** display screen.

6.2 - PRIMARY CURRENT

This screen is used to configure the installation's primary current.



Press the key  to configure the parameter.

Use the keys  and  to modify the digit's value.

Press the key  keys to skip the digit.

Maximum value: 9999 A

Minimum value: 5 A

If the  key is pressed over the last digit, the value is validated and saved.

If the value entered is below the minimum value or above the maximum value, the value entered is replaced by the last validated value.

Use the keys  and  to access the next configuration parameter.





Press the key  for > 3s to exit the setup menu.

If no key is pressed for 3 minutes, the device goes to the **Cos φ** display screen.

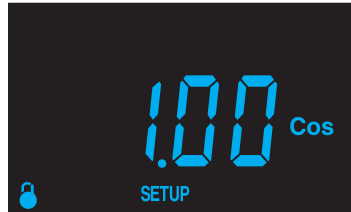
6.3 - TARGET COS φ

Cos φ is used to specify the desired power factor in the installation. The **iPFC max** will insert the number of capacitors needed to approach this target value as much as possible. Since power correction is done one stage at a time, the device will not take any action until the uncorrected demand is at least 70% of the power of the smallest stage, or until the excess correction is 70% of the power of the smallest stage.



Press the key  to configure the parameter.
 Use the keys  and  to modify the digit's value.
 Press the key  key to skip digits.

Maximum value: 1.00

Minimum value: 0,50

If the  key is pressed over the last digit, the value is validated and saved.

If the value entered is below the minimum value or above the maximum value, the value entered is replaced by the last validated value.

Use the keys  and  to access the next configuration parameter.





Press the key  for > 3s to exit the setup menu.

If no key is pressed for 3 minutes, the device goes to the **Cos φ** display screen.

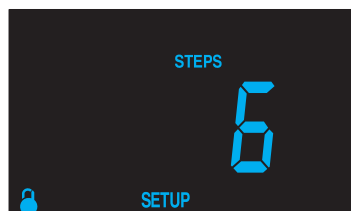
6.4 - No. OF STAGES

At this point, the number of stages is selected, i.e., the number of relay outputs that the device will have. Six or 12 outputs can be set up, depending on the model (**iPFC max6** or **iPFC max12**).



Press the key  to configure the parameter.
 Use the keys  and  to modify the digit's value.
 Press the key  keys to skip the digit.

Maximum value: 6 (iPFC max6) - 12 (iPFC max12)

Minimum value: 0

If the  key is pressed over the last digit, the value is validated and saved.

If the value entered is below the minimum value or above the maximum value, the value entered is replaced by the last validated value.

Use the keys  and  to access the next configuration parameter.

Press the key  for > 3s to exit the setup menu.

If no key is pressed for 3 minutes, the device goes to the **Cos φ** display screen.

6.5 - PROGRAM

The device consists of stages with different powers. The base power (value 1) is that of the stage with the lowest power. The powers of the other stages are given in relation to the first.

Example:

Program 1.1.1.1, all the stages have the same power as the first.

Program 1.2.4.4, the 2nd stage has twice the power, and subsequent stages, 4 times the power of the first. (See "4.1.4 - REGULATION PROGRAM")



When configuring the program, it is important to remember that the next stage cannot be lower than the preceding one, and that the first one is always 1.

Press the key  to configure the parameter.

Use the keys  and  to modify the digit's value.

Press the key  keys to skip the digit.

Maximum value: 1.9.9.9

Minimum value: 1.1.1.1

If the  key is pressed over the last digit, the value is validated and saved.

If the value entered is below the minimum value or above the maximum value, the value entered is replaced by the last validated value.

Use the keys  and  to access the next configuration parameter.





Press the key  for > 3s to exit the setup menu.

If no key is pressed for 3 minutes, the device goes to the **Cos φ** display screen.

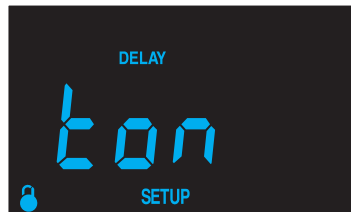
6.6 - CONNECTION TIME

This is where the minimum time between connection and disconnection the same stage is configured.



Press the key  to configure the parameter.
 Use the keys  and  to modify the digit's value.
 Press the key  keys to skip the digit.

Maximum value: 99 s.

Minimum value: 4 s.

If the  key is pressed over the last digit, the value is validated and saved.

If the value entered is below the minimum value or above the maximum value, the value entered is replaced by the last validated value.

Use the keys  and  to access the next configuration parameter.





Press the key  for > 3s to exit the setup menu.

If no key is pressed for 3 minutes, the device goes to the **Cos φ** display screen.

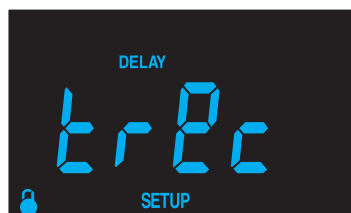
6.7 - RECONNECTION TIME

This is where the minimum time between disconnecting and reconnecting the same stage is specified. t_{rec} must be longer than t_{on} , ideally 5 times longer.



Press the key  to configure the parameter.
 Use the keys  and  to modify the digit's value.
 Press the key  keys to skip the digit.

Maximum value: 999 s.

Minimum value: 20 s.

If the  key is pressed over the last digit, the value is validated and saved.

If the value entered is below the minimum value or above the maximum value, the value entered is replaced by the last validated value.

Use the keys  and  to access the next configuration parameter.

Press the key  for > 3s to exit the setup menu.

If no key is pressed for 3 minutes, the device goes to the **Cos φ** display screen.

6.8 - C/K FACTOR

The C/K factor is adjusted based on the reactive current provided by the smallest stage, measured at the secondary of the current transformer (CT). Its adjustment value thus depends on the power of the lower stage, the ratio of the CT and the mains voltage.

Table 9 and Table 10 give the values to which C/K must be adjusted for a 400V AC mains between phases, different transformer ratios and powers of the smallest stage.

Table 9: C/K factor (table 1).

CT ratio (Ip / Is)	Power of the smallest stage at 400V (in kvar)													
	2.5	5.0	7.5	10.0	12.5	15.0	20.0	25.0	30.0	40.0	50.0	60.0	75.0	80.0
150/5	0.12	0.24	0.36	0.48	0.60	0.72	0.96							
200/5	0.09	0.18	0.27	0.36	0.45	0.54	0.72	0.90						
250/5	0.07	0.14	0.22	0.29	0.36	0.43	0.58	0.72	0.87					
300/5	0.06	0.12	0.18	0.24	0.30	0.36	0.48	0.60	0.72	0.96				
400/5	0.05	0.09	0.14	0.18	0.23	0.24	0.36	0.48	0.58	0.72	0.87			
500/5		0.07	0.11	0.14	0.18	0.22	0.29	0.36	0.45	0.54	0.72	0.87		
600/5		0.06	0.09	0.12	0.15	0.18	0.24	0.30	0.36	0.48	0.60	0.72	0.90	0.96
800/5			0.07	0.09	0.11	0.14	0.18	0.23	0.27	0.36	0.45	0.54	0.68	0.72
1000/5			0.05	0.07	0.09	0.11	0.14	0.18	0.22	0.29	0.36	0.43	0.54	0.57
1500/5				0.05	0.06	0.07	0.10	0.12	0.14	0.19	0.24	0.29	0.36	0.38
2000/5						0.05	0.07	0.09	0.11	0.14	0.18	0.22	0.27	0.28
2500/5							0.06	0.07	0.09	0.12	0.14	0.17	0.22	0.23
3000/5							0.05	0.06	0.07	0.10	0.12	0.14	0.18	0.19
4000/5									0.05	0.07	0.09	0.11	0.14	0.14

If the capacitor at 440V is used as a reference for a 400V mains voltage, use Table 10.

Table 10: C/K factor (table 2).

CT ratio (Ip / Is)	Power of the smallest stage at 440V (in kvar)													
	2.5	5.0	7.5	10.0	12.5	15.0	20.0	25.0	30.0	40.0	50.0	60.0	75.0	80.0
150/5	0.09	0.18	0.27	0.36	0.45	0.54	0.72	0.90						
200/5	0.07	0.14	0.20	0.27	0.34	0.41	0.54	0.68	0.81					
250/5	0.05	0.11	0.16	0.22	0.27	0.33	0.43	0.54	0.65	0.87				
300/5	0.05	0.09	0.14	0.18	0.23	0.27	0.36	0.45	0.54	0.72	0.90			
400/5		0.07	0.10	0.14	0.17	0.20	0.27	0.34	0.41	0.54	0.68	0.81		
500/5		0.05	0.08	0.11	0.14	0.16	0.22	0.27	0.33	0.43	0.54	0.65	0.81	0.87
600/5		0.05	0.07	0.09	0.11	0.14	0.18	0.23	0.27	0.36	0.45	0.54	0.68	0.72

Table 10 (continued): C/K factor (table 2).

CT ratio (I _p / I _s)	Power of the smallest bank at 440V (in kvar)													
	2.5	5.0	7.5	10.0	12.5	15.0	20.0	25.0	30.0	40.0	50.0	60.0	75.0	80.0
800/5			0.05	0.07	0.08	0.10	0.14	0.17	0.20	0.27	0.34	0.41	0.51	0.54
1000/5			0.04	0.05	0.07	0.08	0.11	0.14	0.16	0.22	0.27	0.33	0.41	0.43
1500/5				0.04	0.05	0.05	0.07	0.09	0.11	0.14	0.18	0.22	0.27	0.29
2000/5						0.04	0.05	0.07	0.08	0.11	0.14	0.16	0.20	0.22
2500/5							0.04	0.05	0.07	0.09	0.11	0.13	0.16	0.17
3000/5							0.04	0.05	0.05	0.07	0.09	0.11	0.14	0.14
4000/5									0.04	0.05	0.07	0.08	0.10	0.11

For other voltages or conditions not included in the table, the value of C/K can be obtained using a simple calculation.

✓ C/K factor calculation

The equation for calculating the C/K factor is:

$$C/K = \frac{I_c}{K}$$

where, **I_c**: is the current of the smallest capacitor.

K: the transformation ratio of the current transformer.

To calculate **I_c**, you need to know the reactive power of the smallest capacitor **Q** and the mains voltage **V**.

$$I_c = \frac{Q}{\sqrt{3}V}$$

The transformation ratio K is calculated as:

$$K = I_{prim}/I_{sec}$$

where, **I_{prim}**: is the nominal current in the primary of the transformer.

I_{sec}: is the current in the secondary of the transformer.

Example: In a 400V device, the smallest capacitor is 60 kvar with a current transformer ratio of 500/5. The calculation would be as follows:

Current of the smallest capacitor, I_c:
$$I_c = \frac{60000}{\sqrt{3} * 400}$$

K Factor
$$K = 500/5 = 100$$

The value of C/K is: **0.866**.

If the power of 60 kvar is referenced to 440V, it must be multiplied by $V_{red}^2/440^2$ with the value C/K in the above example being **0.72**.







If C/K is set below its actual value, there will be constant connections and disconnections with low load variations (the system takes action more often than necessary).

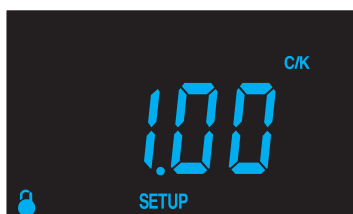

If C/K is set higher, the regulator needs a higher reactive power demand to switch and is actuated less.



Press the key  to configure the parameter.
Use the keys  and  to modify the digit's value.
Press the key  keys to skip the digit.

Maximum value: 1.00

Minimum value: 0.02

If the  key is pressed over the last digit, the value is validated and saved.

If the value entered is below the minimum value or above the maximum value, the value entered is replaced by the last validated value.

Use the keys  and  to access the next configuration parameter.

Press the key  for > 3s to exit the setup menu.

If no key is pressed for 3 minutes, the device goes to the **Cos φ** display screen.

6.9 - PHASE CONNECTION

This parameter is used to adapt the device to the different options for connecting the power and measurement cables. Specifically, this screen is used to select one of the 6 possible phases shown in **Table 11**.

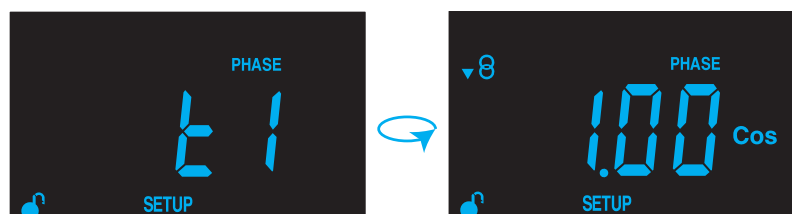

Press the key  to configure the parameter.
The phase selection screen alternates with the screen showing **cos φ** .

The phase connection must be made when the installation is consuming inductive reactive power with a $\cos \varphi$ between 0.6 and 1.

View the options until the $\cos \varphi$ screen shows a value between 0.6 and 1 (the $\cos \varphi$ display is for information purposes only and cannot be edited).

Use the keys  and  to skip through the different options.

Table 11: Phase connection options.

Phase	Phase shift V-I at $\cos \varphi = 1$	V measurement phases	CT connection phase
t1	30°	L3-L2	L3
t2	270°	L3-L2	L1
t3	150°	L3-L2	L2
t4	210°	L3-L2	L3 (Inverted transformer)
t5	90°	L3-L2	L1 (Inverted transformer)
t6	330°	L3-L2	L2 (Inverted transformer)

When the  key is pressed, the option specified is validated and saved.

Use the keys  and  to access the next configuration parameter.

Press the key  for > 3s to exit the setup menu.

If no key is pressed for 3 minutes, the device goes to the $\cos \varphi$ display screen.

6.10 - ADVANCED SETUP

At this point, you can decide if you want to access the advanced setup menu.



Press the key  to select whether to access the advanced setup or not.

Use the keys  and  to skip through the different options: **No** or **Yes**.

When the  key is pressed, the option specified is validated and saved.

If **No** is selected, the menu goes back to the configuration parameter: "6.1 - PLUG&PLAY"

If **Yes** is selected, the stage status configuration screen is shown: "6.10.1 - STATUS OF THE STAGES"

6.10.1 - STATUS OF THE STAGES

This parameter is repeated for each of the 6 or 12 possible stages, and provides the option to force their status regardless of the operation being carried out by the device itself.



Press the key  to access the stage configuration options.



To distinguish which of the 12 steps we are configuring, the screen uses the icon .

Use the keys  and  to skip through the different stages.

Press the key  to configure the selected stage.

The configuration options for each stage are:

- ✓ *AUTO*, The status of the step depends on the maneuver performed by the device.
- ✓ *ON*, stage forced ON, always connected.
- ✓ *OFF*, stage forced OFF, always disconnected.

By default, all the stages are set to *AUTO*.

Use the keys  and  to skip through the different options.

When the  key is pressed, the option specified is validated and saved.

Press the key  for > 3s to exit the setup menu for the stages.

Use the keys  and  to access the next advanced configuration parameter.

Press the key  for > 3s to exit the setup menu.



If no key is pressed for 3 minutes, the device goes to the **Cos φ** display screen.

6.10.2 - COS φ HIGH ALARM

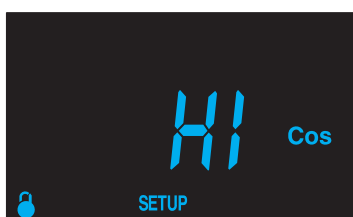
The high limit of the **cos φ** alarm (E06) is set at this point. It is activated whenever the value of **cos φ** is above the specified value.



Press the key  to configure the parameter.

Use the keys  and  to modify the digit's value.
Press the key  keys to skip the digit.

Maximum value: 1.00

Minimum value: 0.00

If the  key is pressed over the last digit, the value is validated and saved.

If the value entered is below the minimum value or above the maximum value, the value entered is replaced by the last validated value.

Use the keys  and  to access the next advanced configuration parameter.

Press the key  for > 3s to exit the setup menu.

If no key is pressed for 3 minutes, the device goes to the **Cos φ** display screen.

6.10.3 - COS φ LOW ALARM

The low limit of the **cos φ** alarm (E07) is set at this point. It is activated whenever the value of **cos φ** is below the specified value.

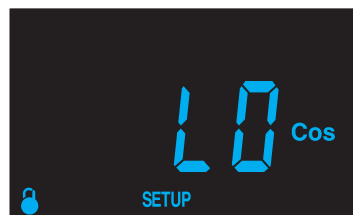

Press the key  to configure the parameter.

Use the keys  and  to modify the digit's value.

Press the key  keys to skip the digit.

Maximum value: 1.00

Minimum value: 0.00

If the  key is pressed over the last digit, the value is validated and saved.

If the value entered is below the minimum value or above the maximum value, the value entered is replaced by the last validated value.

Use the keys  and  to access the next advanced configuration parameter.





Press the key  for > 3s to exit the setup menu.

If no key is pressed for 3 minutes, the device goes to the **Cos φ** display screen.

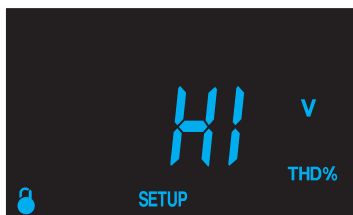
6.10.4 - THD VOLTAGE HIGH ALARM

At this point, the threshold above which the THD voltage high alarm (**E08**) is activated is configured. If the device exceeds this value for 30 seconds, alarm **E08** is triggered.





Press the key  to configure the parameter.
Use the keys  and  to modify the digit's value.
Press the key  keys to skip the digit.

Maximum value: 99.9%

Minimum value: 00,0%

If the  key is pressed over the last digit, the value is validated and saved.

If the value entered is below the minimum value or above the maximum value, the value entered is replaced by the last validated value.





Use the keys  and  to access the next advanced configuration parameter.
Press the key  for > 3s to exit the setup menu.

If no key is pressed for 3 minutes, the device goes to the **Cos φ** display screen.

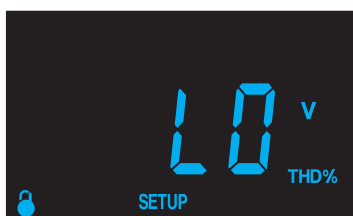
6.10.5 - THD VOLTAGE LOW ALARM

At this point, the threshold below which the THD voltage low alarm (**E09**) is activated is configured. If the device is exceeds this value for 30 minutes, alarm **E09** is triggered.
This alarm functions as a pre-alarm for the THD voltage high alarm.





Press the key  to configure the parameter.
Use the keys  and  to modify the digit's value.
Press the key  keys to skip the digit.

Maximum value: 99.9%

Minimum value: 00,0%

If the  key is pressed over the last digit, the value is validated and saved.

If the value entered is below the minimum value or above the maximum value, the value entered is replaced by the last validated value.





Use the keys  and  to access the next advanced configuration parameter.
Press the key  for > 3s to exit the setup menu.

If no key is pressed for 3 minutes, the device goes to the **Cos φ** display screen.

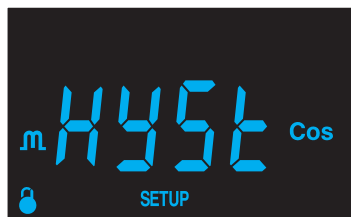
6.10.6 - INDUCTIVE VALUE OF HYSTERESIS

The inductive hysteresis value of the target **cos φ** is specified in this section. As long as **cos φ** is within this range, the device does not connect any steps, but it can disconnect them.





Press the key  to configure the parameter.
Use the keys  and  to modify the digit's value.
Press the key  keys to skip the digit.

Maximum value: 0.05

Minimum value: 0.00

If the  key is pressed over the last digit, the value is validated and saved.

If the value entered is below the minimum value or above the maximum value, the value entered is replaced by the last validated value.

Use the keys  and  to access the next advanced configuration parameter.
Press the key  for > 3s to exit the setup menu.

If no key is pressed for 3 minutes, the device goes to the **Cos φ** display screen.

6.10.7 - CAPACITIVE VALUE OF HYSTERESIS

The capacitive hysteresis value of the target **cos φ** is specified in this section. As long as **cos φ** is within this range, the device does not connect any steps, but it can disconnect them.

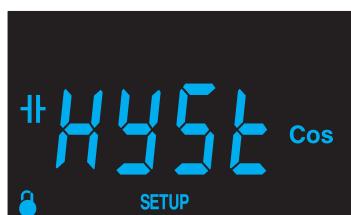

Press the key  to configure the parameter.

Use the keys  and  to modify the digit's value.

Press the key  keys to skip the digit.

Maximum value: 0.05

Minimum value: 0.00

If the  key is pressed over the last digit, the value is validated and saved.

If the value entered is below the minimum value or above the maximum value, the value entered is replaced by the last validated value.

Use the keys  and  to access the next advanced configuration parameter.

Press the key  for > 3s to exit the setup menu.

If no key is pressed for 3 minutes, the device goes to the **Cos φ** display screen.

6.10.8 - ENABLING THE NO CURRENT ALARM (E01)

The no current alarm (E01) is enabled or disabled in this section.

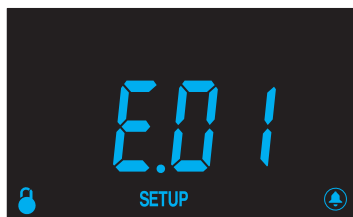

Press the key  to access the alarm settings.

Use the keys  and  to skip through the different options: **Yes** or **No**

When the  key is pressed, the option specified is validated and saved.

Use the keys  and  to access the next advanced configuration parameter.

Press the key  for > 3s to exit the setup menu.

If no key is pressed for 3 minutes, the device goes to the **Cos φ** display screen.

6.10.9 - ENABLING THE OVERCOMPENSATION ALARM (E02)

This alarm is enabled in the same way as the alarm in section "**6.10.8 - ENABLING THE NO CURRENT ALARM (E01)**".

6.10.10 - ENABLING THE OVERCURRENT ALARM (E03)

This alarm is enabled in the same way as the alarm in section "**6.10.8 - ENABLING THE NO CURRENT ALARM (E01)**".

6.10.11 - ENABLING THE OVERVOLTAGE ALARM (E04)

This alarm is enabled in the same way as the alarm in section "**6.10.8 - ENABLING THE NO CURRENT**

ALARM (E01)".

6.10.12 - ENABLING THE LOW VOLTAGE ALARM (E05)

This alarm is enabled in the same way as the alarm in section "*6.10.8 - ENABLING THE NO CURRENT ALARM (E01)"*.

6.10.13 - ENABLING THE COS φ LOW ALARM (E07)

This alarm is enabled in the same way as the alarm in section "*6.10.8 - ENABLING THE NO CURRENT ALARM (E01)"*.

6.10.14 - ENABLING THE COS φ HIGH ALARM (E06)

This alarm is enabled in the same way as the alarm in section "*6.10.8 - ENABLING THE NO CURRENT ALARM (E01)"*.

6.10.15 - ENABLING THE THD VOLTAGE HIGH ALARM (E08)

This alarm is enabled in the same way as the alarm in section "*6.10.8 - ENABLING THE NO CURRENT ALARM (E01)"*.

6.10.16 - ENABLING THE THD VOLTAGE LOW ALARM (E09)



This alarm is enabled in the same way as the alarm in section "*6.10.8 - ENABLING THE NO CURRENT ALARM (E01)"*.

6.10.17 - ENABLING THE INTERNAL ERROR ALARM (E10)

This alarm is enabled in the same way as the alarm in section "*6.10.8 - ENABLING THE NO CURRENT ALARM (E01)"*.

7 - TECHNICAL SPECIFICATIONS

AC Power supply		
Connection	Connect preferably to phase L2-L3	
Rated voltage	400 V ~ ± 10%	
Frequency	50... 60 Hz	
Consumption	13 VA	
Installation category	CAT III 300V	
Voltage measurement circuit		
Connection	Connect preferably to phase L2-L3	
Rated voltage (Un)	400 V ~	
Voltage measurement margin	- 10%... +10%	
Frequency measurement margin	50... 60 Hz	
Installation category	CAT III 300V	
Current measurement circuit		
Connection	Connect preferably to phase L1	
Rated current (In)	.../5A	
Current measurement margin	0,05... 5A (Maximum overload + 20%)	
Installation category	CAT III 300V	
Measurement accuracy		
Voltage measurement	1%	
Current measurement	1%	
cos φ measurement	2% ± 1 digit	
Relay outputs		
	iPFC max6	iPFC max12
Quantity	6 + 1 (Alarm)	12 + 1 (Alarm)
Maximum switching voltage	250 V~	
Maximum current	1 A ~	
Maximum switching power	250 W	
Electrical life (maximum load)	1x10 ⁵ Cycles	
Mechanical life	1x10 ⁷ Cycles	
User interface		
Display	4 digits	
Keyboard	3 keys	
Environmental features		
Operating temperature	-20 °C ... +60°C	
Storage temperature	-20 °C ... +70 °C	
Relative humidity (without condensation)	5 ... 95%	
Maximum altitude	2000 m	
Protection degree IP	IP30, Frontal: IP40	
Protection degree IK	IK08	
Pollution degree	2	
Use	Indoor	
Safety category	Class II 	

Mechanical features			
			
Terminals	$\geq 1.5 \text{ mm}^2$	0.5 Nm	flat
Dimensions	Figure 15 (mm)		
Weight	iPFC max6	447 g.	
	iPFC max12	500 g.	
Enclosure	Self-extinguishing V0 plastic		
Attachment	Panel		
Standards			
Safety requirements for electrical equipment for measurement, control, and laboratory use Part 1: General requirements.		UNE EN 61010-1	
Safety requirements for electrical equipment for measurement, control, and laboratory use Part 2-030: Particular requirements for testing and measuring circuits.		UNE-EN 61010-2-030	
Electromagnetic Compatibility (EMC) Part 6-4: General standards. Emission standard for industrial environments.		UNE-EN 61000-6-4	
Electromagnetic compatibility (EMC) Part 6-2: General standards. Immunity standard for industrial environments.		UNE-EN 61000-6-2	
Environmental testing -- Part 2-1: Tests - Test A: Cold		UNE-EN 60068-2-1	
Environmental testing -- Part 2-2: Tests - Tests B: Dry heat.		UNE-EN 60068-2-2	
Environmental testing - Part 2-78: Tests - Test Cab: Damp heat, steady state		UNE-EN 60068-2-78	

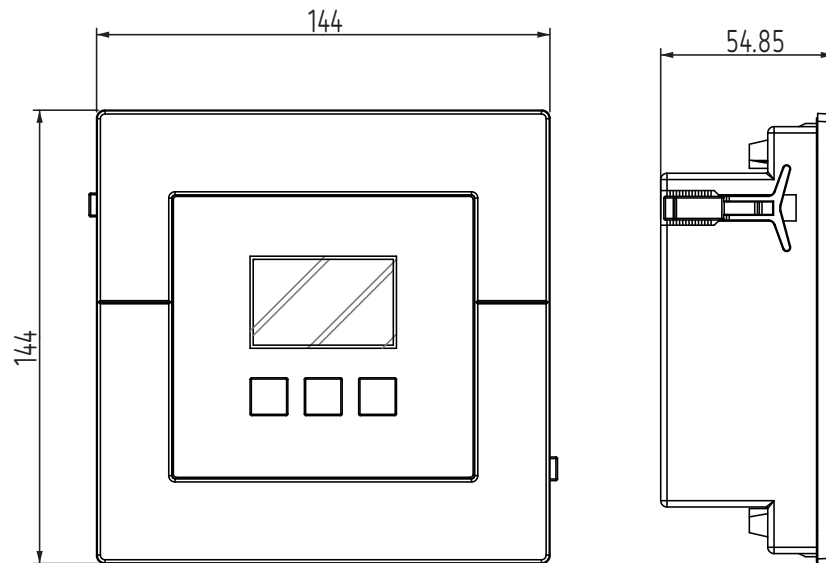

Figure 15: Dimensions iPFC max.

8 - MAINTENANCE AND TECHNICAL SERVICE

In the case of any query in relation to device operation or malfunction, please contact the **Iskra** Technical Support Service.

Technical Assistance Service

Stegne 21, 1000 Ljubljana, Slovenia

email: experts@iskra.eu

9 - GUARANTEE

Iskra guarantees its products against any manufacturing defect for two years after the delivery of the units.

Iskra will repair or replace any defective factory product returned during the guarantee period.



- No returns will be accepted and no unit will be repaired or replaced if it is not accompanied by a report indicating the defect detected or the reason for the return.
- The guarantee will be void if the units has been improperly used or the storage, installation and maintenance instructions listed in this manual have not been followed. "Improper usage" is defined as any operating or storage condition contrary to the national electrical code or that surpasses the limits indicated in the technical and environmental features of this manual.
- **Iskra** accepts no liability due to the possible damage to the unit or other parts of the installation, nor will it cover any possible sanctions derived from a possible failure, improper installation or "improper usage" of the unit. Consequently, this guarantee does not apply to failures occurring in the following cases:
 - Overvoltages and/or electrical disturbances in the supply;
 - Water, if the product does not have the appropriate IP classification;
 - Poor ventilation and/or excessive temperatures;
 - Improper installation and/or lack of maintenance;
 - Buyer repairs or modifications without the manufacturer's authorisation.

ANNEX A - SETUP MENU

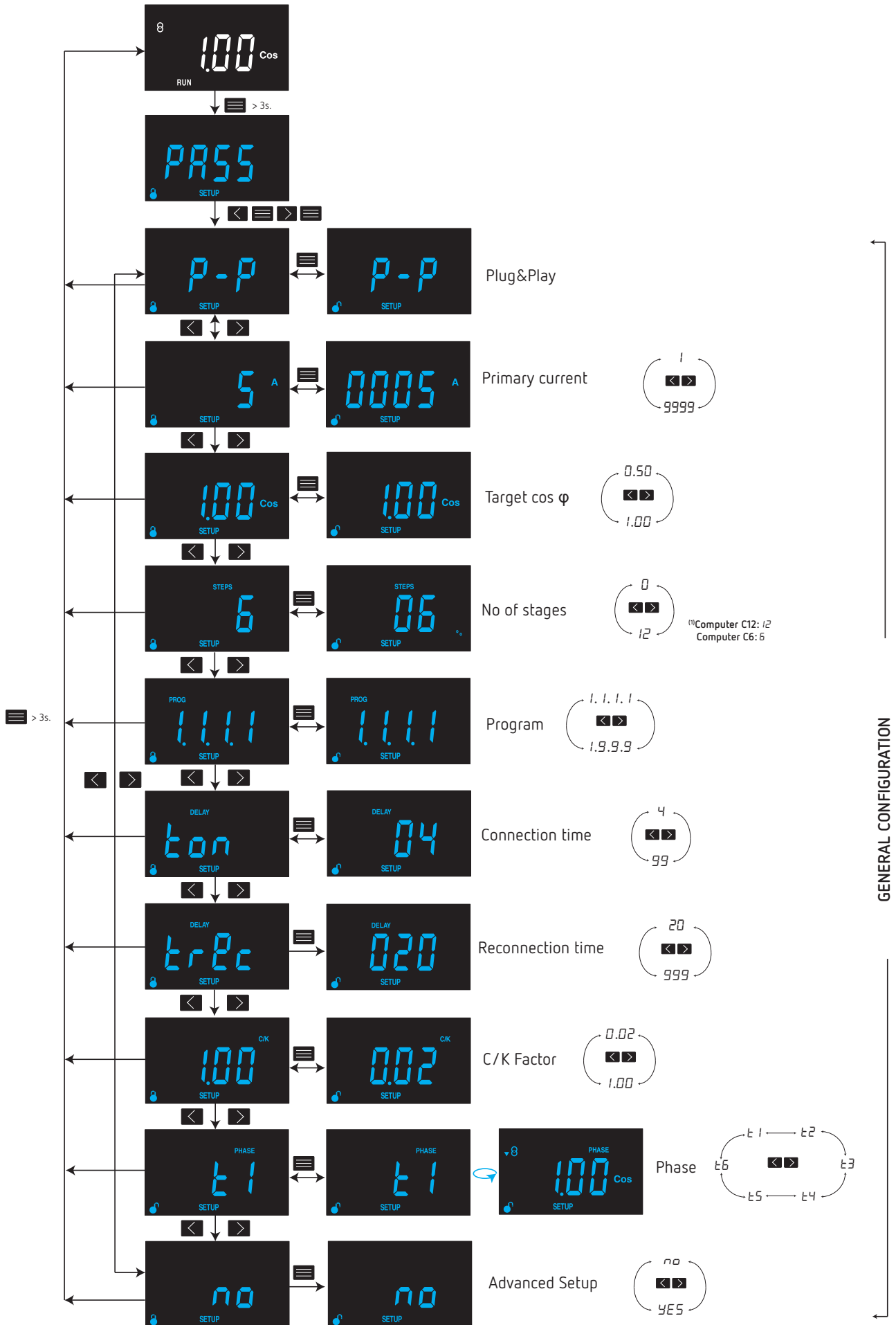

GENERAL CONFIGURATION

