

High-torque Intelligent Soft Starter SJR2000
Operation manual



Shanyu

Softstart

Forward

Thank you for your purchasing our “SJR2” motor soft starter, which is used to soft start and soft stop the three-phase asynchronous motor. Before use, please read carefully and fully understand the instruction, so that you can operate it correctly.



Safety consideration

Please read this manual carefully to get the best performance of the soft starter. Please do not change the set value if it is not necessary, as the change will affect its function and performance. Please ask professional workers to modify the parameter of the soft starter if it is necessary.

Only professional workers are allowed to install SJR2.

Please make sure that the motor is equipped with the right SJR2 that with corresponding power, and operate strictly according to the operating procedures that stipulated in user's manual.

Do not connect the output terminal of soft starter with the capacitor, otherwise the soft starter will be damaged.

After the SJR2 is installed, please wrap the copper wire terminal that on the input and output terminal by insulating tape.

When it is remote control, please lock the key control.

Please make sure that the enclosure of soft starter is firmly earthed.

When maintain the equipment, please cut off the lead-in power supply first.

Although this manual is compiled carefully, but we cannot guarantee that it is absolutely correct. The technology and operating method of the products in this manual may be modified at any moment, so we cannot take it as a standard when sign a contract.

Catalogue

1. Concernment before operating	1
1-1 Inspection of incoming goods, 1-2 Product appearance.....	1
2. Installation and wiring	2-8
2-1 Operating environment, 2-2 Installing method.....	2
2-3 Wiring.....	3
2-4 Wiring of main circuit and earth terminal.....	4
2-5 Wiring diagram of main circuit of the soft starter.....	5
2-6 Wiring of control terminals.....	6
2-7 Layout diagram of control terminals.....	7
2-8 Diagram of primary and secondary wiring.....	8
3. Operation	9
3-1 Inspection and preparation before operating, 3-2 Operation method.....	9
4. Keyboard panel	10
5. Basic functions	11
6. Instruction for function selection	12
6-1 Display mode.....	12
6-2 Control mode.....	12
6-3 Operating time of output relay.....	12
6-4 Set the automatic restart function.....	12
7. Operating procedures	13
8. Help information	14
9. Protection function	14-16
9-1 Instruction of protection function.....	14
9-2 Setting of protection function.....	15
9-3 Protective tripping curve.....	16
10. Protection performance	17
11. Fault diagnosis	18
12. Starting mode	19-21
12-1 Current-limit starting mode, 12-2 Voltage ramp starting mode.....	19
12-3 Kick start, 12-4 Current ramp starting mode.....	20
12-5 Voltage and current-limit double closed loop starting, 12-6 Soft stop, 12-7 Free stop..	21
13. Outline size	22-23
14. Application range	24
15. RS485 communication	24
16. Optional table of peripheral equipments	25
17. Appendix	26

1. Concernment before operating

1-1 Inspection of incoming goods

After receiving the goods, please open the box to check the following items to see if there is any problem on the products, if there is, or it is not your ordered specification, please contact with the agent or the Shanyu office nearby.

① To check the specification that on the nameplate of soft starter.

Nameplate

SHSY	
NAME	SOFTSTARTER
TYPE	SJR2 017
POWEY	17 KW
VOLTAQE	AC380V50HZ
RATED CURRENT	35 A
SER.NO	
SHANGHAI SANYU ELECTRONICS EQUIPMENT CO., LTD	

Model of soft starter

S JR 2 017-3-G

G mens the integrated type, without G menans the standard type

Rated voltage: 3 → 380V

Standard motor capacity: 017 → 17KW

Serial No. 055 → 55KW

AC soft starter

Enterprise code of Shanyu company

② Check the appearance to see if there is any damage that caused by transportation, such as the outside cover and machine case. Also inspect the parts to see if there is any damage or loose phenomenon.

③ Besides the soft starter, there is a copy of operating manual.

④ When carry the soft starter, please carry the machine body but not control box of circuit board, otherwise, there may be falling injury or bodily injury.

1-2 Product appearance

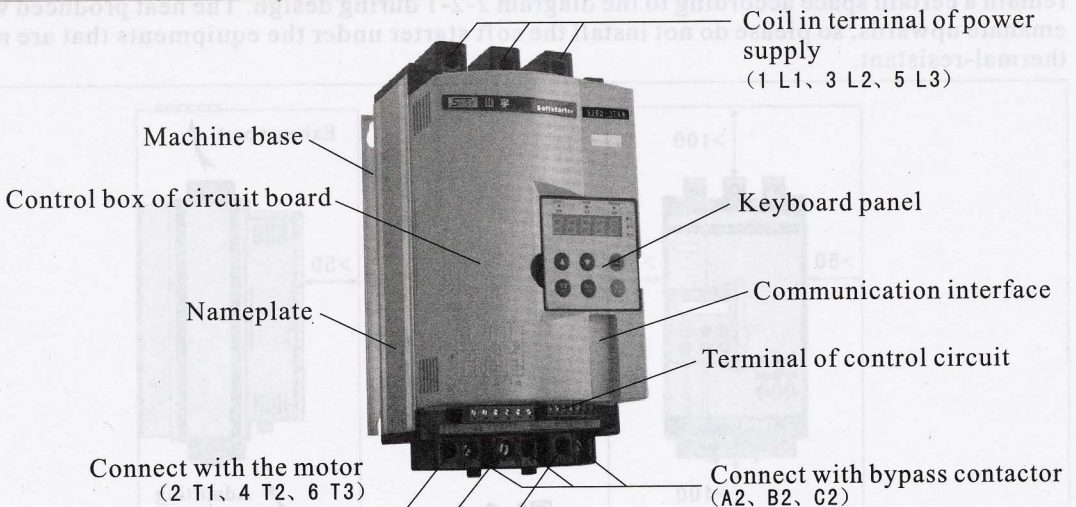

2. Installation and wiring

2-1 Operating environment

Table 2-1-1 indicates the requirements for operating environment
Table 2-1-1

Standard:		SJR2 develops the electronic soft start-soft stop device and has passed the performance test, complies with national standard: (GB14048.6-98)
Three-phase supply voltage (U)	V	380-15%...415+10% 440-15%...500+10%
Frequency	Hz	50
Suitable motor		Squirrel cage type three-phase asynchronous motor
Starting frequency		Please do not exceed 20 times per hour.
Degree of protection		Ip40 (Negotiable)
Resistance to impact		15g 11ms
Shock resistant capability		Altitude below 3000m, the vibratory force device below 0.5G.
Ambient temperature Working temperature Storage temperature	°C	0...+40 no capacity-fall (+40~60°C, rise every 1°C, the current will step down 1.2%) 25...+70
Ambient humidity		95% no condensation or drip
Max working height	M	No capacity-fall when lower than 1000m (when higher than 1000m, add every 100m, the current will step down 0.5%)
Cooling system		Cooled by natural wind.
Max operating angle relative to the vertical installing position		No requirement.

2-2 Installing method

- ① The soft starter should be installed vertically, never install it in inversion, gradient or level. Make use of screw to install it in a firm structure.
- ② When the soft starter runs, it will produce heat, in order to get enough cooling air, please remain a certain space according to the diagram 2-2-1 during design. The heat produced will emanate upwards, so please do not install the soft starter under the equipments that are not thermal-resistant.

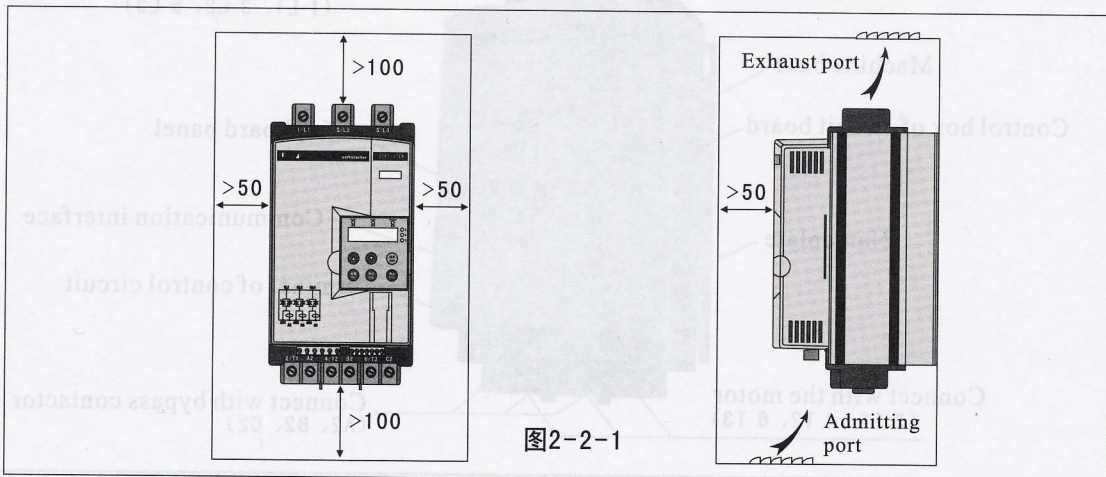

2. Installation and wiring

2-3 Wiring

Please pay attention to the following points when wiring. Refer to diagram 2-3-1 for basic wiring

- ① The power supply must be connected with terminals 1L1, 3L2 and 5L3 of main circuit, no phase requirement. If there is any wrong connection, it will damage the soft starter.
- ② The ground terminals must be earthed finely, so that it can avoid electric shock or fire accident, and it can reduce the noise.
- ③ The two terminals of lead should be compressed joint to assure high reliability in connection.

Diagram 2-3-1

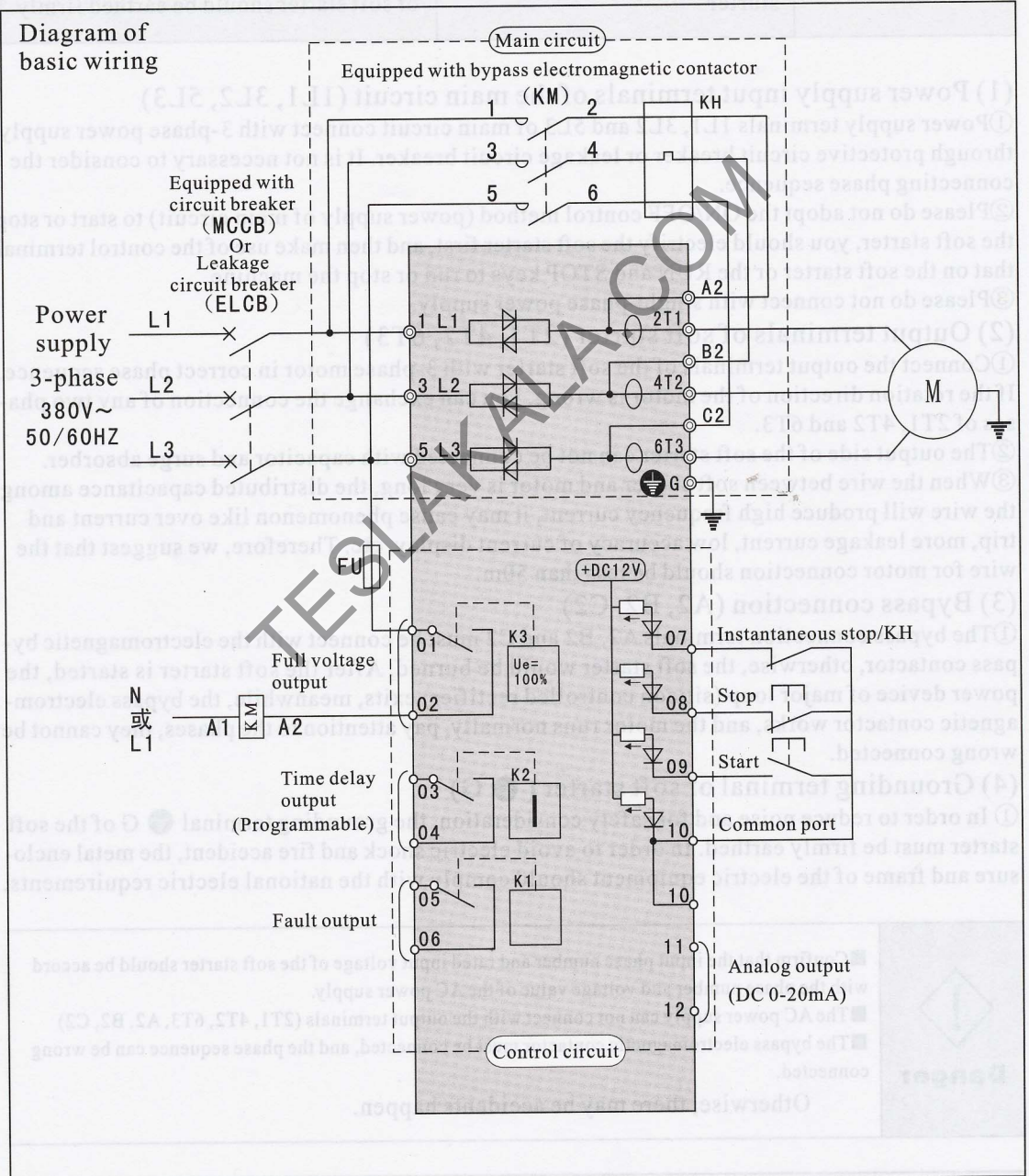

2. Installation and wiring

2-4 Wiring of main circuit and earth terminal

Table 2-4-1 Function of main circuit and earth terminal

Terminal mark	Terminal name	Description
1L1, 3L2, 5L3	Power supply input of main circuit	Connect with 3-phase power supply
2T1, 4T2, 6T3	Output connection of soft starter	Connect with 3-phase motor
A2, B2, C2	Bypass connection	Connect with bypass electromagnetic contactor
 G	Grounding terminal of soft starter	The grounding terminal of the case of soft starter should be earthed firmly

(1) Power supply input terminals of the main circuit (1L1, 3L2, 5L3)

- ① Power supply terminals 1L1, 3L2 and 5L3 of main circuit connect with 3-phase power supply through protective circuit breaker or leakage circuit breaker. It is not necessary to consider the connecting phase sequence.
- ② Please do not adopt the ON/OFF control method (power supply of main circuit) to start or stop the soft starter, you should electrify the soft starter first, and then make use of the control terminal that on the soft starter or the RUN and STOP keys to run or stop the machine.
- ③ Please do not connect with single-phase power supply.

(2) Output terminals of soft starter (2T1, 4T2, 6T3)

- ① Connect the output terminals of the soft starter with 3-phase motor in correct phase sequence. If the rotation direction of the motor is wrong, you can exchange the connection of any two phases of 2T1, 4T2 and 6T3.
- ② The output side of the soft starter can not be connected with capacitor and surge absorber.
- ③ When the wire between soft starter and motor is very long, the distributed capacitance among the wire will produce high frequency current, it may cause phenomenon like over current and trip, more leakage current, low accuracy of current display, etc. Therefore, we suggest that the wire for motor connection should be less than 50m.

(3) Bypass connection (A2, B2, C2)

- ① The bypass connection terminals A2, B2 and C2 must be connect with the electromagnetic bypass contactor, otherwise, the soft starter would be burned. After the soft starter is started, the power device of major loop (silicon controlled rectifier) exits, meanwhile, the bypass electromagnetic contactor works, and the motor runs normally, pay attention to the phases, they cannot be wrong connected.

(4) Grounding terminal of soft starter (G)

- ① In order to reduce noise and for safety consideration, the grounding terminal  G of the soft starter must be firmly earthed. In order to avoid electric shock and fire accident, the metal enclosure and frame of the electric equipment should comply with the national electric requirements.



Danger

- Confirm that the input phase number and rated input voltage of the soft starter should be accord with the phase number and voltage value of the AC power supply.
- The AC power supply can not connect with the output terminals (2T1, 4T2, 6T3, A2, B2, C2)
- The bypass electromagnetic contactor must be connected, and the phase sequence can be wrong connected.

Otherwise, there may be accidents happen.

2. Installation and wiring

2-5 Wiring diagram of main circuit of the Shanyu SJR2 soft starter

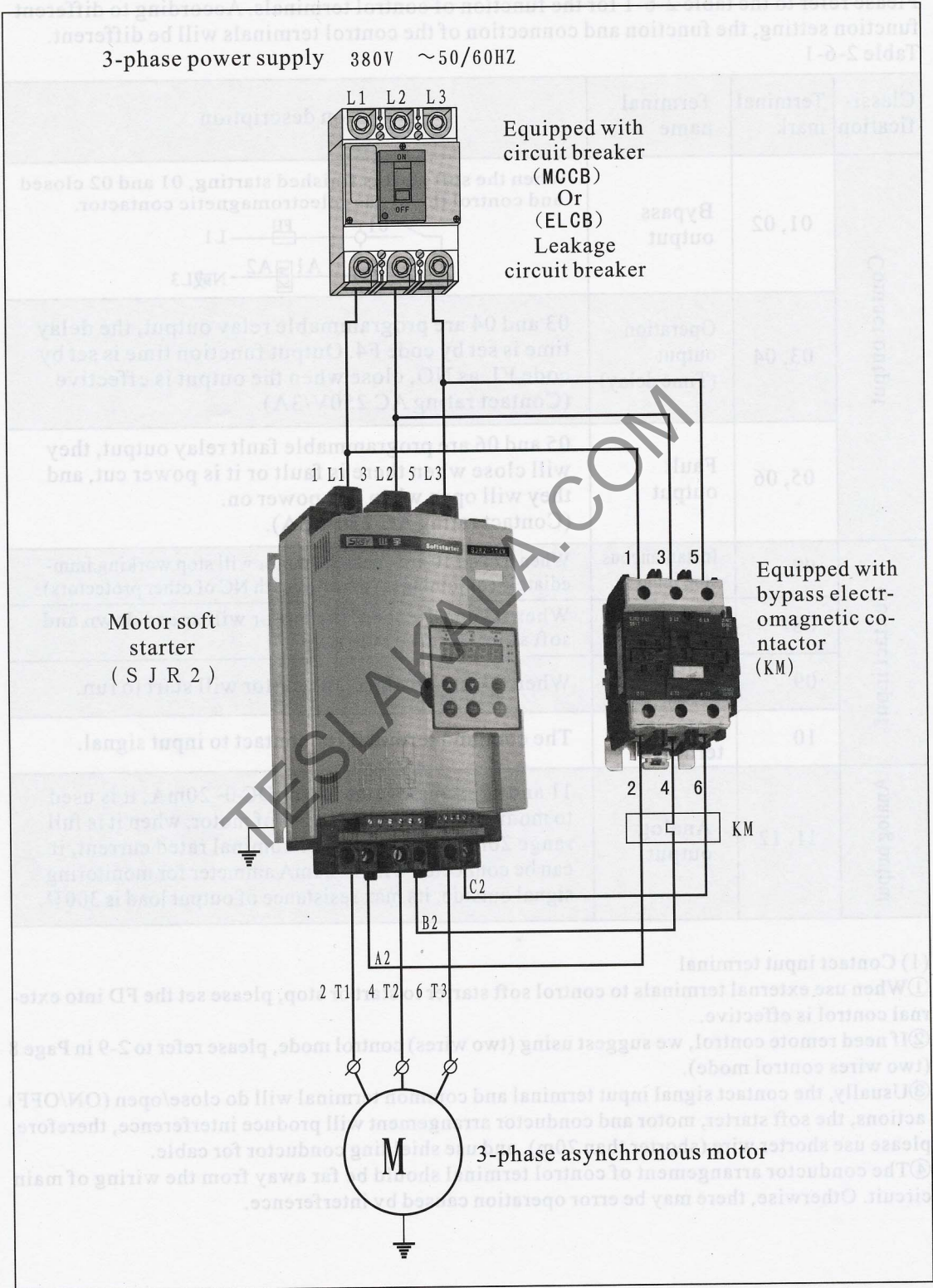

2. Installation and wiring

2-6 Wiring of control terminals

Please refer to the table 2-6-1 for the function of control terminals. According to different function setting, the function and connection of the control terminals will be different.

Table 2-6-1

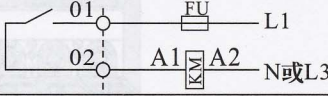
Classification	Terminal mark	Terminal name	Function description
Contact output	01, 02	Bypass output	When the soft start is finished starting, 01 and 02 closed and control the bypass electromagnetic contactor. 
	03, 04	Operation output (Time delay)	03 and 04 are programmable relay output, the delay time is set by code F4. Output function time is set by code FJ, as NO, close when the output is effective. (Contact rating AC 250V/3A).
	05, 06	Fault output	05 and 06 are programmable fault relay output, they will close when there is fault or it is power cut, and they will open when it is power on. (Contact rating AC 250V/3A).
Contact input	07	Instantaneous stop input	When 07 and 10 are open, the motor will stop working immediately (or joining up in series with NC of other protectors).
	08	Soft stop input	When 08 and 10 open, the motor will speed down and soft stop. (Or free stop)
	09	Starting input	When 09 and 10 close, the motor will start to run.
	10	Common terminal	The common terminal for contact to input signal.
Analog output	11, 12	Analog output	11 and 12 is analog output for DC 0~20mA, it is used to monitor the running current of motor, when it is full range 20mA, it is 4 times of nominal rated current, it can be connected with 0~20mA ammeter for monitoring signal outside, its max resistance of output load is 300Ω.

(1) Contact input terminal

- ① When use external terminals to control soft starter to start or stop, please set the FD into external control is effective.
- ② If need remote control, we suggest using (two wires) control mode, please refer to 2-9 in Page 8 (two wires control mode).
- ③ Usually, the contact signal input terminal and common terminal will do close/open (ON/OFF) actions, the soft starter, motor and conductor arrangement will produce interference, therefore, please use shorter wire (shorter than 20m), and use shielding conductor for cable.
- ④ The conductor arrangement of control terminal should be far away from the wiring of main circuit. Otherwise, there may be error operation caused by interference.

2. Installation and wiring

2-7 Layout diagram of control terminals

(1) Terminals of main circuit

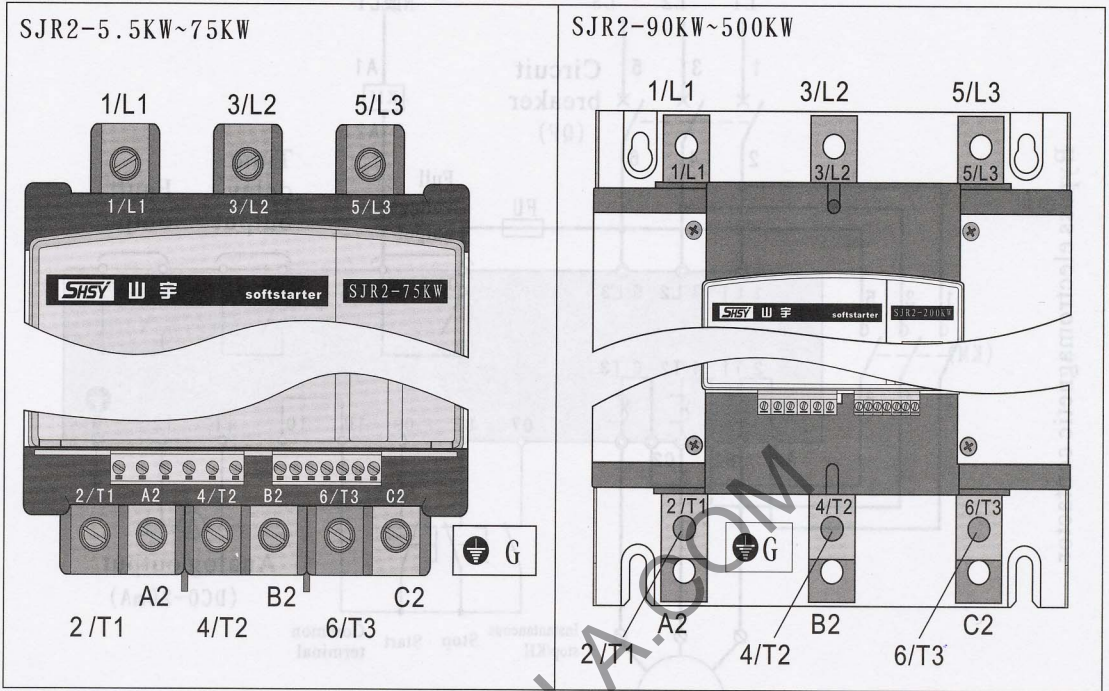

(2) Terminals of control circuit

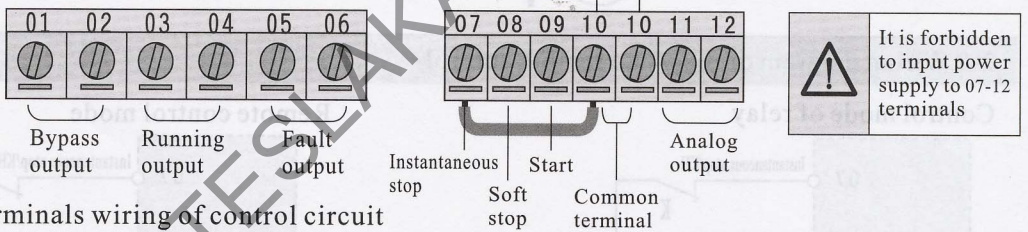

(3) Terminals wiring of control circuit

Three-wires control mode

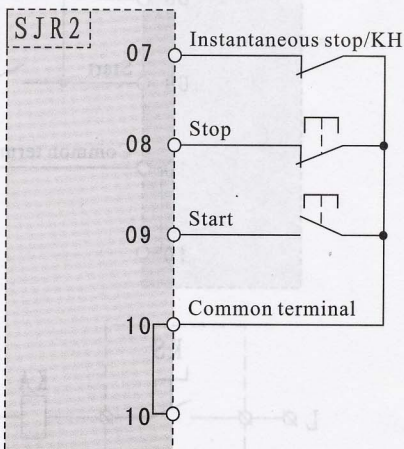

Two-wire control mode

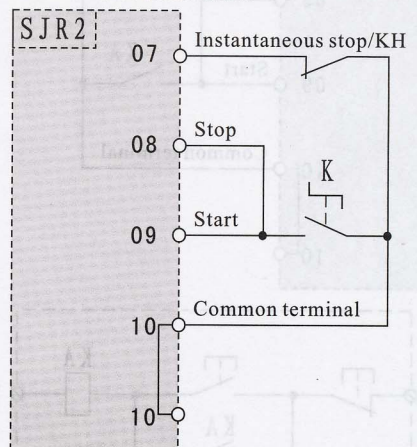

Wire for control terminal 0.75~1.25mm²

When K closes, it will start running, when it open, it will stop running

2. Installation and wiring

2-8 Diagram of primary and secondary wiring of Shanyu SJR2

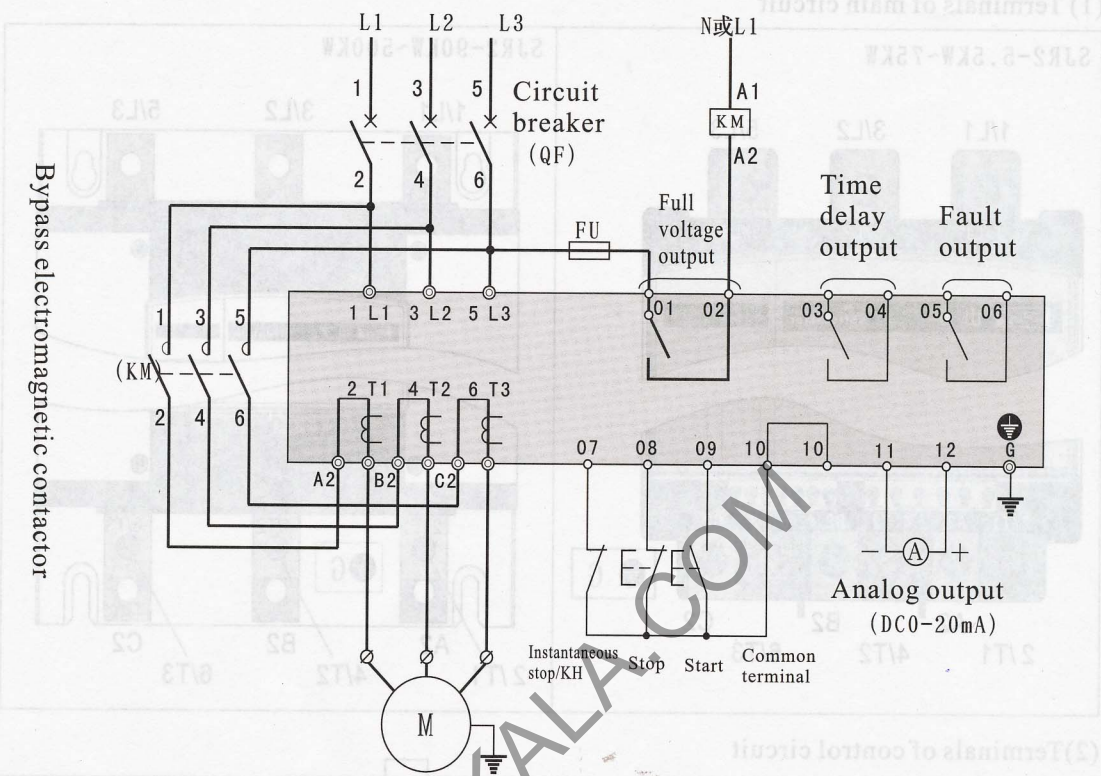

2-9 Wiring diagram of relay and remote control

Control mode of relay

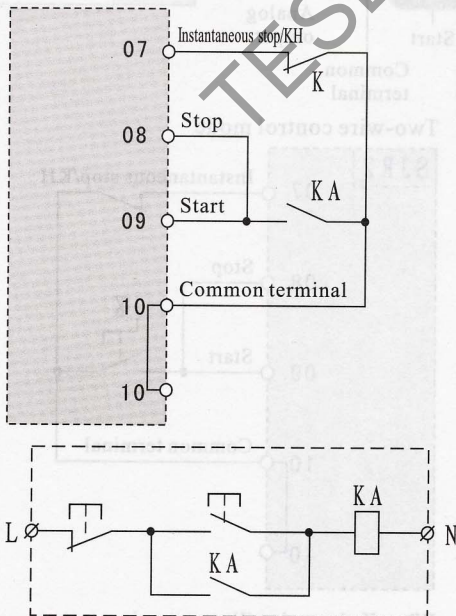

Remote control mode

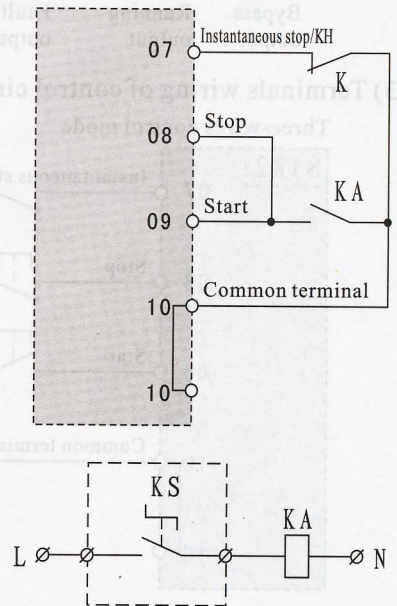

K is the NC point for other protectors (such as thermal protector), it is short-connection when leave the factory.

3. Operation

3-1 Inspection and preparation before operating

Before operating, please check the following points.

- ① Check if the wiring is right (especially the output terminals can not connect with power supply), if the bypass contactor is firmly connected, and if the grounding terminal is earthed in fine condition.
- ② Please confirm that there is not short-circuit or shortened to earth phenomenon among terminals and naked electriferous parts.
- ③ After the power supply is turn on, the keyboard will display **S.A.N.Y.U** (SANYU) or readiness **R.E.A.D.Y** and meanwhile, the ready indication lamp brightens.

See diagram 3-1-1.

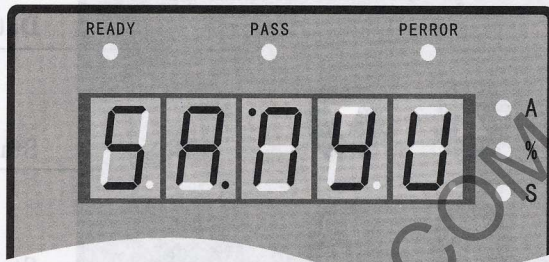

Diagram 3-1-1

3-2 Operation method

Choose the most suitable operation method according to the application requirements.

- After confirm that there is no abnormal phenomenon, then you can trial run the machine. When the product leaves the factory, it is set into keyboard operation mode.
- Press FP to set the rated power current on the nameplate of motor.
- Press “**起 动** RUN” key to start the machine and “**停 止** STOP” key to stop it.
- To see if the rotation direction of motor accord with the requirements.
- If the motor starting action is not satisfactory, you can adjust the set basic function in Page 11.
- If the starting torque of the motor is not enough, you can improve it through changing the starting voltage F0 (this way is effective when it is voltage mode) or cut-off current F6 (this way is effective when it is current mode).
- To see if the motor rotates stably (No whistler sound and vibration).
If there isn't any abnormal phenomenon, then you can put it into formal operation.

Notice:

- 1. If the running of soft starter and motor is abnormal, or it displays fault code **E.E.E.E**, please stop the machine immediately, and find out the cause according to “fault diagnosis” in P18.
- 2. When the site temperature is lower than 10C, please electrified and preheat for more than 30 minutes and then start the machine.

4. Keyboard panel

4-1 Appearance of the keyboard

The keyboard has plenty of operating functions, such as functional data of confirmation and changing for keyboard running and stopping, and various status confirmation, etc.

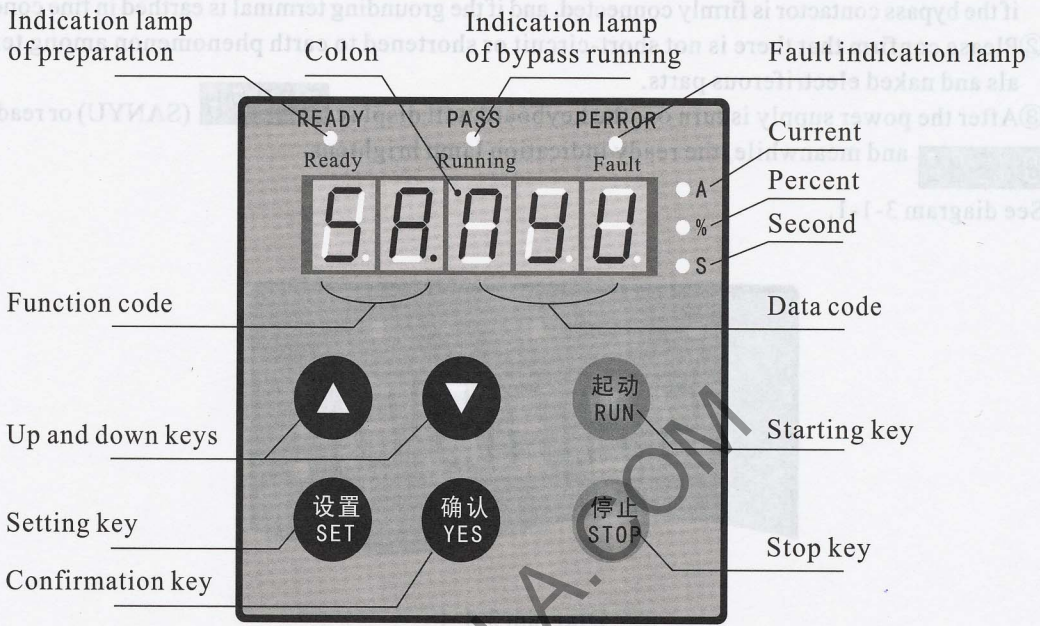

Table 4-1-1 Functions of the operating keys

Key name	Main functions
Starting key	When display , press this key, it starts, and meanwhile displays starting state .
Stop key	1. When it is normal running, it displays (current value) and the bypass indication lamp lightens, press this key can stop the machine. When the machine is fully stopped, it will display . 2. This key has reset function.
Setting key	It displays press this key and enter into the menu setting, when it displays , press it again. The colon flashes, at this moment, you can press “Up” and “DOWN” keys to modify the parameter.
Confirmation key	1. When finishing the modifying work, press this key to keep the parameter, display and give sounds for two times, it means the data has been stored, press this key again or the stop key to exit. 2. Press this key and it displays the input supply voltage , refer to table 8-1 in Page14 for details 3. Press this key and power on at the same time to reset the parameter back to the factory value.
Up and down keys	1. Enter into the menu setting, press this key to modify the parameter, (when the colon doesn't flash , press the key to modify the function code. When the colon flashes , press the key to modify the data code). 2. During running, press this key to observe the current A, power P and overload thermal equilibrium.

- When the data is larger than 999, the last radix point will be brighten, it means add 0 to mantissa.
- When press a key, there has sound given from the inner soft starter, if no, it means it is inefficient to press this key.
- The keyboard can be taken off, (when operate outside the cabinet) the length of the lead should be less than 3m.

5. Basic functions

5-1 Function of code setting

Function code	Name of function	Setting range	Factory value	Description
F0.888	Starting voltage	30-70%	F0.880	Effective under voltage ramp mode; when FB is set at 1, it is modifiable, and set at 0, the starting voltage is 40%
F1.888	Time of soft start	2-60S	F1.886	Effective under voltage ramp mode; when code FB is set 1, the modification is effective
F2.888	Time of soft stop	0-60S	F2.804	When it is set at 0, it is free stop, N-in-one set at 0
F3.888	Time delay starting	0-999S	F3.800	Press starting key (set the time), time delay starting by count down, set at 0, it will start immediately
F4.888	Time delay programming	0-999S	F4.800	Output (03 and 04 terminals) of the relay, set at 0, it will close immediately
F5.888	Time delay interval	0-999S	F5.800	Time delay when release from overheat, the indication lamp flashes during the time delay
F6.888	Current limiting when starting	50-500%	F6.400	Effective under current limiting mode; when code FB is set at 0, the modification is effective, and set at 1, the max current limiting value 400%
F7.888	Max working current	50-200%	F7.100	The input mode of parameter F6 and F7 is determined by F8
F8.888	Display mode of the keyboard	00-03	F8.804	Refer to 6-1 in Page 12 for details
F9.888	Under-voltage protection	60-90%	F9.880	Protect when it is lower than the set value
FA.888	Over voltage protection	100-130%	FA.120	Protect when it is higher than the ser value
FB.888	Starting mode	00-05	FB.804	00 current-limit; 01 voltage; 02 kick +current-limit; 03 kick +voltage; 04 current ramp; 05 double closed loop
FC.888	Allowed output protection	00-04	FC.802	00 primary; 01 light load; 02 standard; 03 heavy load; 04 senior
FD.888	Operating control mode	00-07	FD.800	When set at 0, it is keyboard operation, refer to 6-2 in Page 12 fore details
FE.888	Allowed restart	00-09	FE.800	0: forbidden; 01-09: times of automatic restart
FF.888	Allowed parameter modify	00-01	FF.804	00: not allowed to modify the parameter; 01: allowed to modify the parameter
FH.888	Communication address	00-64	FH.800	Used for multi soft starters and upper machine for multi-machine communication
FI.888	Programming output	00-07	FI.800	Output setting (03 and 04 terminals) of relay, refer to 6-3 in Page 12
FL.888	Current limiting when soft stop	0-1	FL.800	Refer to description in P21
FP.888	Motor power	5-500KW	FP.485	This soft starter serves for the motors below 18.5KW

- Remark:
1. The max working current whose code is F7 means the max current for motor's continuous operation on the basis of FP setting value.
 2. If you do not press the operating keys when under the setting state, then it will exit the setting state automatically.
 3. It is unable to set any parameter during soft start and soft stop, and you can set under any other state.

6. Instruction for function selection

6-1 Code F8 is used to choose input mode and display mode

The set value of code F8	0	1	2	3
Input mode of F6 and F7	Current value	Percent	Current value	Percent
Display mode	Current value	Current value	Percent	Percent

■ When code F6 and F7 input by percent, it indicates the percent of current value of the motor set by code FP.

6-2 Code FD is used to choose control mode of the soft starter

Value of FD	0	1	2	3	4	5	6	7
Keyboard control	✓	✓	—	—	✓	✓	—	—
Terminal control	—	✓	✓	✓	✓	—	—	—
Communication	—	—	—	✓	✓	✓	✓	—

■ ✓ means can be chosen, and — means can not. If you want no unexpected stop after starting or no unexpected starting during maintenance, then you can set the FD at 7, and it will forbid any starting or stop operation.

■ When it is allowed external control, please connect with a NC button switch or short circuit between the external control terminals 08 and 10, so that when it is open circuit, it can not start the motor.

6-3 FJ is used to set the operating time of output relay

Value of FJ	0	1	2	3	4	5	6	7
Operating time of output relay	When send the starting order	When starting	When bypass running	When stop	When finished stopping	When instantaneous stop	When there is fault	When the auto restart is finished

■ When the F4 is not 0, then take the above time as starting point and begins time delay according to set time of F4. When time delay finishes, it acts, when F4 is 0, it will act immediately.

■ The output reset time (namely contact break) that is after F4 set time finishing delay, then retain 1s; if start motor again, it breaks off last programming automatically, while, starting the cause. It can program the relay output function flexibly, shorten the external control logic circuit efficiently.

6-4 Start functional setting automatically

■ FE is not 0, please permit to restart function automatically. This function is only for external control two-wire mode, it is not controlled by FD. It is set at closing and starting according to the connection of two-wire mode.

■ It delays for 60s when power is on, then it will start again automatically.

■ F5 set time is more than 60s, please delay though pressing F5 set time. The indication lamp flashes at delaying state.

■ It can start for “n” times, besides starting when power is on and restarting after occurring the fault, “n” is the FE set value.

■ Automatic restarting doesn't effect until it is started, it still effects if switch on every time.



Warn



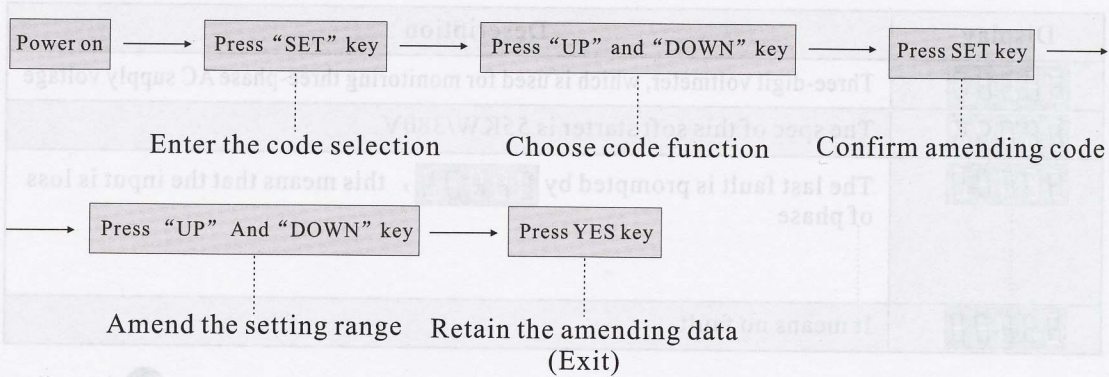

This soft starter possesses the loss-voltage protection function, it says that the power is off but power is on later, wherever the external terminal is, it can't start automatically, in order to prevent the injuring accident. When automatic restarting is permitted, the power failure protection is unavailable.

7-1 Operating procedures

7-1 Amend the setting parameter







Take the example of amending (Operating control code, external terminal control, FD is set for 2).



Code	Operate	Display	Description
1	Power on	58840	SANSU or 2E884 ready state
2	Press SET key 	FD:000	Enter the state of function code selection
3	Press Up key for 13 times 	FD:000	Enter the state of FD function code selection (Operate control mode)
4	Press SET key 	FD:000	Flash the colon, it means that the setting range may be amended.
5	Press UP key for 2 times 	FD:002	It says that the external terminal control
6	Press "YES" key 	89.000	The amending data has been retained. (Exit) 2E884

When operate the key, the inner buzzer in the soft starter sends the sound for prompting.

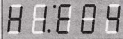
8-1 Help information

8-1 Help information

Display	Description
	Three-digit voltmeter, which is used for monitoring three-phase AC supply voltage
	The spec of this soft starter is 55KW/380V
	The last fault is prompted by  , this means that the input is loss of phase
	It means no fault

It can enter the help information under no soft start/soft stop, please press  key, then press  or  key to refer the prompt information.

9 Protection function

9-1 Instruction of protection function

SJR2 series has perfect protection function, in order to safe to use. During using, please set the protection grade and protection parameter properly according to different situations.

- Over-heat protection: When the temperature rises at $80^{\circ}\text{C} \pm 5^{\circ}\text{C}$, it causes the protection action, when the temperature falls at 55°C (min), the over-heat protection is removed.
- The lag time of input open-phase protection: Less than 3s.
- The lag time of output open-phase protection: Less than 3s.
- The lag time of three-phase unbalance protection: Less than 3s. Base on the declination of each-phase current more than 50%, when the load current is lower than 30% of nominal rated value of soft starter, the reference declination decided is increased.
- Time of over-current protection at starting: The time of protection that when the duration is more than 5 times of F7 max working current is shown in P15:19-2-1 table.
- Time of over-load protection at running: Basing on the F7 max working current, it runs the inverse time lag protection, the curve of protection is shown in P16:9-3-1.
- Lag time of over-low protection of supply voltage: When the supply voltage is lower than 40% of the limited value, the protection action time is less than 0.5s, otherwise, this protection action would be less than 3s when it is less than this value.
- Lag time of over-high protection of supply voltage: When the supply voltage is higher than 130%, the protection time is less than 0.5s, otherwise, it is higher than this value, the protection time is less than 3s.
- Lag time of load short-circuit protection: Less than 0.1s, the current is more than 10 times of nominal rated current of soft starter.
- Above parameter that is from detecting the effective signal to send the release protection order, the parameter is only for reference.

In case that the protection function of soft starter doesn't meet the user's requirement, please add special protection equipment.

9 Protection function

9-2 Setting of protection function

Cater for different occasions, SJR2 series soft starter has set five protection grades, they are 0 junior, 1 light load, 2 standard, 3 heavy load, 4 senior, all of them are set by FC.

- The junior protection has prohibited the external instantaneous stop function, while, only retaining over-heat protection, short-circuit protection and input open-phase protection at starting, it is used for the occasion that doesn't need any condition to start the emergent starting.
- Light load protection, standard protection and heavy load protection posses complete protection function, they are distinguished by the curve of overload heat protection time of motor. The parameter of heat protection time of motor is shown in the table 9-2-1 and diagram 9-3-1.
- The protection standard at starting for senior protection is stricter, other protection function parameter is the same with that of standard protection.

Different protection grade and heat-protection time set by FC is shown in table 9-2-1

Table 9-2-1

FC set		0 Junior	1 Light load	2 Standard	3 Heavy load	4 Senior	Description
Operating overload Protection grade		No	2 grade	10 grade	20grade	10 grade	As per IEC60947-4-2 standard
Starting current Protection time		No	3s	15s	30s	15s	Calculated according to the starting current over 5 times set by F7
Releasing time of running overload	Current times (I/Ie)	3 4 5	3 4 5	3 4 5	3 4 5	3 4 5	The value in table is the topical value.
	Releasing time (s)	4.5 2.3 1.5	23 12 7.5	46 23 15	4.5 2.3 1.5	23 12 7.5	

- Set the FP, otherwise according to the rated current value on the motor nameplate, when F6, F7 input mode are the percentage mode (Set by F8), the starting current and protecting current would have the large difference.
- The motor current set by FP can't be lower than 20% of nominal current of soft starter, when the motor current set by FP is smaller, the error of sensitivity of protection release is increased.

9 Protection function

9-3 Protective tripping curve.

The curve for release protection of motor as per IEC60947-4-2 standard

Diagram 9-3-1

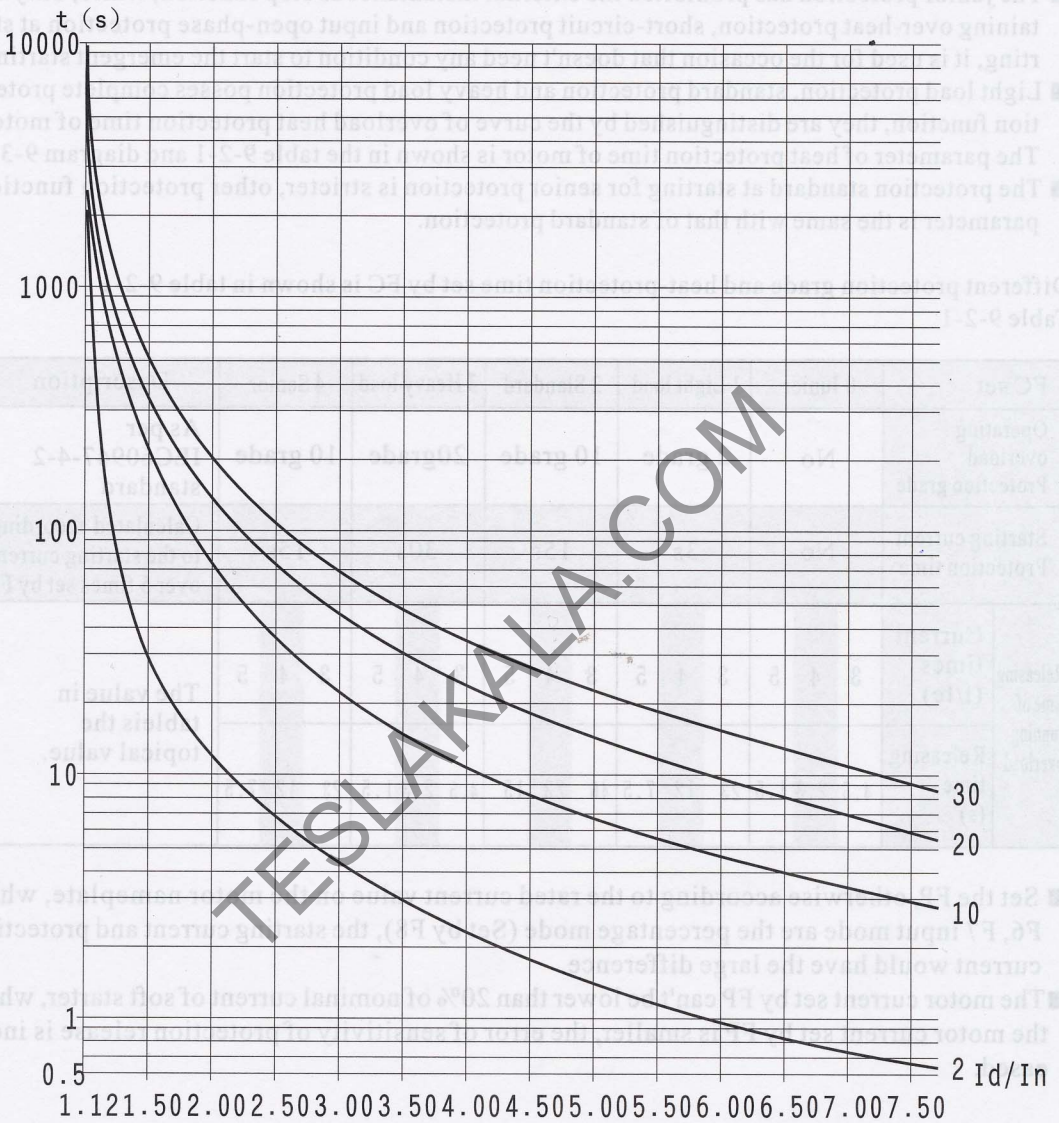

Curve for thermal protection of motor (State)

10. Protection operation

10-1 The list for protection operation

When the soft starter occurs abnormality, the protection function runs, it trips immediately, LED displays alarming name and concerned content, please refer to table 10-1-1.

Table 10-1-1

Panel display	Alarming name	Operation content and treatment
	The fault has been removed	The faults like over-voltage, under-voltage, or overheat, instantaneous stop terminal opening circuit has been removed, then, turn on the lamp, press "YES" key to start the motor.
	External instantaneous-stop terminal opens circuit	Check if 07 and 10 terminals are connected, and the NC contact are connected with other protective equipment or not.
	Soft starter is over heat	The starting is too frequently, or the power of motor isn't fitted with that of soft starter.
	Over long starting	The starting parameter is set improperly, or the load is too heavy, the power capacity is not enough.
	Input open-phase	Check the power for 3-phase, make sure that by-pass contactor isn't clamped in the closing position, the controllable silicon isn't short circuit, KG wire is connected well.
	Output open-phase	Examine output circuit and connecting wire of motor, make sure that by-pass contactor isn't clamped in the closing position, the controllable silicon isn't short circuit, KG wire is connected well.
	Three-phase unbalance	Check if input three-phase power and load motor are normal or not.
	Start over-current	Check if the load is too heavy or not, or the power of motor isn't fitted with that of soft starter.
	Run over-load protection	Check if the load is too heavy or not, or the F7 parameter is set wrong.
	Too low supply voltage	Check input supply voltage, or F9 parameter is set wrong.
	Too high supply voltage	Check input supply voltage, or FA parameter is set wrong.
	The set parameter is error	Amend the setting or press key to start and recover the factory value.
	Load short-circuit	Check the load or motor, and the controllable silicon is short circuit or load is too large.
	Automatic restart, the connection is error	Check the external control starting and stopping terminal is connected with 2-wire controlling mode.
	The connection of external stopping terminal is error	When the external control mode is permitted, the external control stopping terminal is in the open-circuit state, so it can't start the motor.

Some faults is related, for example, report that soft starter is over heat, starting over current or load short-circuit, therefore, when check the fault, please consider comprehensively, to judge the faults accurately.

Notice:

When soft starter starts motor successfully, the indication lamp for running in the middle of panel lightens, it says that the it runs at the bypass, if the bypass contactor can't absorb, it will cause the motor stops running, thus, you shall check the bypass contactor and connection.

11. Fault diagnosis

11-1 Problem and countermeasure

Abnormality	Content checked	Countermeasure
The motor can't run	The wiring Weather the power wire is connected to input the terminal or not. (1L1, 3L2, 5L3)	Please give the correct wiring Switch on power Cut off the power, then switch on
	Weather bypass contactor works or not, and 01, 02 terminal has no signal or not.	Check the connection situation of bypass contactor. Check the connection situation of coil of bypass contactor.
	Weather the keyboard is abnormal to display or not.	Please read P17 "Protection operation list"
	Weather the motor is locked or not, (Weather the load is too heavy or not).	Clear away the locking of motor (Reduce the load)
The keyboard can't start	Weather the keyboard has displayed or not. Weather 07, 10 terminals open circuit or not, FD setting is correct or not.	No: Weather the power opens phase or not, check the inlet power. Yes: 10 and 07, 08 open circuit, check external connection of terminal, please set the FD code correctly.
External control can't start	Weather FD is set at external controlling or not.	Terminal 10 and 07, 08 opens circuit, check the external connection of terminal, please set the FD code correctly, check if it is in the external control poison or not
Although the motor rotates, the speed is not changed.	Weather the load is too heavy or not.	Please reduce the load Add the initial voltage or starting current
The starting time is too long.	The load is too heavy, the code hasn't been set, weather the spec of motor is correct or not.	Please reduce the load Please set F0 (Initial voltage), F6 (Starting current), F1(Starting time) Please check the specification and nameplate
The starting time is short	The load is light The starting time is too short	When the load is light, the starting time is often less than setting value, the starting is normal, set the starting time of F1 (the current mode is unavailable).
It stops suddenly during running.	Check the external input terminal	Check connection of 07, 10 terminals fails or not. If the external protector is equipped with, please check NC contact operates or not Check the connection of external stop button fails or not.

12. Starting mode

12-1 Current-limit starting mode, 12-2 Voltage ramp starting mode

- ① It is the current starting mode when FB is set for 0 (0 limited current). The current various waveform of motor at limited current starting mode is shown in the diagram 12-1-1. Thereinto, I_1 is the starting current-limit required, when the motor starts, the output voltage increases rapidly, till the current of motor reaches the current-limit I_1 required, and the current of motor shall be not more than this value, then the motor speeds up step by step as the rising of output voltage, when the motor is up to the rated rotary speed, the bypass contactor absorbs, the output current falls down rapidly to rated current of motor I_e or below, up to now, the starting has been finished.
- ② When the load of motor is too light or the limited current set is too high, it is normal that the max current at starting is likely not to get the limited current set. Generally, the current-limit starting is used for the occasion that requires the starting current strictly.

Diagram 12-1-1

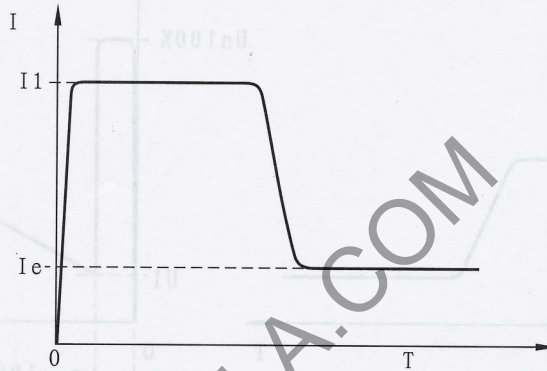

12-2 Ramp start of voltage

- ① It is the current starting mode when FB is set for 1 (1 limited current). The output voltage various waveform at voltage ramp starting is shown in the diagram 12-2-1. Thereinto, U_1 is the initial voltage at starting, when the motor starts, the current of motor can't be more than 400% of rated value, the output voltage of soft starter reaches U_1 rapidly, then, the output voltage rises generally according to the starting parameter, the motor speeds up stably as the voltage, when the voltage reaches rated voltage U_e , when the motor gets the rated rotary speed, the bypass contactor absorbs, thus, the starting has been finished.
- ② The starting time t is the control parameter got according to standard load under the standard experiment, SJR2 series soft starter takes this parameter as the reference, the motor can speed up stably with the help of control output voltage to finish the starting, it doesn't consider the motor rotation situation not due to mechanical control time. In term of this, when the load is light, the starting time is often less than the one set, only it can start smoothly, it belongs to normal. Generally speaking, the ramp start mode of voltage is applicable for start stability that is required strictly but the start current.

Diagram 12-2-1

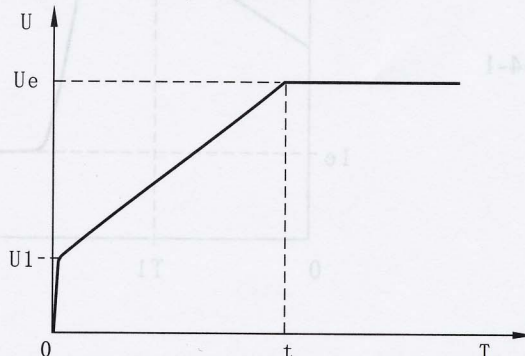

12. Starting mode

12-3 Kick start

- ①FB sets for 2 (Kick + limited current) or sets for 3 (Kick + voltage) starting mode, output variable waveform of kick starting mode is shown in diagram 12-3-1 and diagram 12-3-2. In some occasion with heavy load, if the motor can't be started due to mechanical static friction force, this starting mode can be chosen. Before starting, please apply high fixed voltage to motor and let it keep for limited time, in order to rotate the motor through overcoming the static friction force, then, make it start according to limited current or voltage lamp mode.
- ②Before using this mode, please start this motor with non kick mode, if the motor can't rotate for too large static friction force, then you can choose this mode; otherwise, please avoid this mode to start for reducing the unnecessary large current impact.

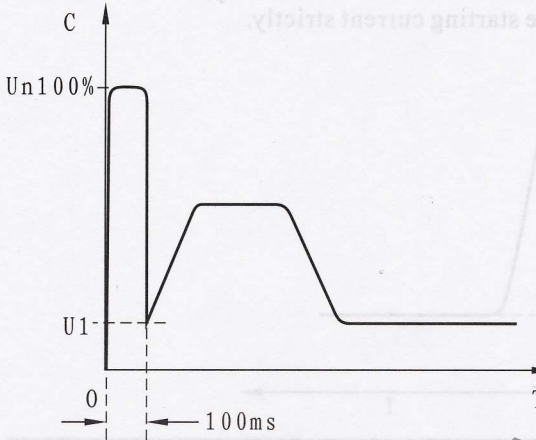

Diagram 12-3-1

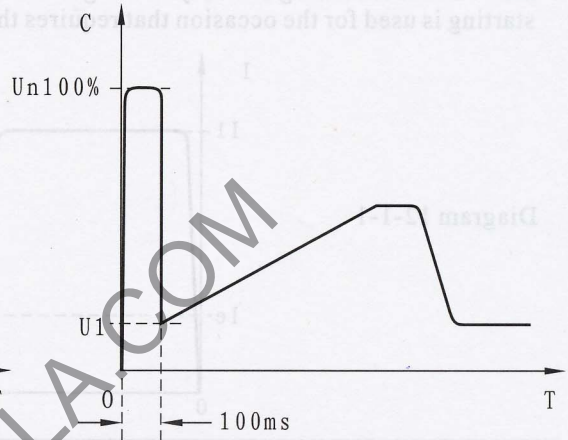

Diagram 12-3-2

12-4 Current ramp starting mode

- ①FB sets for 4 that is this starting mode. Diagram 8-1-3 is the output current waveform of current ramp starting mode. Thereinto, I_1 is the limited value set by F6, T_1 is the time set by F1.
- ②The current ramp starting mode has the strong acceleration ability, it is suitable for two-pole motor, also can shorten the starting time in the certain range.

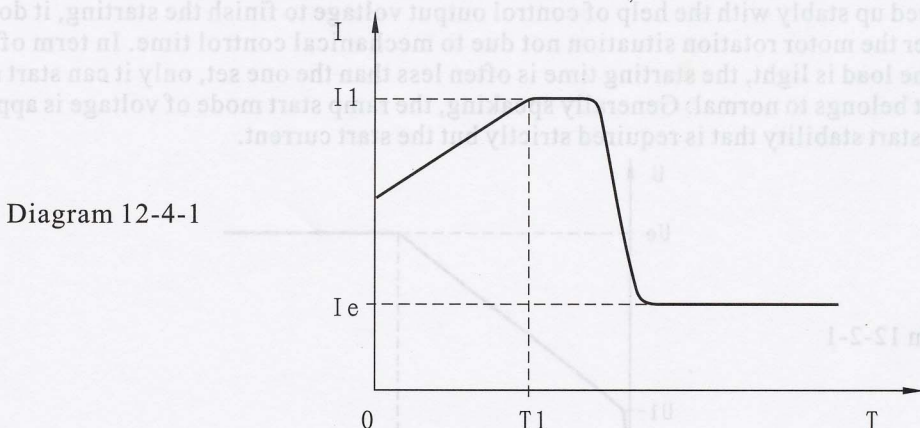

Diagram 12-4-1

12. Starting mode

12-5 Voltage and current-limit double closed loop starting

- ① When FB is 5 (Double closed loop), it is the double closed starting mode. This mode adopts voltage ramp and current-limit double closed loop to control, it is a comprehensive starting mode that requires stable starting and strict current-limit, and it adopts the pre-calculating method that evaluates the working state of motor.
- ② The output voltage waveform of this kind of starting mode will be different according to the motor and loading condition.

12-6 Soft stop

SJR2 series soft starter has two stop modes that is soft stop mode and free stop mode.

- ① When F2 is not 0, it is soft stop mode. Refer to diagram 12-6-1 for output current waveform of soft stop mod. TF is soft stop time set by F2. Under this stop mode, the power supply of motor can be got through bypass contactor switching into thyristor output of soft starter, the output voltage of the soft starter will be reduced gradually from full voltage, in this way, it reduces the rotary speed gradually without causing the vibration till the motor stops. The output cut-off voltage of soft stop is equal to the starting voltage.
- ② Soft stop mode can reduce or eliminate the load surge like water pump. Under soft stop mode, you can set soft stop current-limit value by FL to reduce the heavy current impact when reducing soft stop, this soft stop current-limit value is a percent that is calculated on the basis of starting current-limit.

Diagram 12-6-1

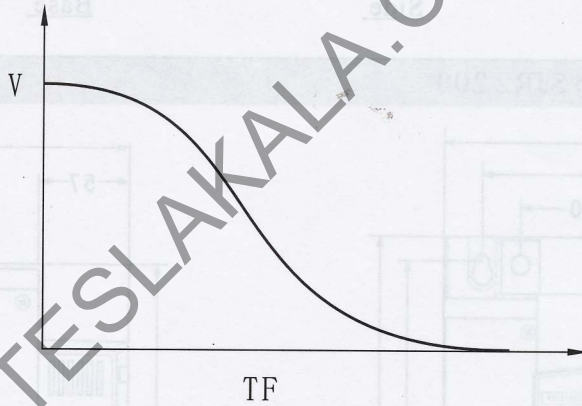

12-7 Free stop

- ① Set F2 at 0 (free stop), it is free stop mode. Under this stop mode, as soon as the soft starter receiving the stop order, it will switch off the bypass contactor immediately and forbid the voltage output from thyristor, and the motor will stop gradually as the load inertia. When the wiring method of the soft starter is in n-in-one, then you'd better set it into this mode to avoid loss-of phase fault report during output switching.
- ② Usually, you should choose the free stop mode if it is not necessary to choose the soft stop. Free stop will prolong the service life of soft starter. The free stop mode completely forbids instantaneous output, it avoids instantaneous heavy current impact in special application condition.

Sanyu SJR2 soft starter has six different starting modes, it is suitable for various complex motors and different bad conditions, and the users can choose according to their application ranges.

13. Outline size

13-1 SJR2 005 to SJR2 075

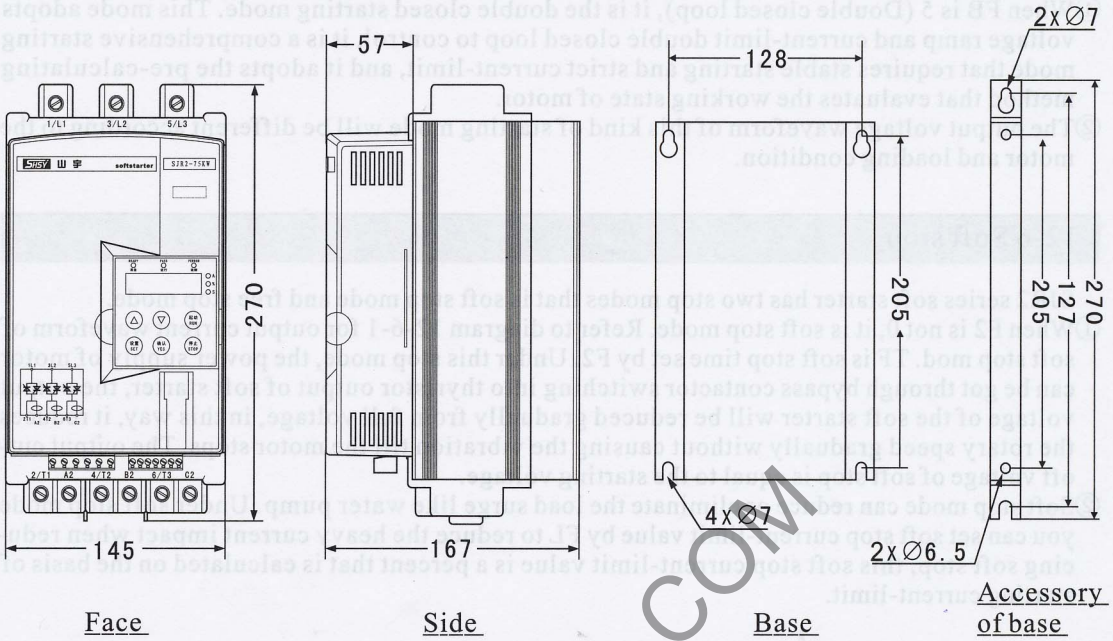

13-2 SJR2 090 to SJR2 200

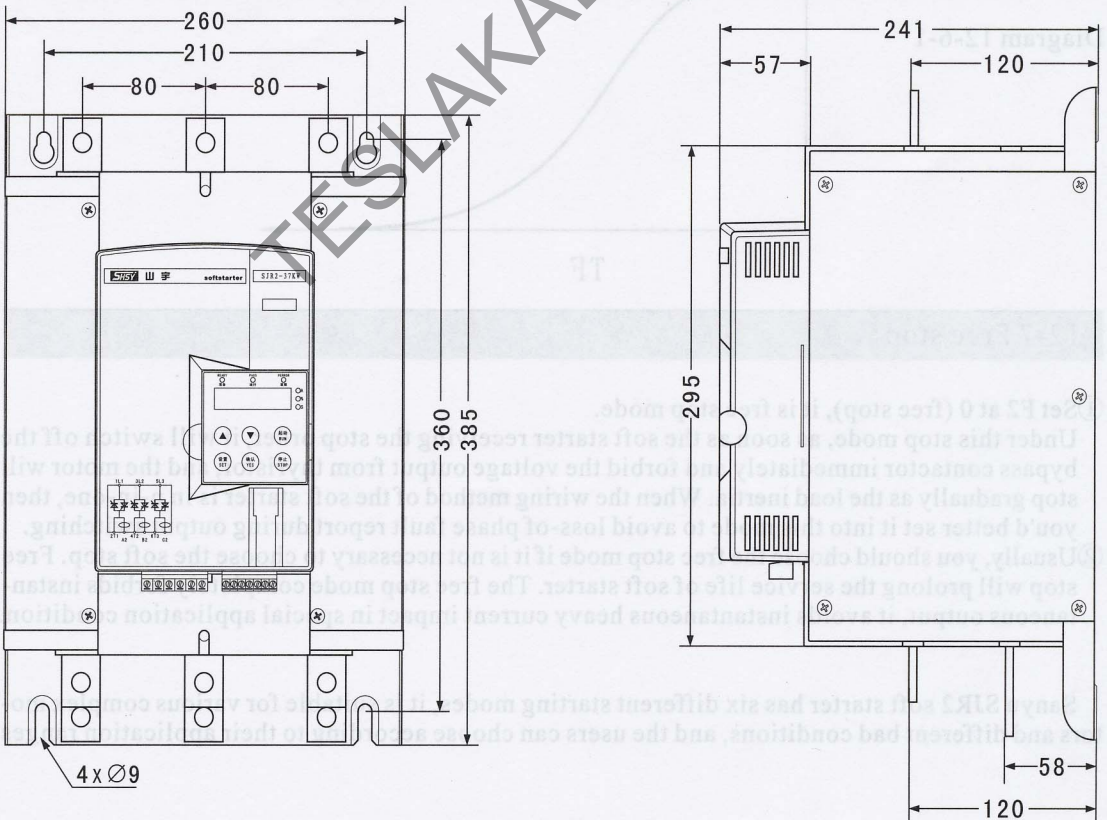

13. Outline size

13-3 SJR2 250 to SJR2 400(500)

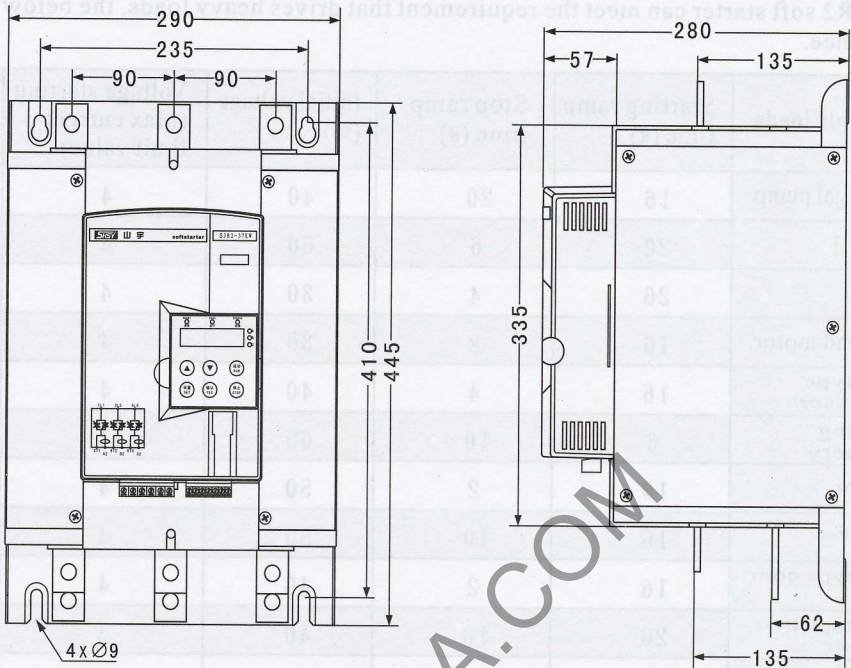

13-4 SJR2 7.5 to SJR2 75G



(MORE THEM 90KW IS GGD SHAPE)

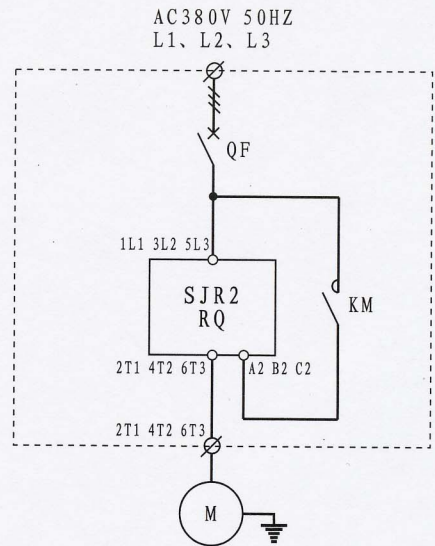

SJR2-G (main circuit inside)

14. Application range

14-1 Sort of application load

Sanyu SJR2 soft starter can meet the requirement that drives heavy loads, the below table is only for reference.

Applicable loads	Starting ramp time (s)	Stop ramp time (s)	Initial voltage (%)	Voltage starting (Max current-limit value)	Current-limit starting
Centrifugal pump	16	20	40	4	2.5
Ball mill	20	6	60	4	3.5
Fan	26	4	30	4	3.5
Light load motor	16	2	30	4	3
Piston type compressor	16	4	40	4	3
Elevating machinery	6	10	60	4	3.5
Agitator	16	2	50	4	3
Crusher	16	10	50	4	3.5
Spiral type compressor	16	2	40	4	3
Spiral type belt conveyer	20	10	40	4	2
Conveyer belt	20	10	40	4	2.5
Heat pump	16	20	40	4	3

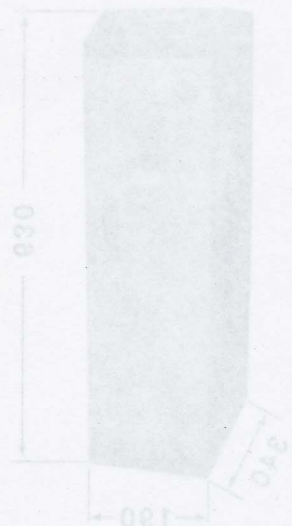
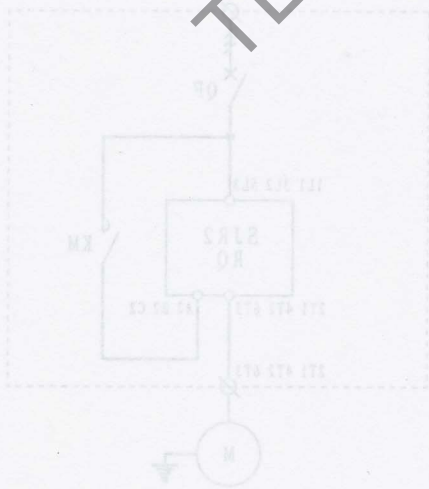

15. Optional table of peripheral equipments

15-1 Equipment fitted with SJR2 soft starter and the wire size

(Voltage: 380V)

Parameter of motor		Soft starter	Circuit breaker	Electromagnetic contactor	Cable/copper bar
Power (KW)	Current (A)	Model & Spec	Model & Spec	Model & Spec	Spec of copper core (mm ²)
5.5	11	SJR2 005	CM1-63/16	LC1 D12	2.5
7.5	15	SJR2 007	CM1-63/20	LC1 D18	4
11	21	SJR2 011	CM1-63/32	LC1 D25	6
15	28	SJR2 015	CM1-63/40	LC1 D32	10
18.5	34	SJR2 018	CM1-63/50	LC1 D38	10
22	42	SJR2 005	CM1-63/63	LC1 D50	16
30	54	SJR2 030	CM1-100/80	LC1 D65	25
37	68	SJR2 037	CM1-100/100	LC1 D80	35
45	80	SJR2 045	CM1-160/125	LC1 D115	35
55	98	SJR2 055	CM1-160/160	LC1 D115	35
75	128	SJR2 075	CM1-225/180	LC1 D150	50
90	160	SJR2 090	CM1-225/225	LC1 F180	30X3
115	190	SJR2 115	CM1-225/315	LC1 F225	30X3
132	236	SJR2 132	CM1-400/315	LC1 F265	30X3
160	290	SJR2 160	CM1-400/350	LC1 F320	30X5
200	367	SJR2 200	CM1-400/500	LC1 F400	30X5
250	430	SJR2 250	CM1-630/630	LC1 F500	40X5
280	470	SJR2 280	CM1-630/630	LC1 F500	40X5
320	547	SJR2 320	CM1-630/700	LC1 F630	40X5
400	725	SJR2 400	CM1-800/800	LC1 F800	40X8
500	1000	SJR2 500	CM1-1200/1200	LC1 F1200	40X10

Above equipments fitted are only for reference.

16. Appendix

About warranty period and after-sale service

Thank you for purchasing soft starter produced by Sanyu company, this product is manufactured under a perfect quality control system, but once there is any fault, please refer to the following points for the warranty period and after-sale service.

1. Warranty period

The warranty period of the product is 12 months from purchasing or 20 months from production date that on the nameplate, if exceed any one of this two period, we will determine that the product is beyond the warranty period. However, if the fault is caused as follows, no matter if it is warranty period, we will ask for the cost of repair.

- 1) Wrong operation, change this product by yourself or unreasonable maintenance, etc..
- 2) Operated beyond the standard specification.
- 3) After being purchased, the product is damaged due to falling down or transportation, etc..
- 4) Caused by earthquake, fire, wind accident, lighting strike, abnormal voltage, other Act of God or quadratic damage, etc..

2. After-sale service

- 1) When the operation state is not in right condition, please check it and find the cause according to the operating manual.
- 2) Please contact with the sales agency or after-sale service window, agency of our company in the operating manual when the machine occurs faults.
- 3) Maintenance during warranty period: Faults caused by production problem, we will offer the maintenance, please correctly fill the Warranty for Sanyu soft starter in detail, otherwise, we would ask for the cost of repair.
- 4) Maintenance beyond the warranty period: Offer basic maintenance only for maintaining the function, and then ask for the cost repair for further maintenance according to customer's requirement.

Warranty for soft starter of Sanyu

Customer's name		Chief name		Tel	
Address				Fax	
Model	SJR2- KW	Ex-store code			
Shop name			Purchasing date	Date:	
Address			When does the fault show?	Date:	

— Fault state —

Application			Motor	_____ KW	Pole	Model _____
When does it show?	During continuous running	During speeding up	During speeding down	Switch on Others ()		
What does it display when the fault shows	Alarm display () Does the keyboard display () Output voltage (Yes No)					
Run after resetting	Possible	Impossible	Reset method	Keyboard panel	Terminal	Power supply Others ()
Control terminal applied	0 1, 0 2	0 3, 0 4	0 5, 0 6	0 7	0 8	0 9 1 0 1 1, 1 2 Others ()
Working time		Find the frequency	/	Installation place		
Is power on ?	Yes No	Is there any machine abnormal around it?	Yes No	Last fault	Yes(Show _____ times) No	

TESLAKALA.COM

The technical parameters are subject to change, without prior notice.
Shanyu reserves the right to the interpretation of the abovementioned materials.
All rights reserved.
The diagrams in this manual are only for reference.
Printed with ecological paper
March 2009-11