

# PR12-D12

12 Steps



## Reactive Power Control Relay

- ✓ Banks
- ✓ Markets
- ✓ Oil Stations
- ✓ Schools
- ✓ Workshops
- ✓ Hotels



# Contents

---

	Introduction .....	1
	Warnings .....	1
	Specifications.....	2
	General .....	3
	Step Panel .....	3
	Making the Connections .....	3
	Connections .....	4
	Alerts .....	4
	Commisioning .....	5
	Main Screens .....	6
	% Instant Consumption.....	6
	Cos $\Phi$ .....	6
	PF Power Factor .....	7
	$\Sigma$ Accumulated Energy Ratios.....	7
	Steps .....	7
1.	MENU .....	8
1.1	Harmonics .....	8
1.2	Step Indicator .....	8
1.3	Voltage, Current, Frequency.....	8
1.4	Power .....	8
1.5	Energy .....	9
1.6	Counter Index .....	9
1.7	Settings .....	9
1.7.1	Target Cos $\Phi$ .....	10
1.7.2	Switch on(decharge) Time .....	10
1.7.3	Switch off Time .....	11
1.7.4	Switch min. Time .....	11
1.7.5	Limit of Inductive Penalty.....	12
1.7.6	Limit of Capacitive Penalty.....	12
1.7.7	Current Transformer (Primary) Value ...	12
1.7.8	Number of Steps .....	12
1.7.9	Advanced Set-up Menu.....	13
1.7.9.1	$\Delta T$ on Transition(Delay) Time.....	13
1.7.9.2	$\Delta T$ off Transition(Delay) Time.....	13
1.7.9.3	Current Flow Direction Detection .....	13
1.7.9.4	Fast Step Mode.....	14
1.7.9.5	Step Parameters.....	14
1.7.9.5.1	Continuous Step Power Detection .....	14
1.7.9.5.2	Constant Step Function .....	14
1.7.9.5.3	Step Synch. Time Sharing .....	14
1.7.9.5.4	Enter Step Powers .....	15
1.7.9.5.5	Delete Step Powers .....	15
1.7.9.5.6	Step Change Control .....	16
1.7.9.6	Alarm & Protection .....	16
1.7.9.6.1	Alarm Control .....	16
1.7.9.6.1.1	Phase Alarms .....	17
1.7.9.6.1.1.1	Over Voltage.....	17
1.7.9.6.1.1.2	Under Voltage .....	17

# Contents

---

1.7.9.6.1.1.3 Over Current.....	17
1.7.9.6.1.1.4 Over Compensation.....	17
1.7.9.6.1.1.5 Under Compensation .....	17
1.7.9.6.1.1.6 No Phase .....	17
1.7.9.6.1.1.7 THD on Voltage.....	17
1.7.9.6.1.1.8 HD on Voltage.....	17
1.7.9.6.1.1.9 THD on Current.....	17
1.7.9.6.1.1.10 HD on Current.....	17
1.7.9.6.1.2 General Alerts.....	18
1.7.9.6.1.2.1 Connector Failure(1).....	18
1.7.9.6.1.2.2 Connector Failure(2).....	18
1.7.9.6.1.2.3 Connector Failure(3).....	18
1.7.9.6.1.2.4 Total Over Compensation.....	18
1.7.9.6.1.2.5 Total Under Compensation.....	18
1.7.9.6.1.2.6 System Failure.....	18
1.7.9.6.1.2.7 Over Temperature.....	18
1.7.9.6.1.2.8 Voltage Connection Failure.....	18
1.7.9.6.1.2.9 Step Change .....	18
1.7.9.6.1.2.10 Step Zero.....	18
1.7.9.6.1.2.11 Modbus Security Failure.....	18
1.7.9.6.2 Alarm Setting Values. ....	19
1.7.9.6.2.1 Over Voltage Setting .....	19
1.7.9.6.2.2 Low Voltage Setting .....	19
1.7.9.6.2.3 Over Temperature .....	19
1.7.9.6.2.4 Voltage THD Setting .....	20
1.7.9.6.2.5 Voltage HD Setting .....	20
1.7.9.6.2.6 Current THD Setting .....	20
1.7.9.6.2.7 Current HD Setting .....	20
1.7.9.6.3 Fan Settings .....	21
1.7.9.6.3.1 Fan Temperature Value .....	21
1.7.9.6.3.2 Fan Output .....	21
1.7.9.6.4 Step Protection Function.....	21
1.7.9.6.4.1 Temperature Protection.....	21
1.7.9.6.4.2 Voltage Protection.....	21
1.7.9.6.4.3 Harmonic Protection.....	22
1.7.9.7 Password Settings.....	22
1.7.9.7.1 Password Enable/Disable.....	22
1.7.9.7.2 Change Password .....	22
1.7.9.8 Generator Parameters.. ....	23
1.7.9.8.1 Tan $\Phi$ 2-Cos $\Phi$ 2 Target.....	23
1.7.9.8.2 Generator Input Enable/Disable.....	23
1.7.9.9 MODBUS RTU Settings .....	23
1.7.9.9.1 Data Write Protection.....	23
1.7.9.9.2 Data Read Protection.....	23
1.7.9.9.3 Data Write Password.....	16
1.7.9.9.4 Data Read Password.....	24
1.7.9.9.5 Port Settings .....	24
1.8 Factory Defaults .....	25

## Introduction

All the information you need to know and the warnings regarding 3 Phase controlled PR12-D12 reactive power control relay is described in the user manual.

Prior to taking the circuit for the device read this booklet carefully for your system and your own safety. Do not act without getting touch with our company for the issues that can not be understood.

### Spain:

**Headquarter&Manufacturing Centre**  
**RTR Energia, S.L.**  
C/ Gavilanes, 11 Bis  
Pol. Ind. Pinto - Estación  
28320 Pinto (Madrid) • SPAIN  
Tel: (+34) 916 916 612  
Fax: (+34) 916 912 257  
E-mail: info@rtr.es  
www.rtr.es

### Chile:

**Manufacturing Centre**  
**RTR Energía Chile, S.A.**  
La Estera nº 668  
Panamericana Norte, Km. 17  
Laleo Valle Grande-Lampa • CHILE  
Tel: (+56) 2 2328 44 00  
Fax: (+56) 2 2738 69 11  
E-mail: dnachile@rtr.cl  
www.rtr.cl



## Warnings

- 1- The device should be commissioned and programmed by the authorized and certificated persons. If necessary, checks should be made by that person again.
- 2- As compensation is a complex system, subscriber's system are advised to keep under control by licensed - professional electrical engineers and technicians that company owned or agreed.
- 3- Do not open the device and not let it open. There are not any parts in the device that the user or someone can cut in.
- 4- Prior to making electrical connections to the terminals of the device, make sure that there is no energy in the cable and terminals. There shouldn't be energy at the control panel.
- 5- Do not use the device for different purposes other than compensation system.
- 6- Fix the device tightly on the control panel with the apparatus given on the device without hanging around.
- 7- Do not interfere to the keys on the front panel with an object other than your fingers.
- 8- Wipe your device with dry cloth being sure to disconnect the power. Water or chemicals used for cleaning damage to the device.
- 9- Make sure that the terminal connections are made in accordance with the connection scheme and without causing contact problem (loose binding or multiple copper cables touching to each other, etc.), prior to commissioning (supplying energy) of your device.
- 10- Use compensation contactors compatible to the power of the capacitor in your compensation system. Select the fuses in the power line of the capacitor compatible to the current of the capacitor.
- 11- Select the current value of the fuses connected to the C1, C2 terminals which are input of contact phase considering the sum of the current drawn by the coils of connectors in each group (senary). In case of using connectors with high current coil, auxiliary relay must be used to prevent damage to the contact outputs of the device.
- 12- The alerts and the warnings above are just for your security. In case of not applied, RTR Energia S.L. or its seller is not responsible for undesirable conditions.

## Specifications

- ✓ Easy to use with English menu
- ✓ Advanced dynamic software
- ✓ Easy to commissioning
- ✓ Large color LCD screen ( 320 x 240 pixel 3,2" )
- ✓ Enough number of steps needed ( 12 steps )
- ✓ Quickly and accurately detection power of capacitors
- ✓ Normal or fast operation mode selection
- ✓ Connecting triphase, double-phase and single-phase capacitor
- ✓ Connecting shunt reactors
- ✓ Displaying the current and voltage up to the 31. harmonic simultaneously with the graphics
- ✓ Total current and voltage harmonics
- ✓ Displaying the phase or phases to which connected capacitors in color on the screen
- ✓ Making compensation even at low currents (min. 10 mA)
- ✓ 40 ms measurement, calculation and response time
- ✓ Making compensation for the generator according to the second Cos  $\Phi$ 2 set-up
- ✓ Displaying many guiding screens
- ✓ operating system is used in the micro-processor
- ✓ Computer communicated (RS485 MODBUS RTU)
- ✓ Password protected
- ✓ For balance or unbalance operatings
- ✓ Ensuring equal-aging of the capacitors in the same power
- ✓ Informing the user for the capacitors losing power
- ✓ Measuring temperature
- ✓ Following electrical parameters of three phases at the same time

■ Voltage of phases	$V(L_{1,2,3} - N)$
■ Current of phases	$I(L_{1,2,3} - N)$
■ <b>Cos<math>\Phi</math></b> value of phases	$\text{Cos}\Phi_{(1,2,3)}$
■ <b>Tan<math>\Phi</math></b> value of phases	$\text{Tan}\Phi_{(1,2,3)}$
■ Power factor value of phases	$\text{PF}_{(1,2,3)}$
■ Active powers	$\Sigma P, P_1, P_2, P_3$
■ Inductive reactive powers	$\Sigma Q_{(ind)}, Q_1_{(ind)}, Q_2_{(ind)}, Q_3_{(ind)}$
■ Capacitive reactive powers	$\Sigma Q_{(Cap)}, Q_1_{(Cap)}, Q_2_{(Cap)}, Q_3_{(Cap)}$
■ Apparent powers	$\Sigma S, S_1, S_2, S_3$
■ Total active energy	$\Sigma \text{Wh}$
■ Total inductive reactive energy	$\Sigma \text{VARh}_{(ind)}$
■ Total capacitive reactive energy	$\Sigma \text{VARh}_{(Cap)}$

## General

Electricity networks are gradually overloaded as a result of increasing use and demand of emerging technologies in all sectors. While the compensation becomes a nightmare for the companies having unstable load, even the companies having stable load in the past have now difficulties to provide reactive compensation. Therefore, the period of reactive power relays measured by single-phase will be over in the close future.

Facilities are provided to the users with many graphics and animation by using large 3.2" color LCD screen on the device. Moreover, the microprocessor in the device is running very fast and an operating system is used. This provides to reach all transactions running simultaneously.

 In case the **blue led** on the lower left corner of the front panel of the device flashes, this means it is close to the value of penalty % and authorized persons should be informed as soon as possible. This is also useful in terms of taking the attention of the end-user in case of penalty who does not know this functional issue.

## Step Indicator

A step indicator made by symbols that can be easily realized by the user, is located on the upper part of the screen of PR12-D12. No matter which part of the user in, this panel is always located on the top of the screen. Step numbers, the phase or the phases they are connected, whether these are informed or not, whether they are capacitors or reactors, whether the steps and the generators are activated or not and control panel temperature value can all be observed on this panel at the same time.

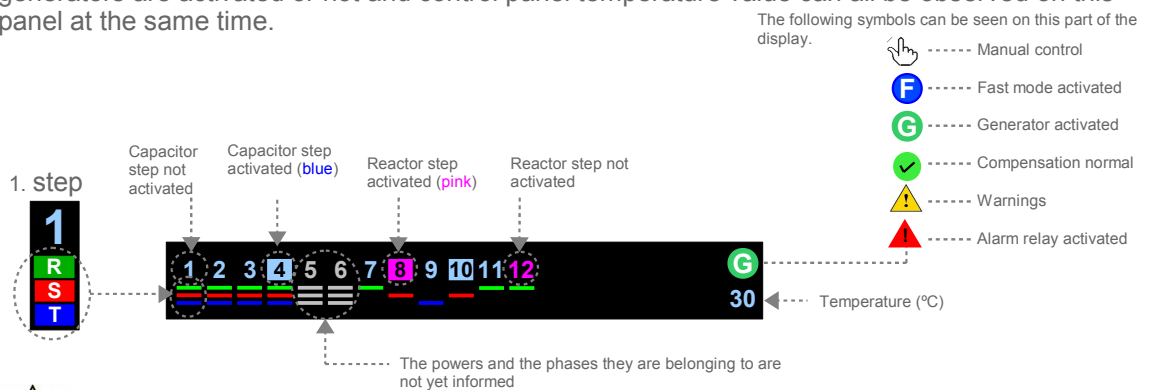

LCD screen is used in PR12-D12 to provide it to be more easier in use and be intelligible. In case the keys are not pressed for a long time, the device switch to the screen saver mode to extend the life of the display, and only the step indicator shown on the the top scrolls down step by step from the top to the bottom of the screen. Thus, the condition of the steps can be continued to be monitored. In case of pressing on any key, the main screen image appears again.

## Making the Connections

- The connections of the device should be made while the system is energy-free.
- PR12-D12 should be connected as shown in the connection diagram.
- Three phase and neutral connections should be made to the voltage input. Phase should not be given instead of neutral. Otherwise the device can be damaged.
- Current connections should be made as to match the same phase with the same current transformer. Scheme should be followed.
- The value of the selected current transformers should not be under the real load values but should be X/5 amper. It is also advised to choose 0.5 class.
- Connect the "C1, C2" common phase inputs to the same phase with FF type fuses separately. Select the fuses to be used according to the specified current value.
- The outputs of the steps are not needed to be made in any order. However, the first 6 steps can consist of triple-phase capacitor groups. It is recommended to connect single-phase capacitors to the second and third 6 steps and, to connect capacitors or reactors to the third 6 steps in terms of accepting the statements in this manual.
- Make the connections to the generator if it is used.
- Make RS485 connection.
- Do not energize the device without ensuring the connections checked by measurement instruments.

# Connections

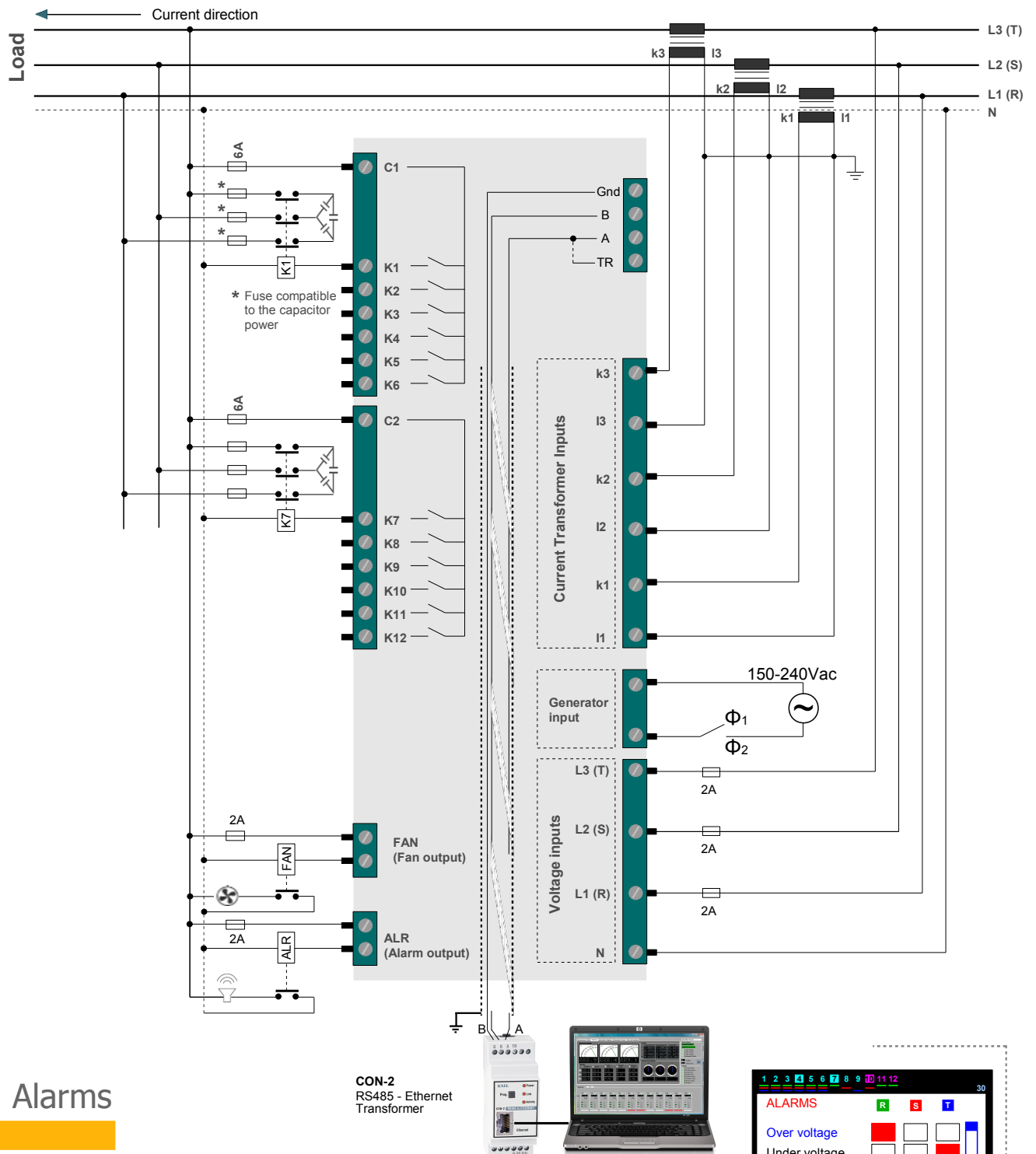

# Alarms

In case of alarm in the device, an exclamation mark appears under the main screen. Pressing the exclamation key, the alert page shown on the right side can be displayed on the screen as well as a warning page can only be displayed. In case of more than one alert, they are ranked one under the other according to the priority.

Meanwhile, the phase in which the alarm is given displayed on the screen. Arrow keys can move between the alarms. In case "Select" key is pressed during on any alarm (format is blue colour), warning page of that alert comes to screen. The essential corrections should be made by taking into consideration the recommendations made therebefore. Alarm page is back by pressing the "Exit" key.

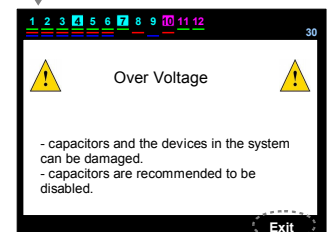
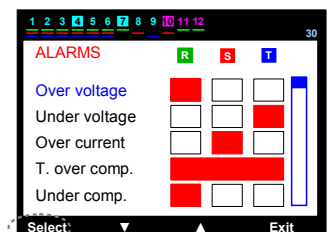

# Commissioning

## 1. Step : Number of Steps

When commissioning the first time, start values are loaded into the device. Then it requires to enter the number of steps. In this case, the screen on the right side will be displayed. The number of step is set-up to the required value by the direction keys and "Apply" is selected. In case "Okay" key is pressed, saves the change. Or, in case no key is pressed, when the time is over on the screen, it switches to the section in which the current transformer ratio is inserted by taking 12 steps in the memory.

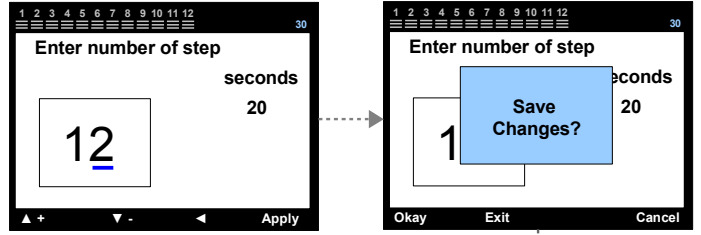

## 2. Step : Current Transformer Ratio

The line on which the blue bar locates, is set-up to the required value by using the direction keys and switch to the next side by pressing the left direction key. Inserting the complete primary value, "Apply" key is pressed. In case of pressing "Okay" key, the change is saved.

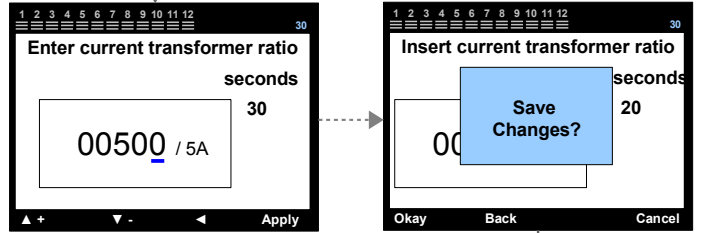

## 3. Step : Determine of Current Transformer Directions

The device automatically switches to the internalization of current polarity directions mode. In this case, it is required to draw enough current from each phase. If enough current can not be drawn from any phase, the device warns as "current flow directions not detected" and shows the phase or phases which are not internalized by ??? marks. When the total of current polarity directions are internalized, the device switches to the automatic capacitor power internalization mode.

P.S.: There is no need to press on the main screen key normally.

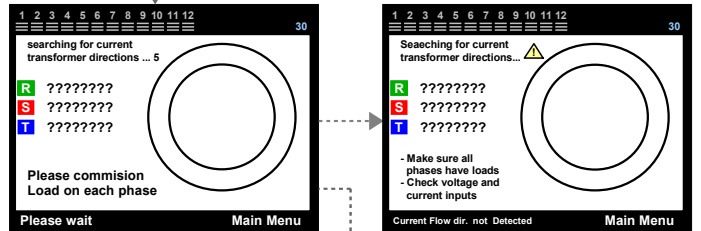

## 4. Step : Learning of step powers

Device tries to identify capacitor powers and the phases to which they connected, by activating and then removing the steps in sequence. It is recommended the closure of variable loads in the system to ensure instant internalization during this process. If required, the user presses the "Make the steps internalize" key and can make the system internalize by himself. The automatic internalization is put on hold in the meantime. The step is not internalized automatically as long as the user is in the "Make the steps internalize" menu.

P.S.1: There is no need to press on the main screen key normally.

P.S.2: Despite of the variable loads are disabled, the connections of the device should be checked again in case any power of the steps and their connections are not internalized for a long time.

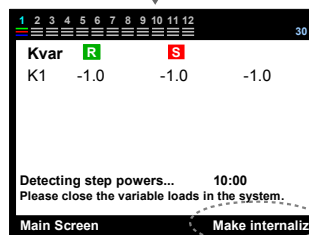
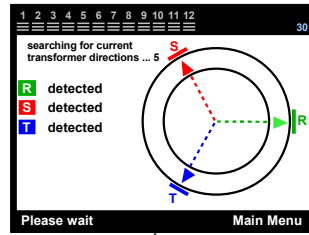

## 5. Step (Main Screen)

When all the steps are internalized, the main screen page comes up and the device starts operating in automatic mode.

P.S.1: It's required to enter the Menu for the parameters the user need to set-up. It's recommended to see the specifications of the device by navigating in the menu.

P.S.2: Unless the user disable the password protection, some transactions (eg. set-up, deleting the energy) will be password protection.

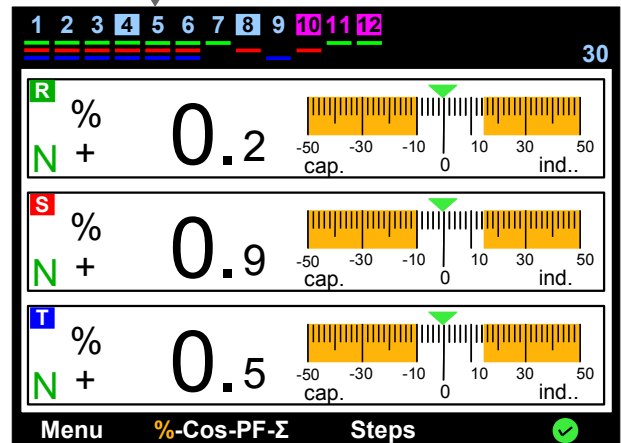



# Main Screens

PR12-D12 has color 3.2 "TFT screen. The switch between pages and the key terms are provided on the bottom line of the display. The keys have different meanings in different pages. Steps, to which phase or phases they are connected, whether they are capacitors and/or reactors, temperature value, whether the fan and the generator are activated or not, all these can be observed on all main screens.

## % (Instant Consumptions)

Instant consumption % values of each phase and their scaled representation, the normal, under and over compensation of the phases, their inductive-capacitive characterized loads and whether the system is normal or not according to the accumulated energy can be observed on consumptions page.

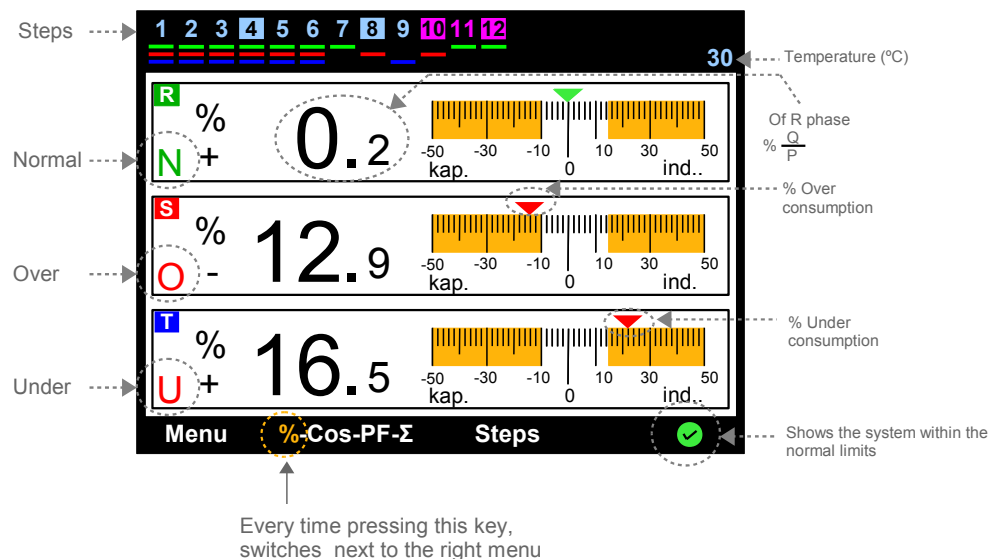

## cos (cosΦ)

Instant cosΦ value of each phase, angular representation on triple-phase vector diagram, the angle (Φ) values, the normal, under and over compensation condition of the phases, their inductive-capacitive characterized loads and whether the system is normal or not according to the accumulated energy can be observed on this page.

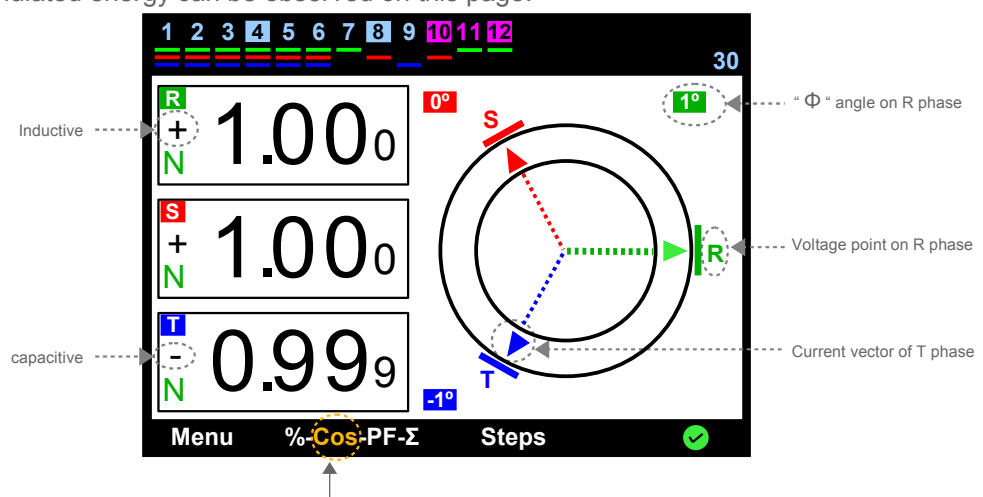

## PF Power Factor

The instant reactive power value (Q), active force values (P), power factor values (PF) calculated from their ratios (Q / P), vectoral representation of these forces, inductive - capacitive characterized loads, whether the systems is normal or not as per the accumulated energy can be monitored.

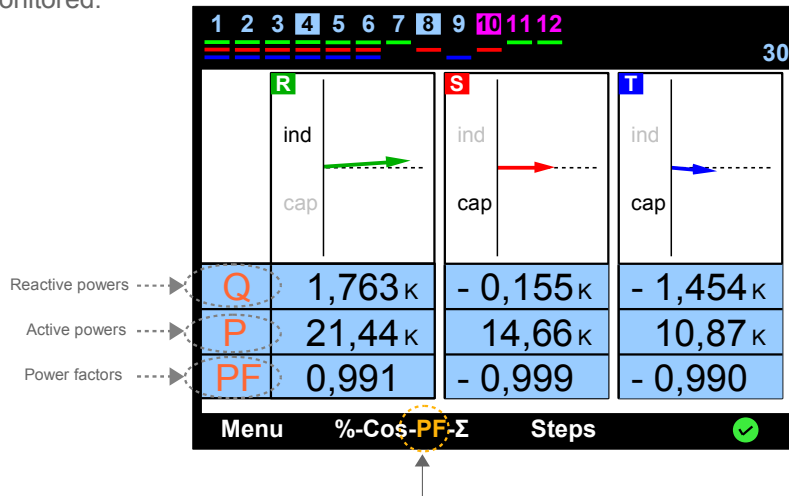

## Σ Ratios of Accumulated Energy

Accumulated energy ratios of each phase, total energy ratios and their scaled representation can be monitored. This screen is very useful in terms of realizing the characters of loads connected to the phases and enabling the user to take the necessary actions and make the corrections. Whether the system is under penalty according to the total energy ratios can also be monitored.

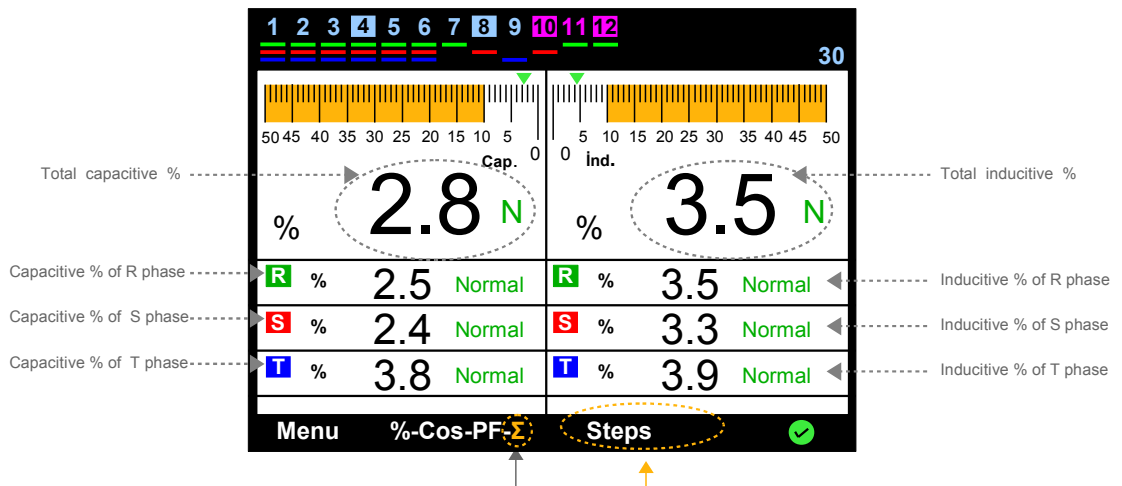

## Steps

This is the section used to see the conditions (activated-deactivated-holding) of steps more clearly, to examine the reactive power of the system or for commissioning and disabling the steps manually.

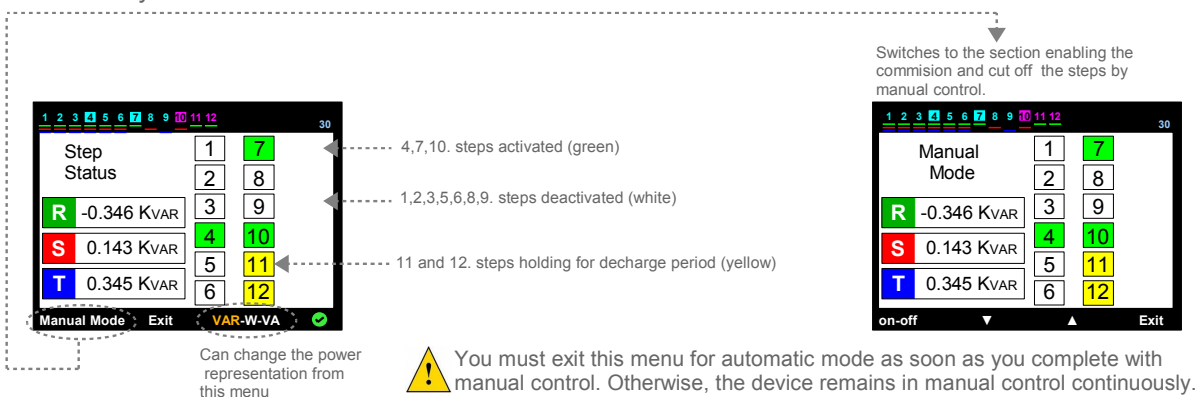

# 1. MENU

This is the section in which many of the electrical measurements are monitored and set-up are made. The parameters are accessed by direction keys in the menu, parameters are inserted by “Select” key and exit from the parameters by “Exit” key.

**P.S.:** Set-up section can only be accessed by password.

## 1 1 Harmonics

Displays the harmonic amplitude and % values of voltage as well as current of three phases up to 31.harmonic in terms of linear or logarithmic on colour graphics screen.

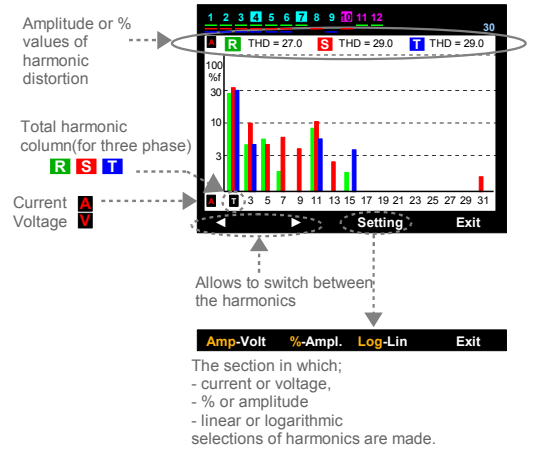

## 1 2 Step Monitoring

All steps can be accessed by up and down keys. Step information of the step with red frame (  ) among the step boxes is displayed on the left side of the screen while moving with direction keys.

The information regarding the runtime of all steps, number of switching, phase or phase to which they are connected, total power values and whether they are capacitor or reactor can all be accessed.

These values can be deleted when you make a change in step. “Select” key is pressed for deleting on the related step. Selecting the required type of deleting from the sub-screens shown on the right side, operation can be realized.

## 1 3 Voltage, Current, Frequency

This is the section in which the current, voltage and frequency drawn from the system are monitored.

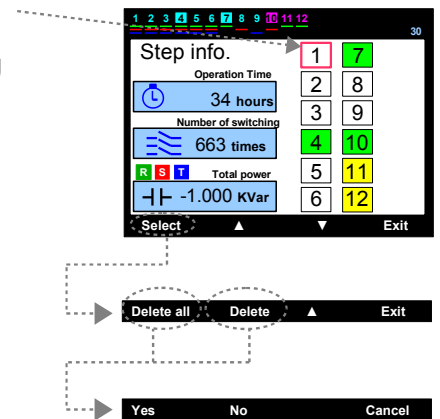

## 1 4 Power

This is the section in which active, reactive and apparent powers drawn from each phase and, total active, reactive and apparent powers are monitored.

These values can be observed by selecting “Powers” or “Total” at the bottom of the screen.

	R	S	T
V	219.8	219.2	220.2
A	60.48	71.32	43.29
f	49.9 Hz		

**Exit**

	Total
Q Var	0.864 kVar
P W	33.17 kW
S VA	33.18 KVA

**Powers**   **Total**   **Exit**

## 1 5 Energy

This is the section in which the active, reactive (ind. and cap.) and apparent energies consumed one by one in each phase and, the total active, reactive (ind. and cap.) and apparent energy consumed in total of the system are monitored.

If required, "Reset" selection is pressed (eg. when the counter is read for invoicing purpose). Entering the password, "Delete counters?" question appears on the screen. In case of pressing "Yes", all the counters are deleted.

P.S.: Password process is described in this section. 1 7 9 7

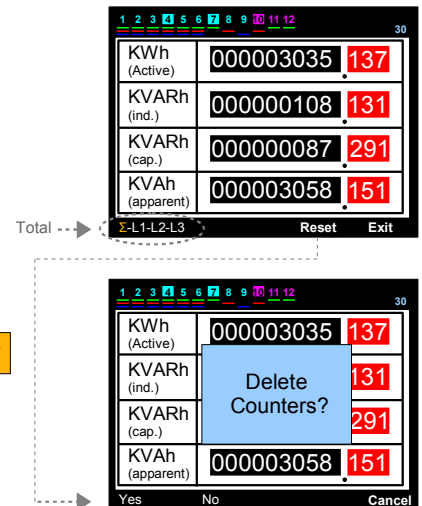

## 1 6 Counter Index

The index value of electrical counter connected to the plant is entered in this section. Thus, the energies recorded by electrical counter are compared.

P.S.: PR12-D12 does not use these values for compensation.

Press "Settings" selection first in order to enter energy values.

Sub-screen will change and red frame will appear on the index line. Red frame is moved to the line of which value will be entered by using direction keys and, "Select" key is pressed.

An underline in blue colour appears in the line with red frame. The value of number in the digit under which the blue line is, is entered by using up and down keys. Then, move to the next digit by left key. When all the digits are changed with the same figures in the counter, "Apply" key is pressed. When the values of all lines are entered, "Okay" key is pressed and, when "Save Changes" appears on the screen, the data are kept in the memory by pressing "Okay" key.



## 1 7 Settings

This is the section in which you can find all set-up regarding the device. Password is entered. After commissioning of PR12-D12, any change of parameters is not required normally. However, it may be necessary for the users requiring to create special conditions or make some adjustments.

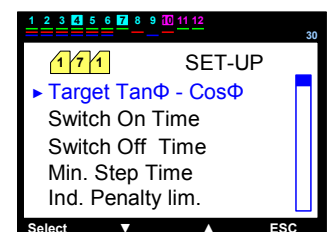

## 1 7 1 Settings - Target Tan $\Phi$ ( % $\pm 75$ ) – Cos $\Phi$ ( $\pm 0,800$ )

This is the section in which the required % value of the system is entered. Cos $\Phi$  value corresponding to the % value is displayed automatically on the other side. The value is setup to the required step by using up and down keys starting from the digit where the blue line is. Then, left key is pressed and the blue line moves next to left digit. All values are entered in the same way by using the up and down keys. Moving the blue sub-line to the digit where the sign is by using left key, the sign can be changed by pressing upwards key. (+) expresses inductive, (-) expresses capacitive sections..

“Apply” key is pressed to take the target value into memory. “Save Changes” message will appear on the screen. When “Okay” key is pressed, the value is taken into the memory.

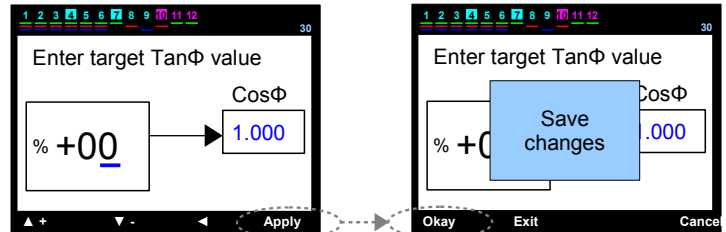

## 1 7 2 Settings – Switch on Time (decharge) (1 – 600 sec)

This is the entrance section of the value of decharge period (sec) held for preventing the capacitor to activate again without discharging in the same step in case of requirement, after release of the activated step. The value is setup to the required step starting from the digit under which the blue line is, by using up and down keys. Then left key is pressed and the blue line moves next to left digit. All the values are entered in the same way by using up and down keys. Press “Apply” key in order to take the period of step activating into memory. “Save changes” message will appear on the screen. When “Okay” key is pressed, the value is taken into memory. Period of activating line is subjected to a function with the % value obtained from the ratio of energies. In case % value is getting close to the inductive penalty line value, the time is reduced automatically by the device. If necessary, compensation speeds up; and if not, it slows down by means of dynamic control of step activating, and continuously do not make fast moves unnecessarily.

P.S.: Step activating time counts only for capacitor released newly. If necessary and a close solution is found in another step, device activates the other option on time and the compensation is not delayed.

If it's not required the device to respond so quickly, holding period between the steps can be extended to delay receiving process by increasing the value of  $\Delta T$  on switching time described in the next **1 7 9 1** chapter.

P.S.3:

In case of selecting the switch on time less than min.step time, device accepts the switch on time as constant time value.

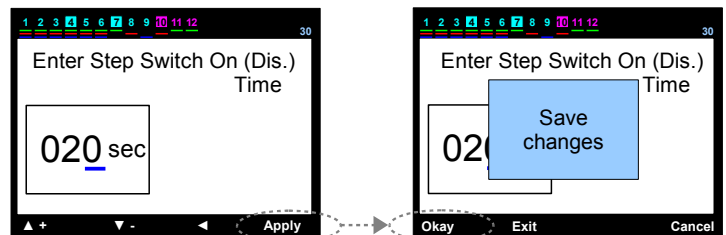

Other Relays : They proceed the step activating transaction with constant time adjusted. If the time is not over, they will wait for the deadline. This causes delays in the compensation.

PR12-D12 : It collects the energies (ind., cap., active) consumed. Step activating and de-activating periods are decreased or increased automatically by the device according to the consumed energy.

P.S.: The energies consumed in PR12-D12 and the % values are calculated separately for each phase. Therefore, step activating and de-activating periods of each phase can vary. For instance, while the step activating time for R-phase down to 2 seconds, the one for S-phase can be 7 sec. PR12-D12 analyze the system phase by phase and set-up the compensation rate for each phase separately.

The most simple explanation regarding the ratio of energy of step activating period has been given below.

In fact the function consists of much more complicated and an array of fuzzy logic. Step sub-period (min) determines the lowest time value of level activating time which can be reduced by the device.

This parameter can be specified by the user.

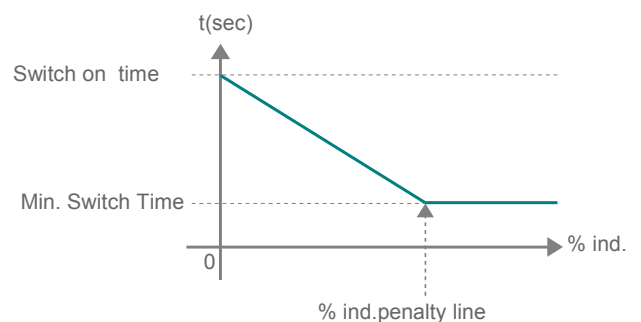

### 1 7 3 Settings – Switch Off time (1 – 600 sec)

This is the section in which the value of switch off time is entered (sec). The value is setup to the required step by using up and down keys starting from the digit where the blue line is. Then, left key is pressed and the blue line moves next to left digit. All values are entered in the same way by using the up and down keys.

Press “Apply” key in order to take the switch off time into memory. “Save changes” message will appear on the screen. When “Okay” key is pressed, the value is taken into memory.

Period of activating line is subjected to a function with the % value obtained from the ratio of energies. In case % value is getting close to the capacitive penalty line value, the time is reduced automatically by the device. If necessary, compensation speeds up; and if not, it slows down by means of dynamic control of switch off time, and continuously do not make fast moves unnecessarily.

P.S.1: Switch off time counts only for capacitor activated newly. If necessary and a close solution is found in another step, device deactivates the other option on time and the compensation is not delayed.

If it's not required the device to respond so quickly, holding period between the steps can be extended to delay releasing process by increasing the value of  $\Delta T$  off switching time described in the next 1 7 9 2 chapter.

P.S.2: In case fast operating mode is selected, switch off time of the device is 200 msec.

It's independent from switch off time which is set-up.

P.S.3: In case of selecting the switch off time less than min.step time, device accepts the switch off time as constant time value.

Other Relays : They proceed the step de-activating transaction with constant time adjusted. If the time is not over, they will wait for the deadline. This causes delays in the compensation.

PR12-D12 : It collects the energies (ind., cap., active) consumed. Step activating and de-activating periods are decreased or increased automatically by the device according to the consumed energy.

P.S.: The energies consumed in PR12-D12 and the % values are calculated separately for each phase. Therefore, step activating and de-activating periods of each phase can vary. For instance, while the step de-activating time for R-phase down to 2 seconds, the one for S-phase can be 7 sec. PR12-D12 analyze the system phase by phase and set-up the compensation rate for each phase separately.

The most simple explanation regarding the ratio of energy of step de-activating period has been given below.

In fact the function consists of much more complicated and an array of fuzzy logic. Level sub-period (min) determines the lowest time value of step de-activating time which can be reduced by the device.

This parameter can be specified by the user.

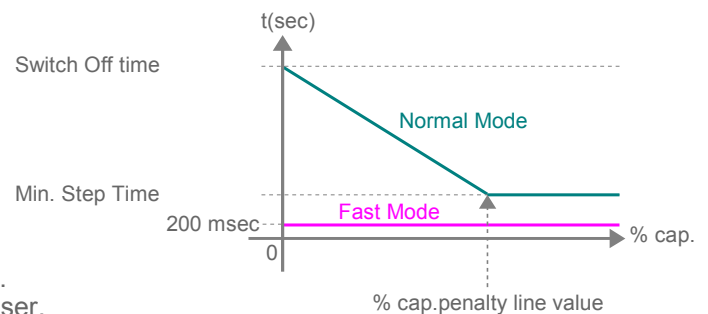

### 1 7 4 Settings – Min. Switch Time (1 – 600 sec)

This is the section in which the value of step sub-period (min) is entered (sec). The value is setup to the required step by using up and down keys starting from the digit where the blue line is. Then, left key is pressed and the blue line moves next to left digit. All values are entered in the same way by using the up and down keys.

Press “Apply” key in order to take the step sub-period (min) time into memory. “Save changes” message will appear on the screen. When “Okay” key is pressed, the value is taken into memory.

Period of activating line is subjected to a function with the % value obtained from the ratio of energies. It represents the minimum value of both step activating and de-activating time which can be changed by the device.

Step sub-period is not taken into account during fast mode.

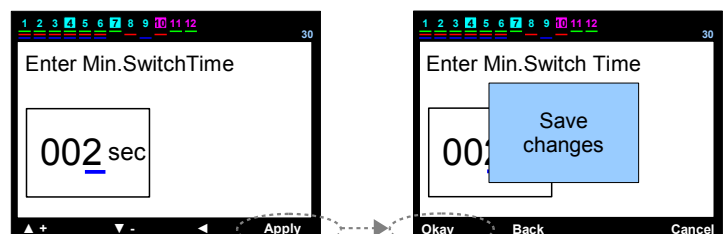

### 1 7 5 Settings – Inductive penalty limit ( % 3 – 50 )

This is the section in which the limit value of inductive/active % acceptable in compensation, is entered. This value is determined by electric distribution company and is recommended to setup a value slightly lower than requested to avoid penalty. The value is setup to the required step by using up and down keys starting from the digit where the blue line is. Then, left key is pressed and the blue line moves next to left digit. All values are entered in the same way by using the up and down keys.

Press “Apply” key in order to take the inductive penalty line into memory. “Save changes” message will appear on the screen. When “Okay” key is pressed, the value is taken into memory.

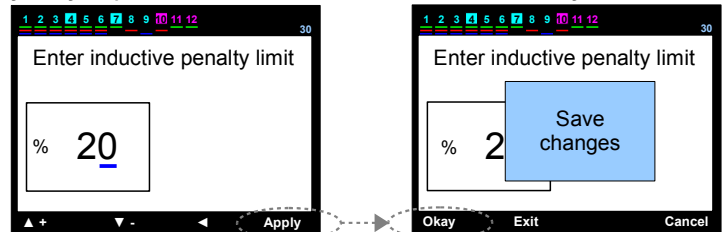

### 1 7 6 Settings – Capacitive penalty limit ( % 3 – 50 )

This is the section in which the limit value of capacitive/active % acceptable in compensation, is entered. This value is determined by electric distribution company and is recommended to setup a value slightly lower than requested to avoid penalty. The value is setup to the required step by using up and down keys starting from the digit where the blue line is. Then, left key is pressed and the blue line moves next to left digit. All values are entered in the same way by using the up and down keys.

Press “Apply” key in order to take the capacitive penalty line into memory. “Save changes” message will appear on the screen. When “Okay” key is pressed, the value is taken into memory.

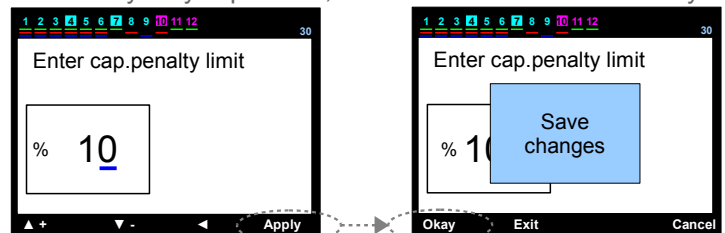

### 1 7 7 Settings – Current Transformer (Primary) value ( 5.....10000 / 5A )

This is the section in which the primary value of current transformers in compensation system, is entered. The value is setup to the required step by using up and down keys starting from the digit where the blue line is. Then, left key is pressed and the blue line moves next to left digit. All values are entered in the same way by using the up and down keys. Press “Apply” key in order to take the current transformer (primary) value into memory. “Save changes” message will appear on the screen. When “Okay” key is pressed, the value is taken into memory.

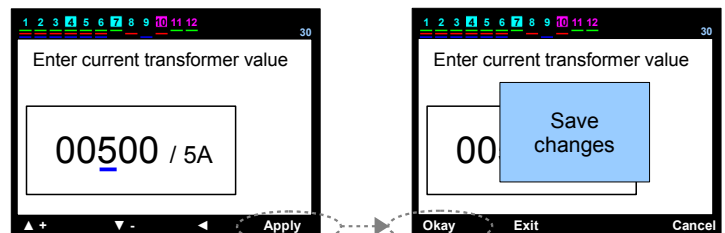

### 1 7 8 Settings – Number of Steps ( 3 – 12 )

This is the section in which the number of steps will be used for compensation, is entered. The value is setup to the required step by using up and down keys starting from the digit where the blue line is. Then, left key is pressed and the blue line moves next to left digit. All values are entered in the same way by using the up and down keys. Press “Apply” key in order to take the number of steps into memory. “Save changes” message will appear on the screen. When “Okay” key is pressed, the value is taken into memory.

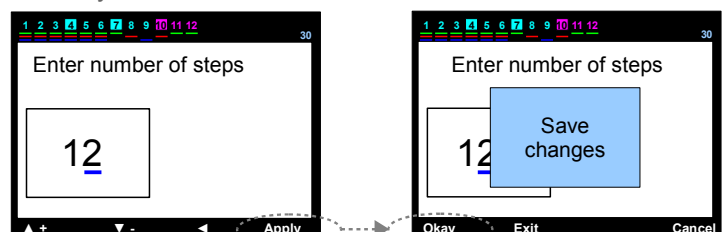

## 1 7 9 Settings – Advanced Setting Menu

This is the section in which the parameters are not used very often.

### 1 7 9 1 Settings – Advanced Setting Menu - $\Delta T$ on Delay Time (0 – 3600 sec)

This is the section in which the holding time between steps during step activating, is entered. The value is setup to the required step by using up and down keys starting from the digit where the blue line is. Then, left key is pressed and the blue line moves next to left digit. All values are entered in the same way by using the up and down keys. Press “Apply” key in order to take  $\Delta T$  on switching time into memory. “Save changes” message will appear on the screen. When “OK” key is pressed, the value is taken into memory.



⚠ In case at least one of  $\Delta T$  on or  $\Delta T$  off time is setup to any value rather than zero and the device runs in quick mode, quick mode is canceled automatically.

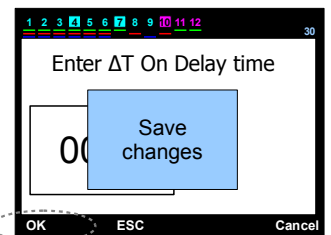
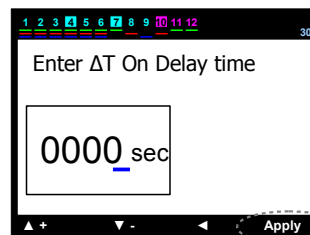

### 1 7 9 2 Settings – Advanced Setting Menu - $\Delta T$ off Delay Time (0 – 3600 sec)

This is the section in which the holding time between steps during step de-activating, is entered. The value is setup to the required step by using up and down keys starting from the digit where the blue line is. Then, left key is pressed and the blue line moves next to left digit. All values are entered in the same way by using the up and down keys. Press “Apply” key in order to take  $\Delta T$  off switching time into memory. “Save changes” message will appear on the screen. When “Okay” key is pressed, the value is taken into memory.



⚠ In case at least one of  $\Delta T$  on or  $\Delta T$  off time is setup to any value rather than zero and the device runs in fast mode, quick mode is canceled automatically.

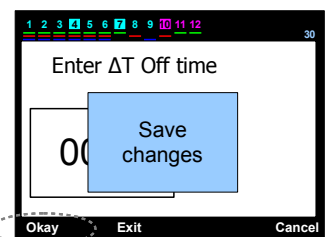
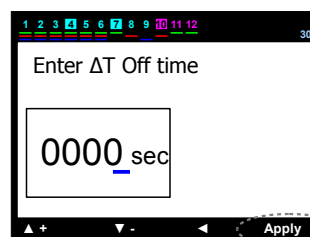

### 1 7 9 3 Settings - Advanced Setting Menu – current flow direction detection

This is the section in which the function of searching of current transformer polarity directions are activated or de-activated. In case “Activated” is selected, internalization of current transformer direction is always “On”, and only checks the directions when the device is powered. If “Off” is selected, then the device internalize the current transformer directions at once and do not change it. The “Off” choice should be selected for some loads (producing negative active load).

The required status for function is selected by using the up and down keys. Press “Apply” key in order to take this parameter into memory. “Save changes” message will appear on the screen. When “Okay” key is pressed, the value is taken into memory.

⚠ In case internalization of direction is activated, internalization of current transformer direction is always “On”, and only checks the directions when the device is powered. In case the ends of current are changed while the device is running, it can not detect this. It's needed to turn off and on again.

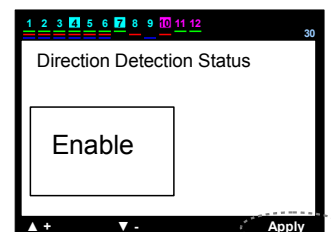



## 1 7 9 4 Settings – Advanced Setting Menu – Fast Step Mode

This is the section in which the fast step mode is enable or disable. In case “enable” is selected, the device can activate many steps at the same time as well as de-activate them. If “Off” is selected, then the device makes only one step attempt at each time. The required status for function is selected by using the up and down keys. Press “Apply” key in order to take this parameter into memory. “Save changes” message will appear on the screen. When “Okay” key is pressed, the value is taken into memory.

! In case fast step mode is activated, the device set  $\Delta T$  on and  $\Delta T$  off times to zero automatically.

! If fast step mode is selected, then the contactors which will be used, must be absolutely compensation contactors, and the step activating time (discharge) that the producers recommend, should be entered.

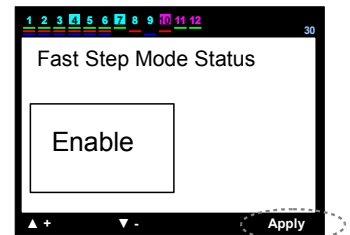

## 1 7 9 5 1 Settings – Advanced Setting Menu – Step Parameters – Continuous Step Power Detecting

This is the section in which the continuous internalization of step power is activated or de-activated. In case “Activated” is selected, the device checks the step power at each step activating and de-activating operation. In case of a change in power, then the device determine it and start to use this value. If the last value of the capacitor is decreased by 50% than the power value of the initial internalization, the device warns the user about the decrease in power of capacitor. It continues to make compensation with the value internalized finally. In case “Off” is selected, the device can only internalize the capacitor powers on the first commissioning. It determines the change, but continues to compensation with the values of initial internalization.

P.S.: It can be necessary to disable the function of step power Internalization in some plants (especially, the plants in which the loads are changing very quickly).

The required status for function is selected by using the up and down keys. Press “Apply” key in order to take this parameter into memory. “Save changes” message will appear on the screen. When “Okay” key is pressed, the value is taken into memory.

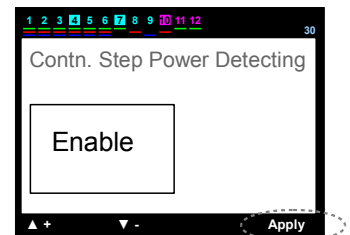

## 1 7 9 5 2 Settings – Advanced Setting Menu – Step parameters – Constant Step Function

This is the section in which the constant step function is activated or de-activated. First step switch on and stay at this position if this function is enable. This function is only used in activating constant capacitor to meet the loss of transformers in the counters measure the medium voltage. This capacitor must be connected ahead from the current transformers. Using the step of the device for constant capacitor is not recommended actually. Much more steps are required for compensation.

Consequently, constant capacitor can be connected to switch input with a on-off switch. In case “Off” is selected, the device starts to use this step.

The required status for function is selected by using the up and down keys. Press “Apply” key in order to take this parameter into memory. “Save changes” message will appear on the screen. When “Okay” key is pressed, the value is taken into memory.

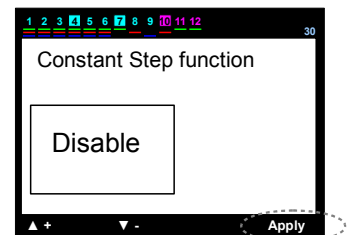

## 1 7 9 5 3 Settings – Advanced Setting Menu – Step Parameters – Step Sync. Time Sharing

This is the section of activating or de-activating the simultaneous use of levels in the same power. In case “Activated” is selected, device tries to make the used hours of capacitors in the same power equal.

The required status for function is selected by using the up and down keys. Press “Apply” key in order to take this parameter into memory. “Save changes” message will appear on the screen. When “Okay” key is pressed, the value is taken into memory.

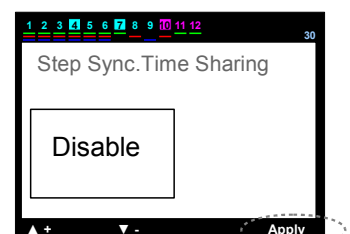

This is the section in which the step powers are entered. The device directs the user with subcommand display continuously. It is moved on the step of which the power is required to be entered by using the up and down keys. In the meantime, that line are in red colour. Select key is pressed. The selected step number comes to screen. The selection of triple-phase or single-phase of capacitor or reactor should be made on this screen.

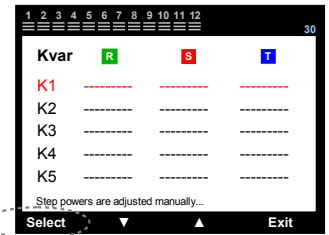

The position of red frame changes when up and down keys are used. In case the reactive load on the step is triple-phase, the frame is moved on triple-phase and "Select" key is pressed. Triple-phase option becomes red in this case. If up or down direction key is pressed, the red frame moves to total value digit. The "Select" key is pressed and a blue underline appears on the last digit inside of the frame. The value is setup by using the up and down keys starting from the digit where the blue line is. Then, left key is pressed and the blue underline moves next to the left digit. All the values are entered in the same way by using up and down keys. The "Apply" key is pressed to take them into memory. The sub-command screen changes and "Okay", then "Exit" key is pressed. "Save Changes" will appear on the screen. When "Okay" key is pressed, the value is taken into memory.

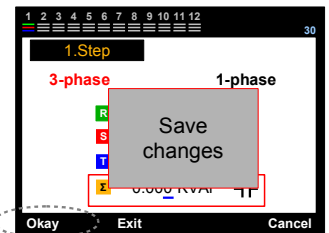
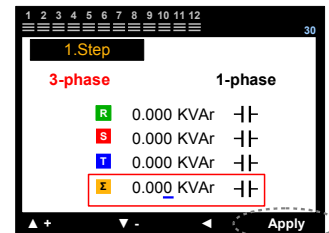
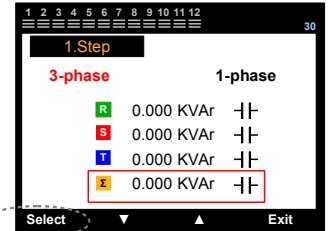

If the reactive load on the step is single-phase, frame is moved onto single-phase and "Select" key is pressed. Single-phase option becomes red in this case. In case of pressing up or down direction key is pressed, the red frame moves on the lines of R, S and T-phases including total value. In case of which phase the reactive load on the step is connected to, "Select" key is pressed during on that line. Entering the value and taking it into memory is the same as described above.

P.S.: Moving the blue underline to the digit on which the sign is by using the left key, the sign can be changed by pressing upwards key. (+) represents the reactor, (-) represents the capacitor.

This is the section in which the step parameters are deleted one by one, or all. In case the reactive load is changed in any step, the power of that step must be deleted to let the device internalize the the power of new step. The device forwards the user continuously by sub-command screen. Moving onto the step of which power required to be deleted, the up or down key is pressed. The line is in red colour in the meantime. In case of deleting only that step, "Delete" key is pressed; in case of deleting all steps (if a device used in somewhere else is connected to a new plant), "Delete All" key is pressed.

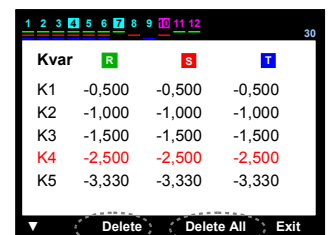

If "Delete" key is pressed, "Step Delete?" warning appears on the screen. When "Okay" key is pressed, the power of that step would be deleted. The device will automatically try to internalize the power of that step again. You can exit the menu by "Exit" key. In case "Delete All?" key is pressed, "Steps Delete?" warning appears on the screen. When "Okay" key is pressed, the power of all steps would be deleted. The device will automatically try to internalize the power of that step again. You can exit the menu by "Exit" key.

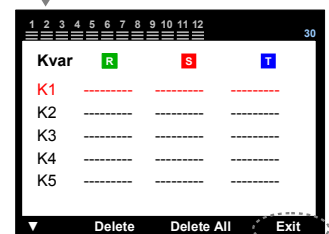
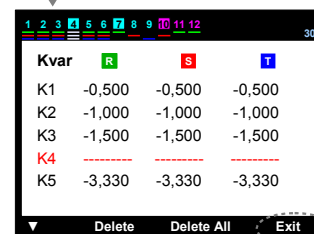
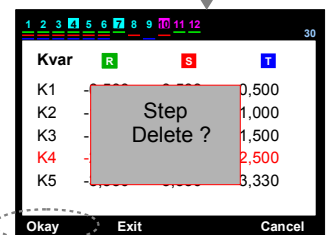
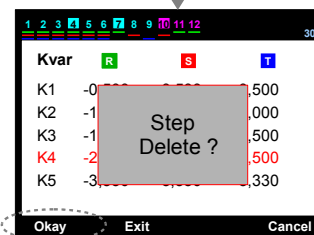

**1 7 9 5 6** Settings – Advanced Setting Menu – Step Parameters – Step Change Control

It's a useful function in terms of warning the user. First, it's better to clarify some definitions step alteration control page:

**Old value** : The first internalized power of step.

**New value**: The power altered minimum  $\pm 15\%$  with respect to the past value.

This page has been designed to identify and enter the real value of steps whose powers are not internalized, even though the powers are altered over time or replaced with the past one by the user.

In case the new value of any step is altered  $\pm 50\%$  with respect to the first value, the device warns the user as "Change in the power of capacitor". If the capacitor in which alert is given has really altered, then the new value should be loaded instead of the past one. The alteration in step power appears on the screen as a warning

In case internalization of step power is activated, the device controls the capacitor power at every step activation and de-activation process. In case of a change in the power, the device determines it and continues to compensate with the final value internalized. If "Off" is selected, the device internalizes capacitor powers only at the first activation. It determines the alteration, however continues the compensation with the first internalized values.

The device directs the user with sub-command screen continuously. The red frame is moved on the step whose power decreased (box in blue colour) by using up and down keys and "Select" key is pressed.

Sub-command screen is altered. In case of which value will be used, past or new value key is pressed and then load key is pressed. "Load selected value to step?" question appears on the screen. If "Yes" key is pressed, load will be completed.

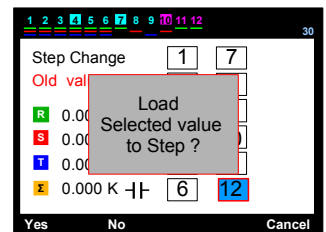
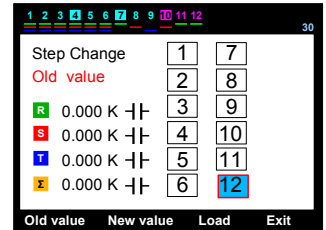
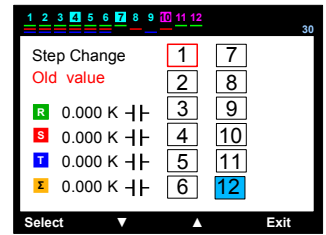

**1 7 9 6 6** Settings – Improved Setup Menu – Alert & Protection

This is the section in which the alerts are set and the value of protection parameters are entered. It consists of nested menus. You can move between the parameters which generate the menu by direction keys, and can enter the next sub-menu or into the parameter by pressing "Select" key on the sub-command screen.



The device directs the user with sub-command screen continuously. In case of entering into the parameter, the commands on the sub-screen are altered as shown on the right side. In this case blue line appears under the first digit of the parameter. The value is altered by using the up and down key starting from the digit where the blue line is. Then left key is pressed and the blue underline moves next to the left digit. All values are entered in the same way by using up and downkeys. "Select" key is pressed to take them into the memory.



"Save changes?" message will appear on the screen. Pressing "Okay" key, the value is taken into the memory.



**1 7 9 6 1** Settings – Advanced Setting Menu – Alarm & Protection – Alarm Control

This is the section in which the activation or de-activation process of alerts are performed.

**1 7 9 6 1 1** Phase alarms

- Over voltage
- Under voltage
- Over current
- Over compensation
- Under compensation
- No phase
- THD on voltage
- HD on voltage
- THD on current
- HD on current

**1 7 9 6 1 2** General Alarms

- 1st Connector Error
- 2st Connector Error
- Total over compensation
- Total under compensation
- System Error
- Over temperature
- Voltage connection
- Step Change
- Step Zero
- Modbus security Error

**1 7 9 6 1 1 1** Phase Alarms – Over Voltage (enable)

---

In case of over voltage during the activation of alert, alert is given and device warns the user.  
In this case;  
- capacitors and devices in the system may be damaged.  
- “Voltage protection activated” may be preferred in the step protection function (Chapter 179642)

**1 7 9 6 1 1 2** Phase Alarms – Under Voltage (enable)

---

In case of under voltage during the activation of alert, alert is given and device warns the user.  
In this case;  
- capacitors and devices in the system may be damaged or may not be operated properly.  
- “Voltage protection activated” may be preferred in the step protection function (Chapter 179642)

**1 7 9 6 1 1 3** Phase Alarms – Over Current (enable)

---

In case over current is drawn from the system during the activation of alert, alert is given and device warns the user. In this case;  
- Inputs of the device may be damaged any moment. This case is out of warranty.  
- Please stop the system and replace the current transformers with the larger ones.

**1 7 9 6 1 1 4** Phase Alarms – Over Compensation (enable)

---

In case the system falls into over compensation in any phase during the activation of alert, device warns the user. In this case;  
- Review the capacitor power distribution in the steps, especially in the phase where the alert is given.  
- Please allow less powerful capacitors which can reach buffer power values.

**1 7 9 6 1 1 5** Phase Alarms – Under Compensation (enable)

---

In case the system falls into under compensation in any phase during the activation of alert, device warns the user.  
In this case;  
- Review the capacitor power distribution in the steps, especially in the phase where the alert is given.  
- Please insert the capacitors which the phase or the phases need.

**1 7 9 6 1 1 6** Phase Alarms – No Phase (enable)

---

In case any phase in the system cut down during the activation of alert, device warns the user.  
In this case;  
- At least one of the phases is not in the system..  
- Measure the voltage at the voltage input terminals, control the terminals. You should read 220V between phase-neutral.

**1 7 9 6 1 1 7** Phase Alarms – THD on Voltage (enable)

---

In case total harmonic failure in the phase voltage exceeds the set value during the activation of alert, device warns the user.  
In this case;  
- You should install harmonic filter to protect your devices.

**1 7 9 6 1 1 8** Phase Alarms – HD on Voltage (enable)

---

In case the failure of any harmonics between 3...31 in the phase voltage exceeds the set value during the activation of alert, device warns the user.  
In this case;  
- You should install harmonic filter to protect your devices.

**1 7 9 6 1 1 9** Phase Alarms – THD on Current (enable)

---

In case total harmonic failure in the phase of system exceeds the set value during the activation of alert, device warns the user.  
In this case;  
- You should install harmonic filter to protect your devices.

**1 7 9 6 1 1 10** Phase Alarms – HD on Current (enable)

---

In case the failure of any harmonics between 3...31 in the phase voltage exceeds the set value during the activation of alert, device warns the user.  
In this case;  
- You should install harmonic filter to protect your devices.

**1 7 9 6 1 2 1** General Alarms – 1. connector failure (K1...K6) (enable)

---

In case of this alarm;

- (C1) common phase input may not be connected.
- The fuse of (C1) common phase input may be blown out.
- Compensation connection may be made prior to current transformers.
- Removing the failure, steps internalized zero should be internalized again.

**1 7 9 6 1 2 2** General Alarms – 2. connector failure (K7...K12) (enable)

---

In case of this alarm;

- (C2) common phase input may not be connected.
- The fuse of (C2) common phase input may be blown out.
- Compensation connection may be made prior to current transformers.
- Removing the failure, steps internalized zero should be internalized again.

**1 7 9 6 1 2 4** General Alarms – Total Over Compensation (enable)

---

In case of this alarm ;

- The system may be kept in penalty.
- Review the capacitor power distribution in the steps.
- Please allow less powerful capacitors which can reach buffer values.

**1 7 9 6 1 2 5** General Alarms – Total Under Compensation (enable)

---

In case of this alarm ;

- The system may be kept in penalty.
- Review the capacitor power selection in the steps.
- Please insert the capacitors which the phase or the phases need.

**1 7 9 6 1 2 6** General Alarms – System Failure (enable)

---

In case of this alarm;

- (C1,C2) common phase inputs may not be connected.
- The fuse of (C1,C2) common phase inputs may be blown out.
- The fuses in the power line of capacitors may be blown out.
- Removing the failure, steps internalized zero should be internalized again.

**1 7 9 6 1 2 7** General Alarms – Over Temperature (enable)

---

In case of this alarm;

- The temperature in the board exceeds the value setted.
- Please empower the panel cooling.
- “Temperature protection enable” may be preferred in the step protection function (Chapter 179641)

**1 7 9 6 1 2 8** General Alarms – Voltage Connection Failure (enable)

---

In case of this alarm;

- R and S phases may shortcircuit to each other, control the connections.
- S and T phases may shortcircuit to each other, control the connections.
- R and T phases may shortcircuit to each other, control the connections.
- Any of R, S, T phase may be connected to Neutral, control the connections.

**1 7 9 6 1 2 9** General Alarms – Step Change (enable)

---

In case of this alarm;

- The old capacitor may be replaced with the new one, but power value is not entered, or the power of capacitor may be decreased 50%.

**1 7 9 6 1 2 10** General Alarms – Step Zero (enable)

---

In case of this alarm;

- The fuses in the power line of capacitors may be blown out or contactor may be damaged.
- Removing the failure, steps internalized zero should be internalized again.

**1 7 9 6 1 2 11** General Alarms – Modbus Firewall (enable)

---

In case of this alarm;

- This means unauthorized access from the outside. Change the password of modbus read-write of the device periodically and prefer to encode read-write different.

This is the section in which the alarm setup values are entered.

This is the section in which the value of over voltage are entered. You may enter a value between 230 and 270 Volts. The value is setup to the required value by using the up and down key starting from the digit where the blue line is. Then left key is pressed and the blue underline moves next to the left digit. All values are entered in the same way by using up and downkeys. “Select” key is pressed to take them into the memory.

“Save changes?” message will appear on the screen. Pressing “Okay” key, the value is taken into the memory.

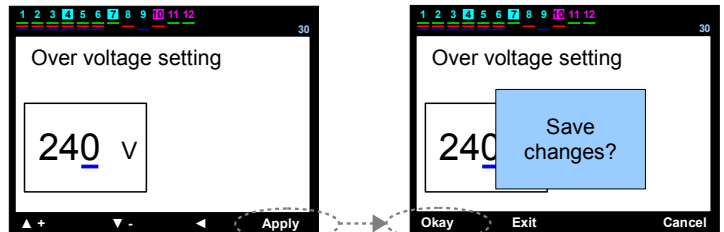

In case voltage protection is activated in the level protection function (Chapter 179642), all levels are de-activated one by one to protect the capacitors when over voltage setup value is exceeded.

This is the section in which the value of under voltage are entered. You may enter a value between 170 and 210 Volts. The value is setup to the required value by using the up and down key starting from the digit where the blue line is. Then left key is pressed and the blue underline moves next to the left digit. All values are entered in the same way by using up and downkeys.

“Select” key is pressed to take them into the memory.

“Save changes?” message will appear on the screen. Pressing “Okay” key, the value is taken into the memory.

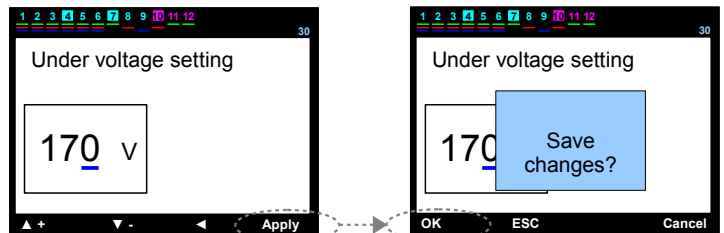

In case voltage protection is activated in the step protection function (Chapter 179642), all steps are de-activated one by one to protect the capacitors when under voltage setup value is exceeded.

The contactors are in difficulty to stay drawn especially under a certain voltage and, therefore the capacitor as well as contactor are exposed to operate in undesirable overload and arc. For this reason, activating voltage protection function is recommended.

This is the section in which the value of over temperature are entered. You may enter a value between 5 ile 85 °C. The value is setup to the required value by using the up and down key starting from the digit where the blue line is. Then left key is pressed and the blue underline moves next to the left digit. All values are entered in the same way by using up and downkeys.

“Select” key is pressed to take them into the memory.

“Save changes?” message will appear on the screen. Pressing “Okay” key, the value is taken into the memory.

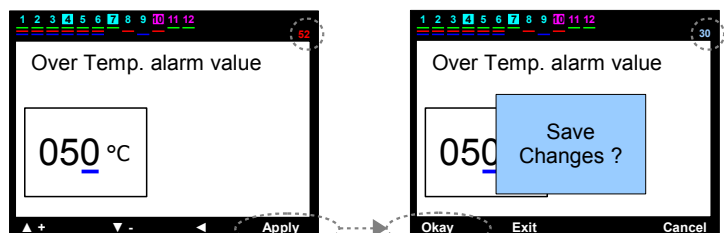

In case the temperature exceeds the setup value, the value displayed in light blue color becomes red on the upper right of screen.



In case temperature protection is activated in the step protection function (Chapter 179642), all steps are de-activated one by one to protect the capacitors when over temperature setup value is exceeded.

**1 7 9 6 2 4** Alarm Setting Values – THD Voltage Setting (% 1 – 100)

This is the section in which total harmonic distortion value (THDV) are entered for voltage. You may enter a value between 1% and 100%. The value is setup to the required value by using the up and down key starting from the digit where the blue line is. Then left key is pressed and the blue underline moves next to the left digit. All values are entered in the same way by using up and downkeys. “Select” key is pressed to take them into the memory. “Save changes?” message will appear on the screen. Pressing “Okay” key, the value is taken into the memory.

 In case harmonic protection is activated in the step protection function (Chapter 179643), all steps are de-activated one by one to protect the capacitors when THDV setup value is exceeded.

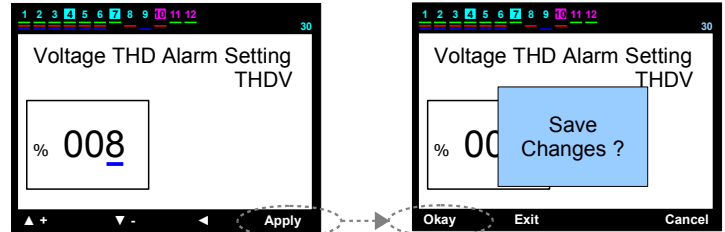

**1 7 9 6 2 5** Alarm Setting Values – HD Voltage Setting (% 1 – 100)

This is the section in which harmonic distortion value (HDV) are entered for voltage. You may enter a value between 1% and 100%. The value is setup to the required value by using the up and down key starting from the digit where the blue line is. Then left key is pressed and the blue underline moves next to the left digit. All values are entered in the same way by using up and downkeys. “Select” key is pressed to take them into the memory. “Save changes?” message will appear on the screen. Pressing “Okay” key, the value is taken into the memory.

 In case harmonic protection is activated in the step protection function (Chapter 179643), all steps are de-activated one by one to protect the capacitors when HDV setup value is exceeded.

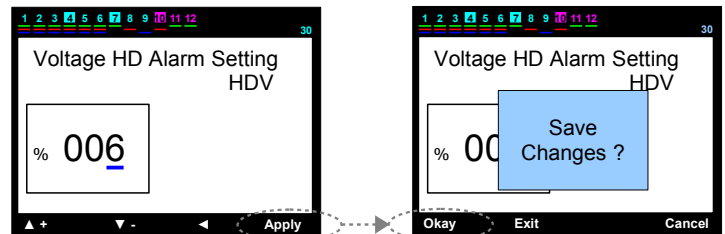

**1 7 9 6 2 6** Alarm Setting Values – THD Current Setting (% 1 – 100)

This is the section in which total harmonic distortion value (THDI) are entered for current. You may enter a value between 1% and 100%. The value is setup to the required value by using the up and down key starting from the digit where the blue line is. Then left key is pressed and the blue underline moves next to the left digit. All values are entered in the same way by using up and downkeys. “Select” key is pressed to take them into the memory. “Save changes?” message will appear on the screen. Pressing “Okay” key, the value is taken into the memory.

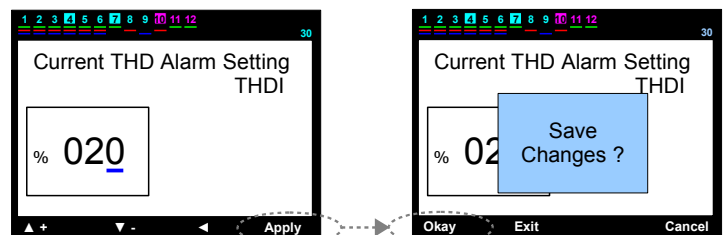

**1 7 9 6 2 7** Alarm Setting Values – HD Current Setting (% 1 – 100)

This is the section in which harmonic distortion value (HDI) are entered for current. You may enter a value between 1% and 100%. The value is setup to the required value by using the up and down key starting from the digit where the blue line is. Then left key is pressed and the blue underline moves next to the left digit. All values are entered in the same way by using up and downkeys. “Select” key is pressed to take them into the memory. “Save changes?” message will appear on the screen. Pressing “Okay” key, the value is taken into the memory.

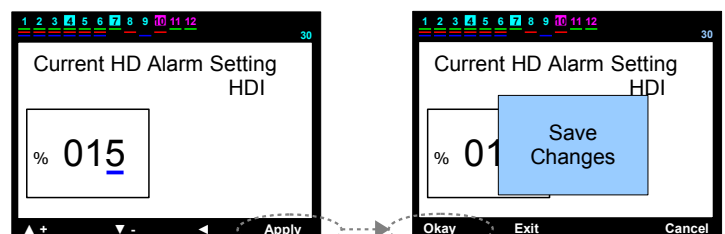



### Setting – Advanced Setting Menu – Alarm & Protection – Fan Settings

This is section in which the setup values of fan inputs are entered.



### Fan Settings – Fan Temperature Value (5 – 85 °C)

This is the section in which fan output activation value is entered. You may enter a value between 5 and 85 °C. The value is setup to the required value by using the up and down key starting from the digit where the blue line is. Then left key is pressed and the blue underline moves next to the left digit. All values are entered in the same way by using up and downkeys. “Select” key is pressed to take them into the memory.

“Save changes?” message will appear on the screen. Pressing “Okay” key, the value is taken into the memory.

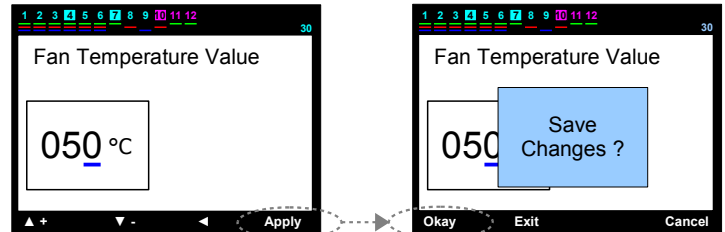

### Fan Settings – Fan Output

The required condition is selected for function by using up or down keys. “Select” key is pressed to take them into the memory. “Save changes?” message will appear on the screen. Pressing “Okay” key, the value is taken into the memory.

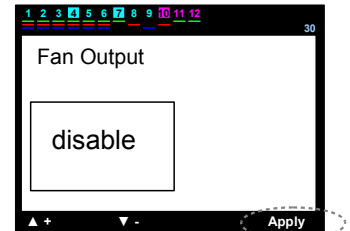

### Setting – Advanced Setting Menu – Alarm & Protection – Step Protection Function

De-activation of the capacitors is recommended to protect them against temperature, voltage and harmonics. This is the section in which protection is permitted.

P.S.: In case the current connector moves out or there is a connection failure at the voltage inputs, protection is activated automatically and de-activates the steps one by one.



### Step Protection Function – Temperature Protection

This is the section in which the temperature protection function is activated or de-activated. The over temperature alarm should also be activated to operate the protection function (Chapter 1.7.9.6.1.2.7).

The required condition is selected for function by using up or down keys. “Select” key is pressed to take them into the memory. “Save changes?” message will appear on the screen. Pressing “Okay” key, the value is taken into the memory.

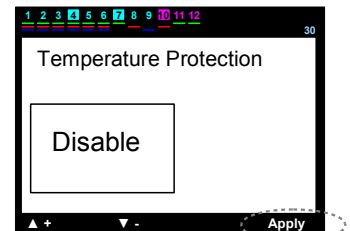

### Step Protection Function – Voltage Protection

This is the section in which the voltage protection function is activated or de-activated. The voltage alarms should also be activated to operate the protection function (over voltage, under voltage, no phase).

The required condition is selected for function by using up or down keys. “Select” key is pressed to take them into the memory. “Save changes?” message will appear on the screen. Pressing “Okay” key, the value is taken into the memory.

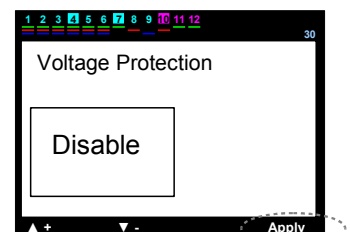



**1 7 9 6 4 3** Step Protection Function – Harmonics Protection

This is the section in which the protection function is activated or deactivated against voltage harmonics. Voltage harmonic alarms (THDV and/or HDV) should be activated in order to operate protection function.

The required condition is selected for function by using up or down keys. “Select” key is pressed to take them into the memory. “Save changes?” message will appear on the screen. Pressing “OK” key, the value is taken into the memory.

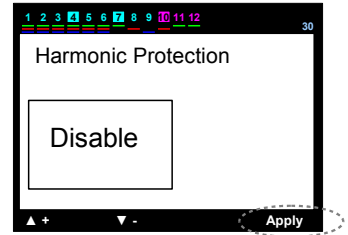

**1 7 9 7** Setting – Advanced Setting Menu – Password Settings

**1 7 9 7 1** Setting – Advanced Setting Menu – Password Settings – Password Enable/Disable

This is the section in which the use of device is activated or deactivated with password. Initial password is “0000”. In case the user changes the password, old password is valid even if returned to the factory settings. In case of forgetting the password, our technical support team should be called.

The required condition is selected for function by using up or down keys. “Select” key is pressed to take them into the memory. “Save changes?” message will appear on the screen. Pressing “Okay” key, the value is taken into the memory.

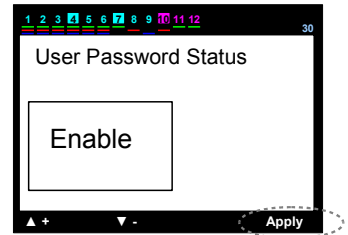

**1 7 9 7 2** Setting – Advanced Setting Menu – Password Settings – Change Password

This is the section in which password is changed.

First, old password must be entered correctly.

Number value of the digit under which blue line is, is entered by using upwards key. You can move to the next digit by the right key. When the values of all digits are entered in the same way, “Okay” key is pressed.

In case the old password is entered correctly, the new password page is displayed in order to let the user change password.

New password is entered two times in the same way. In case two passwords are the same, “Password Correct” message displays on the screen.

When “Okay” key is pressed, the new password is taken into memory.

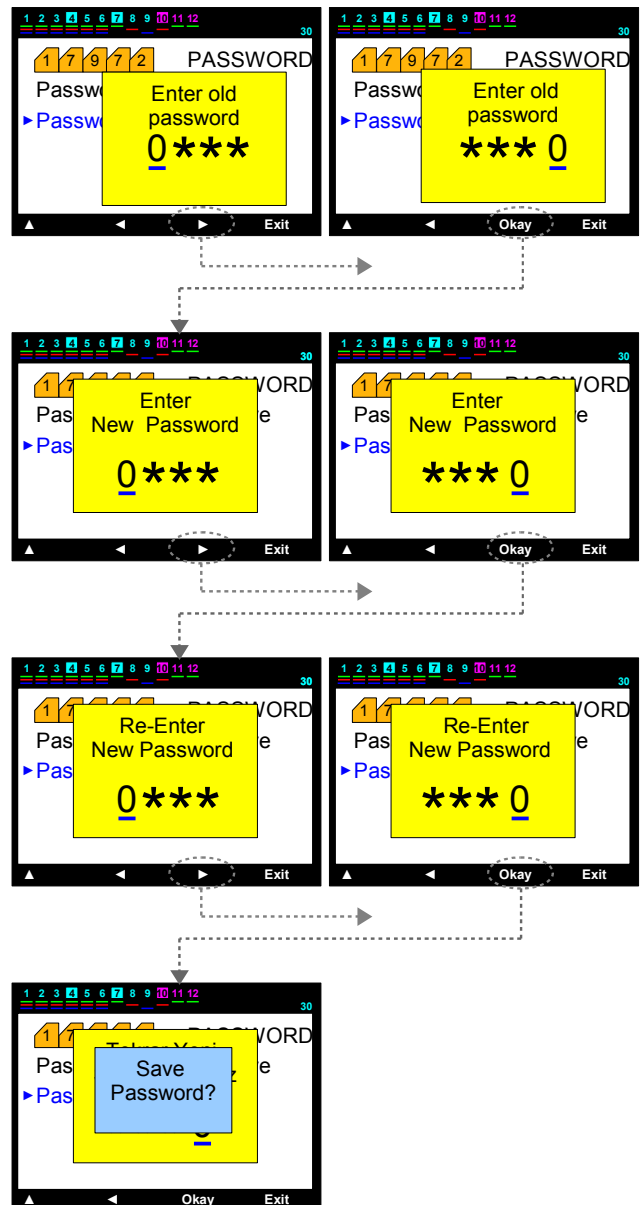

**1 7 9 8** Setting – Advanced Setting Menu – Generator Parameters

**1 7 9 8 1** Setting – Advanced Setting Menu – Generator Parameters – Target TanΦ<sub>2</sub>-CosΦ<sub>2</sub>

This is the section in which % value (TanΦ<sub>2</sub>) required for compensation is entered when generator is activated. CosΦ<sub>2</sub> value corresponds to % value is displayed on the right side automatically. The value is setup to the required value by using the up and down key starting from the digit where the blue line is. Then left key is pressed and the blue underline moves next to the left digit. All values are entered in the same way by using up and downkeys. Moving the blue underline to the digit on which the sign is by using the left key, the sign can be changed by pressing upwards key. (+) represents the inductive, (-) represents the capacitive area.

“Select” key is pressed to take the value into the memory. “Save changes?” message will be displayed on the screen. Pressing “Okay” key, the value is taken into the memory.

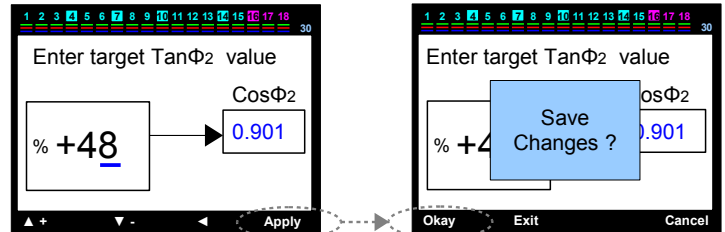

**1 7 9 8 2** Setting – Advanced Setting Menu – Generator Parameters – Gen. Input Enable/Disable

This is the section in which the generator input is activated or de-activated. In case activated is selected, the device makes compensation according to cosΦ<sub>2</sub> when generator is activated . The target is to use the power of generator maximum. The required condition is selected for function by using up or down keys. “Select” key is pressed to take them into the memory. “Save changes?” message will appear on the screen. Pressing “Okay” key, the value is taken into the memory.

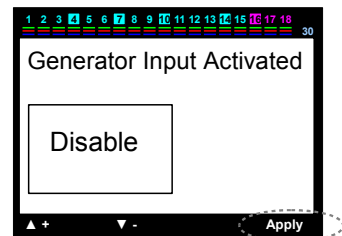

- ⚠ CosΦ<sub>2</sub> value is not selected so big. In case the load rises suddenly when the generator is activated, the voltage increases and electronic devices may be damaged.
- ⚠ When network is on, you should take care for making connection as to avoid voltage to reach generator input. Otherwise, the device may be in penalty since it makes the compensation according to cosΦ<sub>2</sub> during the network is on.

**1 7 9 9** Setting – Advanced Setting Menu – MODBUS RTU Settings

**1 7 9 9 1** Setting – Advanced Setting Menu – MODBUS RTU Settings – Data Write Protection

This is the section which is used to give writing allowance to the device parameters when connection is made externally via MODBUS RTU.

The required condition is selected for function by using up or down keys. “Select” key is pressed to take them into the memory. “Save changes?” message will appear on the screen. Pressing “OK” key, the value is taken into the memory.

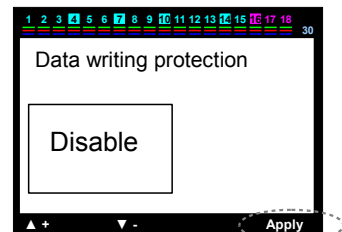

**1 7 9 9 2** Setting – Advanced Setting Menu – MODBUS RTU Settings – Data Read Protection

This is the section which is used to give reading allowance to the device parameters and data when connection is made externally via MODBUS RTU.

The required condition is selected for function by using up or down keys. “Select” key is pressed to take them into the memory. “Save changes?” message will appear on the screen. Pressing “OK” key, the value is taken into the memory.

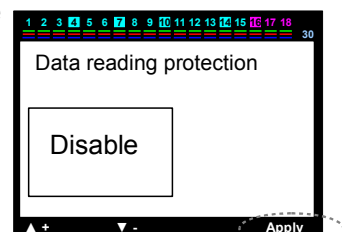

**1 7 9 9 3** Setting – Advanced Setting Menu – MODBUS RTU Settings – Data Write Password

The password should be entered to write data. This is the section in which the password is entered. The value is setup to the required value by using the up and down key starting from the digit where the blue line is. Then left key is pressed and the blue underline moves next to the left digit. All values are entered in the same way by using up and downkeys. “Select” key is pressed to take them into the memory. “Save changes?” message will appear on the screen. Pressing “Okay” key, the value is taken into the memory. P.S.: The security increases when giving different passwords for writing and reading data.

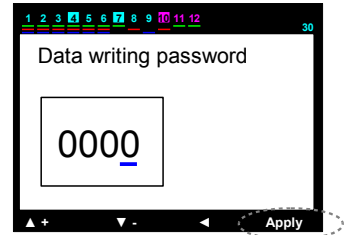

**1 7 9 9 4** Setting – Advanced Setting Menu – MODBUS RTU Settings – Data Read Password

The password should be entered to read data. This is the section in which the password is entered. The value is setup to the required value by using the up and down key starting from the digit where the blue line is. Then left key is pressed and the blue underline moves next to the left digit. All values are entered in the same way by using up and downkeys. “Select” key is pressed to take them into the memory. “Save changes?” message will appear on the screen. Pressing “Okay” key, the value is taken into the memory. P.S.: The security increases when giving different passwords for writing and reading data.

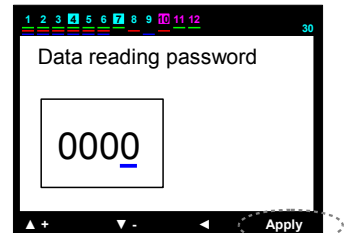

**1 7 9 9 5** Setting – Advanced Setting Menu – MODBUS RTU Settings – Port Settings



This is the section in which Modbus port setup is entered.

**Baud rate:** It can be selected as 2400,4800,9600,19200,28800,38400,57600 or 115200.

**Stop Bits :** It can be selected as (0.5) , (1) , (1.5) or (2).

**Parity** : no , even , odd

Up or down key is used for the entry of above parameters.

“Select” key is pressed to take them into the memory. “Save changes?” message will appear on the screen. Pressing “Okay” key, the value is taken into the memory.

**Device No :** 001 .....255

The value is setup to the required value by using the up and down key starting from the digit where the blue line is. Then left key is pressed and the blue underline moves next to the left digit. All values are entered in the same way by using up and downkeys. “Select” key is pressed to take them into the memory. “Save changes?” message will appear on the screen. Pressing “Okay” key, the value is taken into the memory.

## 1 8 Factory Defaults

This is the section which is used to restore factory default values to the device.

### Factory Default Values :

Target TanΦ(cosΦ)	: % 0
Switch on (Decharge) Time	: 20 sec
Switch off Time	: 15 sec
Switch min. Time	: 10 sec
Inductive Penalty Limit (%)	: % 15
Capacitive Penalty Limit (%)	: % 10
Current Transformer (Primary) Value	: 5 / 5 A
Number of steps	: 12
ΔT on Transition(Delay) Time	: 0 sec
ΔT off Transition(Delay) Time	: 0 sec
Continuous Current Flow Direction Detection	: enable
Fast Step Mode	: enable
Continuous Step Power Detection	: enable
Constant Step Function	: disable
Step Synch. Time Sharing	: disable
Phase Alarms – Over Voltage	: enable
Phase Alarms – Under Voltage	: enable
Phase Alarms – Over Current	: enable
Phase Alarms – Over Compensation	: enable
Phase Alarms – Under Compensation	: enable
Phase Alarms – No Phase	: enable
Phase Alarms – THD on Voltage	: enable
Phase Alarms – HD on Voltage	: enable
Phase Alarms – THD on Current	: enable
Phase Alarms – HD on Current	: enable
General Alarms – 1. connector failure	: enable
General Alarms – 2. connector failure	: enable
General Alarms – Total Over Compensation	: enable
General Alarms – Total Under Compensation	: enable
General Alarms – System Failure	: enable
General Alarms – Over Temperature	: enable
General Alarms – Voltage Connection Failure	: enable
General Alarms – Step Change	: enable
General Alarms – Step Zero	: enable
General Alarms – Modbus Security Failure	: enable
Alarm Setting Values – Over Voltage	: 250V
Alarm Setting Values – Under Voltage	: 180V
Alarm Setting Values – Over Temperature	: 70 °C
Alarm Setting Values – THD Voltage	: % 10
Alarm Setting Values – HD Voltage	: % 10
Alarm Setting Values – THD Current	: % 30
Alarm Setting Values – HD Current	: % 30
Fan Settings – Fan Temperature Value	: 50 °C
Fan Settings – Fan Output	: disable
Level Protection Function–Temperature Protection	: disable
Level Protection Function – Voltage Protection	: disable
Level Protection Function – Harmonic Protection	: disable
Password Procedure – Password Settings	: enable
Password Procedure – Default Password	: 0000 (refer to PS1)
Generator Parameters – Target TanΦ2-CosΦ2	: % 48 - 0,901
Generator Parameters–Generator Input	: disable
MODBUS RTU Setup – Data Write Protection	: disable
MODBUS RTU Setup – Data Read Protection	: disable
MODBUS RTU Setup – Data Write Password	: 0000 (refer to PS2)
MODBUS RTU Setup – Data Read Password	: 0000 (refer to PS2)
MODBUS Port Setup – Baud Rate	: 9600
MODBUS Port Setup – Stop Bits	: 1
MODBUS Port Setup – Parity	: No
MODBUS Port Setup – Device No	: 1

**PS 1** : User password is defined as “0000” at first. However, after password is changed, password will not change even if returned to the factory settings. The last password that the user entered is valid.

**PS 2** : It is different than the user password of the device. However it can be entered into the device manually, it can not be changed by remote access. In case of restoring factory settings, “0000” is appointed to modbus password.

**PS 3** : In case of restoring factory settings, the current directions, capacitor powers, energies and counter indexes that the device internalized before, are reset.

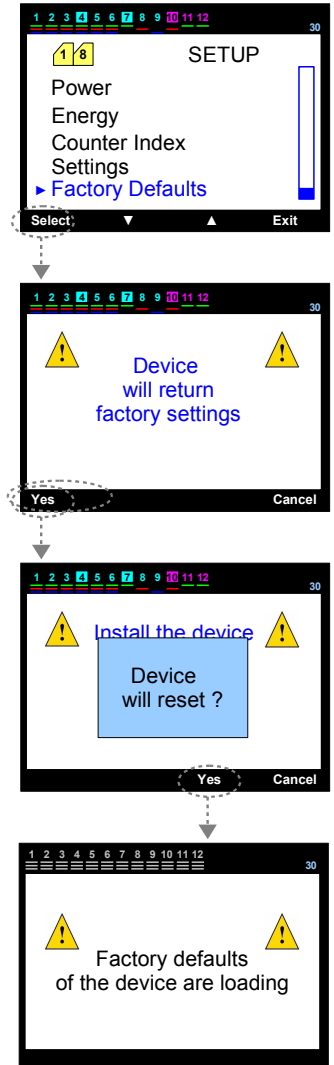

 In case of restoring factory settings, all the changes that the user made, except password, will be cancelled.

## Technical Info

Operating Voltage (Un)	: (Phase-Neutral ) 220Vac ; (Phase-Phase) 380 Vac
Operating Range	: (0,8-1,1) x Un
Operating Frequency	: 50/60 Hz
Supply Power Consumption	: < 10VA
Power Consumption of Measurement Inputs	: < 1VA
Contact Current	: Max.3A/240 Vac
Current Measurement Range	: (as secondary current of current transformer) 0,01 - 6 Amp AC
Display Range	: (Power Factor) 0,000 - 1,000 ind.and cap.
Mimimum Current Measurement Value	: 10 mA
Measurement Accuracy	: %1±1 digit
Current Transformer Ratio	: 5/5.....10000/5 A
Display	: 3,2" coloured LCD
<b>RS485</b>	
Baud rate	: 2400,4800,9600,19200,28800,38400,57600,115200
Stop Bits	: (0.5) , (1) , (1.5) or (2)
Parity	: no , even , odd
Device No	: 1 .....255
Device Protection Class	: IP 20
Terminal Protection Class	: IP 00
Environment Temperature	: - 5 °C .... + 50 °C
Humidity	: %15 ..... %95 (without condensation)
Device Standart	: EN 55011: 2007 + A2 : 2007 EN 61326 : 2006 EN 61000-3-2 : 2006 EN 61000-3-3 : 1995 + A1 : 2001 + A2 : 2005 EN 61010-1 : 2001
Connection Type	: On the front cover of the panel
Dimensions	: 144x144x45 mm

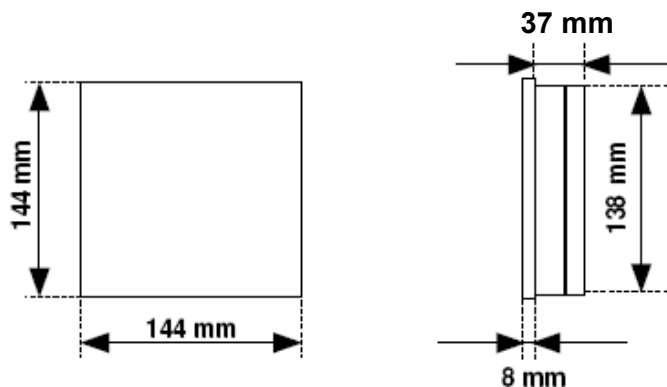

## Installation

- 1- An outlet in square form by 140 mm x 140 mm will be made on the panel where the assembly of the device will be made.
- 2- Prior to the assembly of the device, remove the apparatus of the panel.
- 3- Insert the device from the front window drilled at the panel.
- 4- Fix the device to the panel by using panel holding apparatus at the back of the device.

**!** Make the assembly as to leave a 50 mm space between the wall and the back of the device for ventilation.

### PANEL OUTLET MEASUREMENT

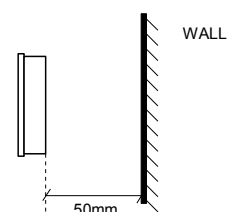
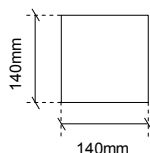

## APPENDIX-A

### CALCULATION CHART ACCORDING TO CAPACITOR CONNECTION FORMAT



Capacitor Powers	3 Phase Connection (Q/3)	Phase-Neutral Connection (Q/6)	Phase-Neutral bridged Connection (2*Q/9)	Phase-Phase Connection (Q/4)	Phase-Phase bridged Connection (Q/3)
<b>0,5 KVAR</b>	0,16 KVAR	0,08 KVAR	0,11 KVAR	0,12 KVAR	0,16 KVAR
<b>1 KVAR</b>	0,33 KVAR	0,16 KVAR	0,22 KVAR	0,25 KVAR	0,33 KVAR
<b>1,5 KVAR</b>	0,5 KVAR	0,25 KVAR	0,33 KVAR	0,37 KVAR	0,5 KVAR
<b>2,5 KVAR</b>	0,83 KVAR	0,41 KVAR	0,55 KVAR	0,62 KVAR	0,83 KVAR
<b>5 KVAR</b>	1,66 KVAR	0,83 KVAR	1,11 KVAR	1,25 KVAR	1,66 KVAR
<b>7,5 KVAR</b>	2,5 KVAR	1,25 KVAR	1,66 KVAR	1,87 KVAR	2,5 KVAR
<b>10 KVAR</b>	3,33 KVAR	1,66 KVAR	2,22 KVAR	2,5 KVAR	3,33 KVAR

The values given at the chart are the capacitor powers which will be entered into PR12-D12 for each phase or which PR12-D12 will display automatically when internalized by itself for each phase.