

Molded Case Circuit Breakers



For further information on 3VL according to UL, see Catalog LV 16



NEW

Direct reference to the products in the Industry Mall from the selection and ordering data tables:

Article No.
[www.siemens.com/product?Article No.](http://www.siemens.com/product?ArticleNo.)

3VA2025-5HL36-0AA0

Paper catalog:
 To get more product information enter the Web address plus Article No.

PDF catalog:
 Get more product information with just a mouse click.

3VA molded case circuit breakers NEW	
2/6	General data
2/16	3VA1 molded case circuit breakers up to 250 A, IEC
2/42	3VA2 molded case circuit breakers up to 630 A, IEC
2/68	3VA molded case circuit breakers – accessories, IEC
2/68	- Internal accessories
2/75	- Manual operators
2/80	- Motor operators
2/81	- Connection technology
2/96	- Plug-in and draw-out technology
2/101	- Residual current devices
2/104	- Communication and testing/ commissioning devices
2/110	- Locking and interlocking
2/114	- Other
3VL molded case circuit breakers up to 1600 A, IEC	
2/116	Introduction
2/122	General data
2/126	3-pole
2/150	4-pole
2/171	Options
2/175	Accessories and spare parts
3VL molded case circuit breakers up to 1600 A, according to UL 489	
2/214	Introduction
2/220	3-pole
2/236	Options
2/238	Accessories and spare parts
	General data
2/272	- Design
2/277	- Function
2/281	- Configuration
2/282	- Technical specifications
Ch.10	Busbar device adapters and device holders from 630 A to 1600 A
Ch.11	4NC current transformers
Ch. 12	3KC ATC5300 and NEW ATC3100 transfer control devices
Ch.12	Residual current devices (MRCD)

For further technical product information:

Siemens Industry Online Support:
www.siemens.com/lowvoltage/product-support

- Entry type:
- Application example
- Certificate
- Characteristic
- Download
- FAQ
- Manual
- Product note
- Software archive
- Technical data

Molded Case Circuit Breakers

3VA Molded Case Circuit Breakers

NEW

General data

Overview

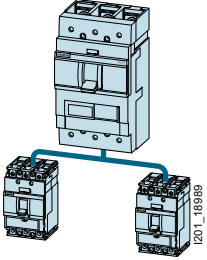
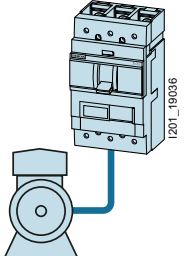
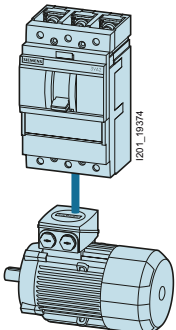
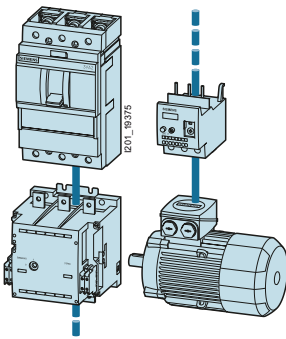
Application	Page	3VA1	3VA2	Description	Standards
Line protection					
	2/16 ... 2/37 2/42 ... 2/65	✓	✓	The trip units for line protection are designed to provide overload and short-circuit protection for: <ul style="list-style-type: none"> • Cables • Lines • Non motorized loads 	IEC/EN 60947-1, IEC/EN 60947-2
Generator protection					
	2/48 ... 2/53 2/60 ... 2/65	--	✓	The setting values of the trip units are matched to protecting generators.	IEC/EN 60947-1, IEC/EN 60947-2
Motor protection					
	2/66 ... 2/67	--	✓	The overload and short-circuit releases are designed for optimal protection and direct starting of three-phase AC squirrel-cage motors. The molded case circuit breakers for motor protection have phase-failure sensitivity and a thermal image that protects the motor against overheating. The adjustable time lag class enables users to adjust the overload release to the startup conditions of the motor to be protected.	IEC / EN 60947-1, IEC / EN 60947-2, IEC / EN 60947-4-1 IE3 ready
Protection for starter combinations (starter protection)					
	2/38 ... 2/39 2/66 ... 2/67	✓	✓	Starter combinations consist of: Molded case circuit breaker + contactor + overload relay. The molded case circuit breaker handles short-circuit protection and the isolating function. The task of the contactor is the operational switching of the feeder. The overload relay handles overload protection that can be specially matched to the motor. The molded case circuit breaker for the starter combination is therefore equipped with an adjustable and instantaneous short-circuit release.	IEC / EN 60947-1, IEC / EN 60947-2, IEC / EN 60947-4-1 IE3 ready

2

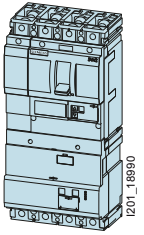
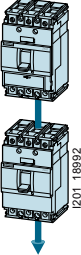
Application	Page	3VA1	3VA2	Description	Standards
Residual current protection 	2/101 ... 2/103	✓	✓	Residual current protective devices afford fault protection (formerly referred to as: protection in case of indirect contact) and supplementary protection (formerly referred to as: Protection in case of direct contact) in low-voltage systems in the event of the basic insulation failing or live parts being touched. Their task is to prevent or reduce injury to personnel or livestock, or damage to property.	IEC / EN 60947-2 (Annexes B, M)
Switch disconnectors 	2/40	✓	--	Switch disconnectors are deployed: <ul style="list-style-type: none"> • As main disconnecting means • For on/off switching • For disconnection of loads • As switch disconnectors without overload and short-circuit protection The switch disconnectors correspond to IEC / EN 60947-3.	IEC / EN 60947-1, IEC / EN 60947-3

Molded Case Circuit Breakers

3VA Molded Case Circuit Breakers

NEW

General data

Sizes

The integrated 3VA portfolio consists of two different series of molded case circuit breakers in eight different rated operational current versions (sizes).

The new 3VA molded case circuit breakers set new standards in flexibility and the variety of modular accessories available. Standardized accessories suitable for use with several sizes of circuit breaker from all the 3VA ranges help to cut costs and save time.

The new 3VA1 molded case circuit breakers are available in 1 to 4-pole versions (3VA1 160 A) or in 3 and 4-pole versions (3VA1 100 A and 250 A). The new 3VA2 molded case circuit breakers are available in 3 and 4-pole versions.

The circuit breakers are available with rated operational currents ranging from 16 A to 630 A and rated voltages up to 690 V, depending on the series and size.

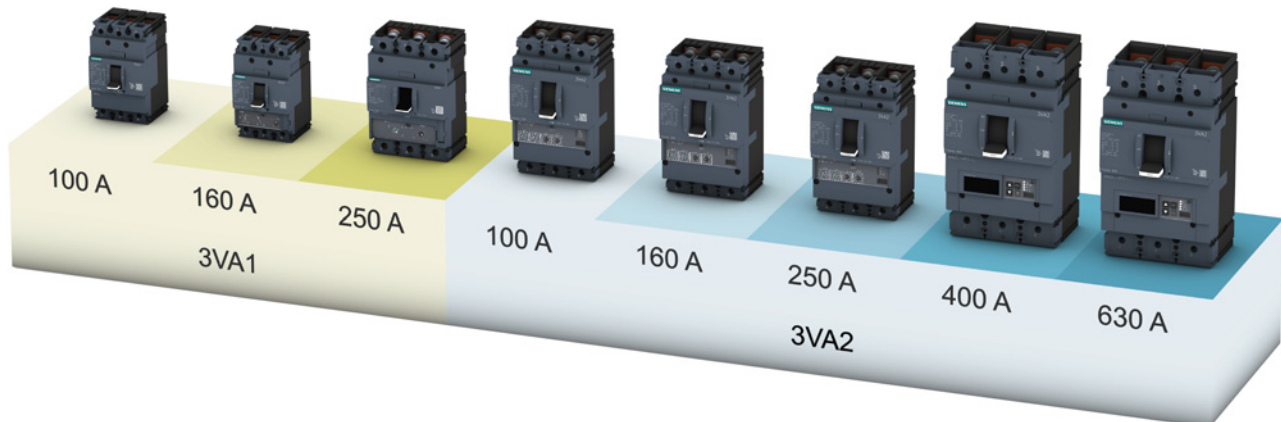

Integrated system

When it comes to operation, functionality and installation, the new 3VA series of molded case circuit breakers is a fully integrated system. This principle is embodied in the basic units and in all internal and external accessories.

The benefits offered by the internal and external accessories available for the 3VA molded case circuit breakers are:

- Standardized methods of operation
- Standardized scope of functions
- Standardized installation procedures
- Standardized accessories from 100 A ... 630 A (e.g. auxiliary switches, auxiliary releases, etc.)

3VA1 molded case circuit breakers

The new 3VA1 molded case circuit breakers reliably perform all the tasks required for line protection.

Features

The key features of the 3VA1 series are:

- Compact design
- Depending on size: 1-pole to 4-pole versions
- Depending on size: Breaking capacity of 16 kA ... 70 kA at 415 V, 3 or 4-pole breakers and 36 kA at 240 V, 1-pole breakers
- Fixed-mounted, plug-in version (depending on size)
- Thermal-magnetic trip units
- AC/DC applications
- No derating up to +50 °C
- Modular and easy-to-fit internal accessories with diverse functions
- Uniform accessories platform across all 3VA molded case circuit breakers

Compact dimensions

Thanks to a mounting depth of 70 mm and a cover size of 45 mm, the 3VA1 molded case circuit breakers of sizes 100 A, 160 A and 250 A are predestined for protecting cables and lines in the plant area, especially for the electrical installation area. For these applications, there is also a wide range of accessories available such as adapters for installation on standard mounting rails, as well as residual current devices (RCD310 (up to 160 A) and RCD510) that can be side-mounted.

Thermal-magnetic trip unit

A thermal-magnetic principle trip unit is the basic trip unit for providing overload and short-circuit protection. This has been developed for implementing economical, cost-efficient installations up to 250 A. It is suitable for use in three-phase networks, AC networks, 400 Hz applications, and with DC currents.

3VA2 molded case circuit breakers

The new 3VA2 molded case circuit breakers reliably perform all the tasks required for line protection, generator protection, motor protection and protection of starter combinations.

This series is designed for applications with increased requirements:

- Increased breaking capacity
- Very good selective protection response
- Integrated metering function
- Connection to a communication system

Features

The most important features of the 3VA2 series are:

- Compact dimensions
- 3 and 4-pole versions
- Four breaking capacity classes from 55 kA ... 150 kA
- Fixed-mounting, plug-in technology, draw-out technology
- Depending on size: Selective protection response in rated operational current interval 1 : 2.5
- Electronic Trip Units
- Retrofittable communication for ETU 5-series and 8-series
- Depending on the ETU: Integrated metering function
- AC applications
- No derating up to +50 °C
- Modular and easy-to-fit internal accessories with diverse functions
- Uniform accessories platform across all 3VA molded case circuit breakers

Compact dimensions with function expansions

In addition to its expanded functionality, the 3VA2 molded case circuit breaker also comes with compact dimensions for fixed mounting, as a plug-in version and a draw-out version.

A cover size of 70 mm for the door cutout and a complete selection of breaking capacity classes from 55 kA to 150 kA at 415 V AC provide the necessary flexibility for planning.

Despite its compact size, the circuit breaker offers the following benefits:

- Extremely high breaking capacity
- Extremely good selectivity
- Electronic trip units, versions with and without integrated metering function and optional communication interface

Selective contact system

With its contact system, the 3VA2 molded case circuit breaker is designed for fast selectivity tripping. The selective contact system ensures the following:

- Dynamic instantaneous short-circuit range
- High breaking capacity
- Selective protection response of the molded case circuit breakers in relation to each other
- Selective protection response of the molded case circuit breakers in relation to other protection devices such as downstream low-voltage fuses, etc.

Electronic Trip Units (ETUs)

The current sensor of the 3VA2 comprises an iron-cored transformer for the internal power supply and a Rogowski coil for precise current measurement. Each transformer can be optimized accordingly for its specific task. Thanks to the high accuracy of current measurement, the 3VA2 molded case circuit breaker is suitable for power/energy measurement. In addition, finer adjustment of ground fault current monitoring is possible.

The Electronic Trip Units (ETUs) provide the following protection functions:

- Overload protection L ("L" = Long-time delay)
- Short-time delayed short-circuit protection S ("S" = Short-time delay) for time-selective response in case of a short-circuit
- Instantaneous short-circuit protection I ("I" = Instantaneous)
- Protection of the neutral conductor N against overload and short-circuit ("N" = Neutral)
- Protection against residual currents to ground ("G" = Ground fault)
- ELISA:
Improved selective grading of downstream LV HRC fuses and upstream molded case circuit breakers by means of a special form of current-time characteristic

Energy management and communication

The Electronic Trip Units (ETUs) provide the following energy management and communication functions:

- Metering functions
- Communication
- Flexible, local, digital inputs and outputs via the EFB300 external function box
- Software commissioning support with powerconfig
- Testing and archiving with the TD300 and TD500 test devices (with powerconfig)

Molded Case Circuit Breakers

NEW 3VA Molded Case Circuit Breakers

General data

2



3VA20	3VA21	3VA22	3VA23	3VA24
3, 4	3, 4	3, 4	3, 4	3, 4

3VA2 molded case circuit breakers for line protection, selectivity applications

100 A	160 A	250 A	400 A	630 A
25 ... 100	25 ... 160	160 ... 250	250 ... 400	400 ... 630
690	690	690	690	690
800	800	800	800	800
8	8	8	8	8
✓	✓	✓	✓	✓
50 ... 60	50 ... 60	50 ... 60	50 ... 60	50 ... 60

M H C L				M H C L				M H C L				M H C L				M H C L			
85	110	150	200	85	110	150	200	85	110	150	200	85	110	150	On req.	85	110	150	On req.
55	85	110	150	55	85	110	150	55	85	110	150	55	85	110	On req.	55	85	110	On req.
55	85	110	150	55	85	110	150	55	85	110	150	55	85	110	On req.	55	85	110	On req.
36	55	85	100	36	55	85	100	36	55	85	100	36	55	85	On req.	36	55	85	On req.
2	2	2	24	2.5	2.5	2.5	24	3	3	3	24	5	5	5	On req.	6	6	6	On req.
--	--	--	--	--	--	--	--	--	--	--	--	--	--	--	--	--	--	--	--
--	--	--	--	--	--	--	--	--	--	--	--	--	--	--	--	--	--	--	--
--	--	--	--	--	--	--	--	--	--	--	--	--	--	--	--	--	--	--	--
--	--	--	--	--	--	--	--	--	--	--	--	--	--	--	--	--	--	--	--
85	110	150	200	85	110	150	200	85	110	150	200	85	110	150	On req.	85	110	150	On req.
55	85	110	150	55	85	110	150	55	85	110	150	55	85	110	On req.	55	85	110	On req.
55	85	110	150	55	85	110	150	55	85	110	150	55	85	110	On req.	55	85	110	On req.
36	55	85	100	36	55	85	100	36	55	85	100	36	55	85	On req.	36	55	85	On req.
2	2	2	18	2.5	2.5	2.5	18	3	3	3	18	5	5	5	On req.	6	6	6	On req.
--	--	--	--	--	--	--	--	--	--	--	--	--	--	--	--	--	--	--	--
--	--	--	--	--	--	--	--	--	--	--	--	--	--	--	--	--	--	--	--
--	--	--	--	--	--	--	--	--	--	--	--	--	--	--	--	--	--	--	--
--	--	--	--	--	--	--	--	--	--	--	--	--	--	--	--	--	--	--	--

Molded Case Circuit Breakers

3VA Molded Case Circuit Breakers

NEW

General data

2



Type		3VA10	3VA11	3VA11	3VA11	3VA12
3VA1 molded case circuit breakers for line protection, standard applications						
Service life (make-break operations)						
Mechanical		15000	15000	15000	15000	15000
Electrical	380 ... 415 V	8000	8000	8000	8000	8000
Trip units	FTFM TM210	✓	✓	✓	✓	--
	ATFM TM220	--	--	--	✓	--
	ATAM TM240	--	--	--	✓	✓
	LI ETU320	--	--	--	--	--
	LIG ETU330	--	--	--	--	--
	ELISA LI ETU340	--	--	--	--	--
	LSI ETU350	--	--	--	--	--
	LSI ETU550/ETU850	--	--	--	--	--
	LSIG ETU560/ETU860	--	--	--	--	--
3VA1 molded case circuit breakers for protecting starter combinations (standards and specifications IEC 60947-4-1 acc. to AC-1)						
Rated operational current I_n at 50 °C ambient temperature	A	--	--	--	32 ... 125	160, 200
Service life (make-break operations)						
Mechanical		15000	15000	15000	15000	15000
Electrical	380 ... 415 V	8000	8000	8000	8000	8000
Trip units	AM TM120M	--	--	--	✓	✓
	I ETU310M	--	--	--	--	--
	LSI ETU350M	--	--	--	--	--
	LSIG ETU860M	--	--	--	--	--
Switch disconnectors						
Electrical characteristics according to IEC 60947-3						
Number of poles		--	--	--	3, 4	3, 4
Rated uninterrupted current I_U at 50 °C ambient temperature	A	--	--	--	63 ... 160	250
Rated operational voltage U_e AC 50/60 Hz	V	--	--	--	690	690
Rated operational voltage U_e DC	V	--	--	--	500 (3p)/600 (4p)	500 (3p)/600 (4p)
Rated short-circuit making capacity I_{cn} with upstream circuit breaker	kA	--	--	--	70 kA at 415 V	70 kA at 415 V
Permissible rated short-time current I_{cw}	±1s kA	--	--	--	2	On request
Dimensions						
		mm	76.2 (3p)/101.6 (4p)	25.4	50.8	76.2 (3p)/101.6 (4p)
	A	mm	130	130	130	105 (3p), 140 (4p)
	B	mm	70	70	70	158
	C	mm	70	70	70	70
	D	mm	88	88	88	88
Weight 1-pole Box terminal		kg	--	0.39	--	--
1-pole Lug terminal		kg	--	0.35	--	--
2-pole Box terminal		kg	--	--	0.68	--
2-pole Lug terminal		kg	--	--	0.60	--
3-pole Box terminal		kg	1.02	--	--	1.02
3-pole Lug terminal		kg	0.90	--	--	0.90
4-pole Box terminal		kg	1.31	--	--	1.31
4-pole Lug terminal		kg	1.15	--	--	1.15
General information						
Standards and specifications		IEC 60947-2, -3, -4	IEC 60947-2, -3, -4	IEC 60947-2, -3, -4	IEC 60947-2, -3, -4	IEC 60947-2, -3, -4
Utilization category according to IEC 60947-2		A	A	A	A	A
Power and infeed direction		Top and bottom	Top and bottom	Top and bottom	Top and bottom	Top and bottom
Standard connection system		Lug terminal Box terminal	Lug terminal Box terminal	Lug terminal Box terminal	Lug terminal Box terminal	Lug terminal --
Isolating features according to IEC 60947		✓	✓	✓	✓	✓

✓ Available

-- Not available



3VA20

3VA21

3VA22

3VA23

3VA24

3VA2 molded case circuit breakers for line protection, selectivity applications

3VA20	3VA21	3VA22	3VA23	3VA24
20000	20000	20000	15000	15000
12000	12000	10000	6000	4000
--	--	--	--	--
--	--	--	--	--
--	--	--	--	--
✓	✓	✓	✓	✓
✓	✓	✓	✓	✓
✓	✓	✓	✓	✓
✓	✓	✓	✓	✓
✓	✓	✓	✓	✓
✓	✓	✓	✓	✓

3VA2 molded case circuit breakers for protecting motors/starter combinations (standards and specifications 60947-4-1 acc. to AC-1)

3VA20	3VA21	3VA22	3VA23	3VA24
--	25 ... 100	160 ... 200	250	400 ... 500
20000	20000	20000	15000	15000
12000	12000	10000	6000	4000
--	--	--	--	--
✓	✓	✓	✓	✓
✓	✓	✓	✓	✓
✓	✓	✓	✓	✓

--	--	--	--	--
--	--	--	--	--
--	--	--	--	--
--	--	--	--	--
--	--	--	--	--
--	--	--	--	--

3VA20	3VA21	3VA22	3VA23	3VA24
105 (3p)/140 (4p)	105 (3p)/140 (4p)	105 (3p)/140 (4p)	138 (3p)/184 (4p)	138 (3p)/184 (4p)
181	181	181	248	248
86	86	86	110	110
107	107	107	137	137
--	--	--	--	--
--	--	--	--	--
--	--	--	--	--
2.44	2.44	--	--	--
2.29	2.29	2.41	4.3	4.3
3.14	3.14	--	--	--
2.94	2.94	3.09	4.8	4.8

3VA20	3VA21	3VA22	3VA23	3VA24
IEC 60947-2, -3, -4	IEC 60947-2, -3, -4	IEC 60947-2, -3, -4	IEC 60947-2, -3, -4	IEC 60947-2, -3, -4
A	A	A	A	A/B ¹⁾
Top and bottom	Top and bottom	Top and bottom	Top and bottom	Top and bottom
Lug terminal	Lug terminal	Lug terminal	Lug terminal	Lug terminal
Box terminal	Box terminal	--	--	--
✓	✓	✓	✓	✓

¹⁾ Utilization category B only for 400 A and 500 A and the trip units of the ETU5 and ETU8 series

Molded Case Circuit Breakers

3VA Molded Case Circuit Breakers **NEW**

General data

Molded case circuit breakers and accessories in the system

The new 3VA molded case circuit breakers come with a large portfolio of internal and external accessories which can be installed flexibly in any size of circuit breaker (depending on the type of accessory).

The table below shows the molded case circuit breakers in or on which the accessories can be installed, and the sizes covered by the same accessory component:

Accessories	Molded case circuit breakers								
	3VA1			3VA2					
	100	160	250	100	160	250	400	630	
Auxiliary switches and alarm switches									
Auxiliary releases									
Connection technology									
Plug-in technology									
Draw-out technology									
Front mounted rotary operator									
Door mounted rotary operator									
Side wall mounted rotary operators									
Motor operator MO310 (mounted on the side)									
Motor operator MO320 (mounted on the front)									
Locking and interlocking									
Residual current device (mounted on the side)									
Residual current device (mounted underneath)									
Communications interface									
EFB300									
TD300 and TD500									
Masking frame									
DIN rail adapter									

Front terminals



The portfolio of connection components for the molded case circuit breakers includes a large selection of front cable and busbar terminals.

Connection technology available from/installed at the factory

All 3VA molded case circuit breakers are available as standard with a lug terminal (clip-in nut and clamping screw) at the infeed and load ends.

For units up to size 160 A, a box terminal for direct cable connection can be optionally selected instead of the lug terminal. The box terminal is preassembled and installed at the factory.

The connection technology available from/installed at the factory can be selected in the 12th position of the article number of the molded case circuit breaker.

Connection technology	Illustration	3VA1			3VA2					
		100	160	250	100	160	250	400	630	
Lug terminal		✓	✓	✓	✓	✓	✓	✓	✓	✓
Box terminal		✓	✓	--	✓	✓	--	--	--	

✓ Available

Insulated busbars and cables with cable lugs can be connected directly to the lug terminal. Furthermore, all connection bar extensions are assembled at the molded case circuit breaker using the lug terminal:

- Front connection bars extended (phase barriers included in scope of supply)
- Front connection bars broadened (phase barriers included in scope of supply)
- Front connection bars edgewise (phase barriers included in scope of supply)
- Lug terminal, right-angled (phase barriers included in scope of supply)

The implementation of insulation measures (phase barriers or terminal covers) is recommended. With some accessory components, insulation measures are essential (and these are included in the scope of supply of the relevant component).

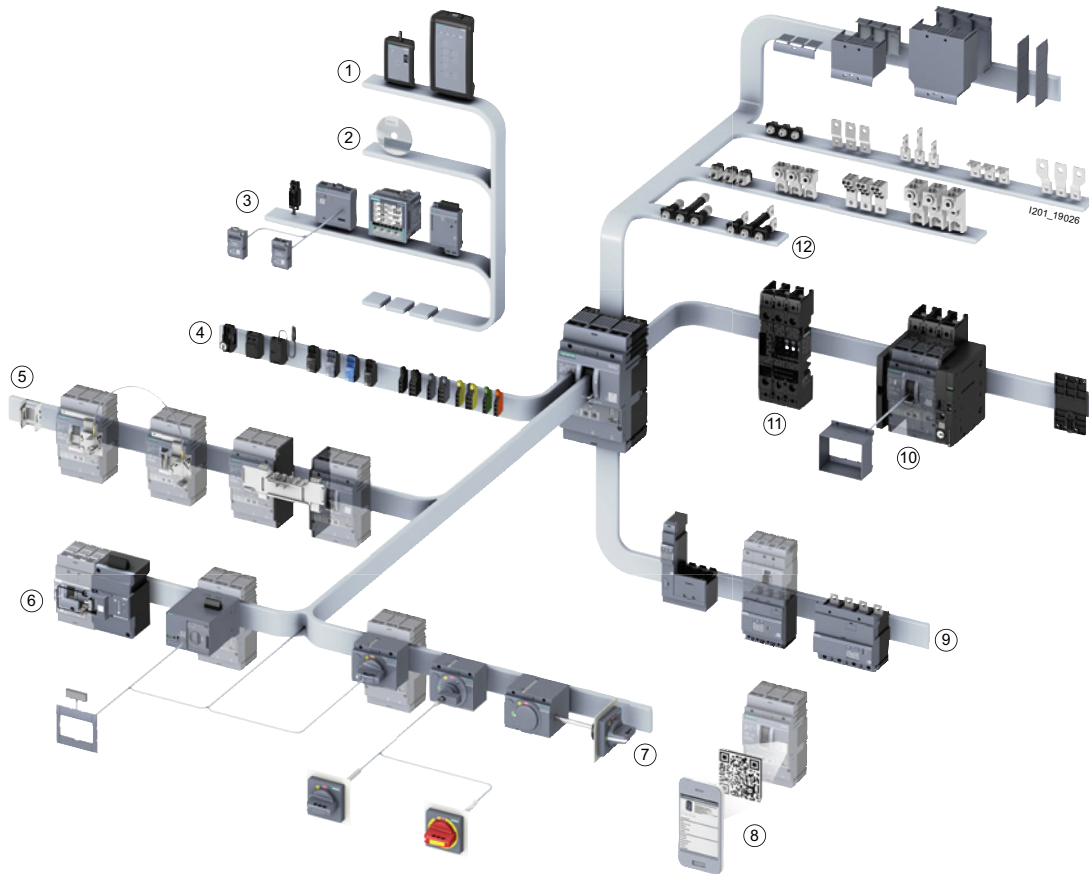

- ① Test devices (pages 2/109)
- ② powerconfig software (pages 2/109, chapter "Measuring Devices and Power Monitoring" and chapter "Software")
- ③ Communication (pages 2/105 to 2/109)
- ④ Internal accessories (pages 2/68 to 2/74)
- ⑤ Locking and interlocking (pages 2/110 to 2/113)
- ⑥ Motor operators (page 2/80)
- ⑦ Manual operators (pages 2/75 to 2/79)
- ⑧ Knowledge Manager (2/11)
- ⑨ Residual current devices (pages 2/101 to 2/103)
- ⑩ Withdrawable unit design (pages 2/96 to 2/100)
- ⑪ Plug-in design (pages 2/96 to 2/100)
- ⑫ Connection technology (pages 2/81 to 2/95)

Knowledge Manager

By reading out the QR code using a smartphone and the "Siemens Industry Online Support" app, it is possible to view key product information via the Internet at any time.

Siemens provides the app free of charge.

Technical information about installation, parameterization or maintenance can be called up directly from the system by QR code on a smartphone.

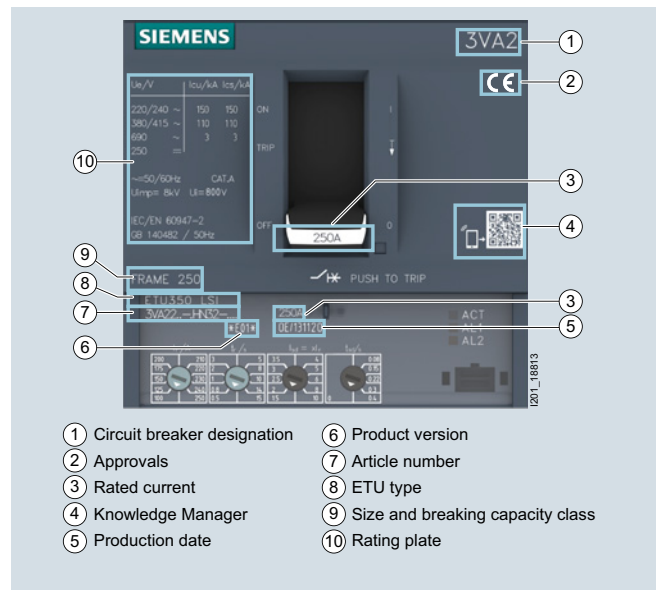

Front: Inscription

- ① Circuit breaker designation
- ② Approvals
- ③ Rated current
- ④ Knowledge Manager
- ⑤ Production date
- ⑥ Product version
- ⑦ Article number
- ⑧ ETU type
- ⑨ Size and breaking capacity class
- ⑩ Rating plate

Molded Case Circuit Breakers

3VA Molded Case Circuit Breakers

NEW

General data

Selectivity

Switching devices connected in series, e.g. molded case circuit breakers and fuses, work in a coordinated manner to ensure that switching devices are tripped successively. The closest, upstream switching device before the location of the short-circuit must trip. The other switching devices on the same current run do not trip. The purpose of selectivity is to minimize the effects of a fault in terms of its duration and the area affected by the fault.

Selectivity is achieved when the circuit breakers are matched to each other by means of selection, configuring and trip settings in such a way that, in the event of a fault, only the breaker closest to the location of the fault trips.

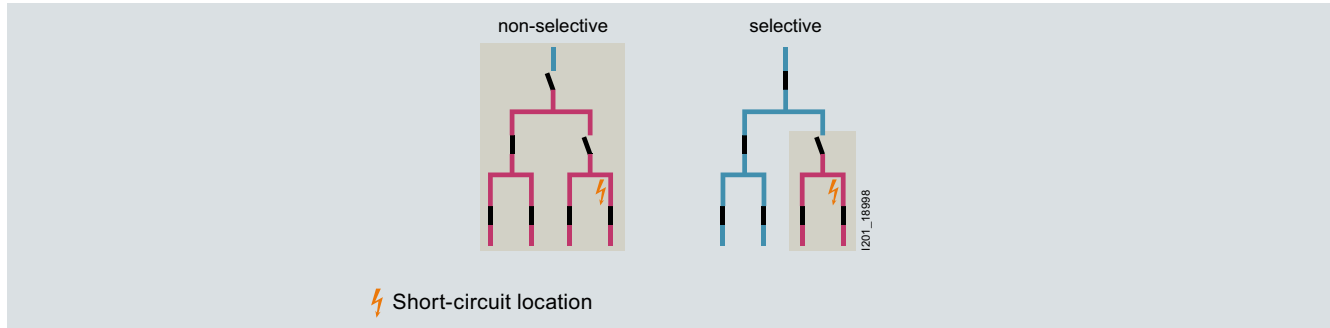

Selectivity with 3VA2 molded case circuit breakers

Series 3VA2 circuit breakers are designed to deliver excellent selective tripping combined with optimum current limiting and outstanding breaking capacity.

3VA2 molded case circuit breakers have been specifically designed to meet the following requirements:

- System-wide, high selectivity with a rated operational current interval of 1 : 2.5 up to the miniature circuit breaker
- Selectivity in combination with high current limiting and high breaking capacity
- Cost-effective design / configuring of selective power distribution systems

You can find information on selectivity values for the 3VA2 molded case circuit breakers on the Internet under the link for the 3VA documentation (www.siemens.com/3VA-documentation).

Current limitation

To achieve excellent current limiting, the 3VA molded case circuit breakers are equipped with a double-rotatory contact system that opens dynamically on its own above the specified disengaging currents on the principle of magnetic repulsion before the expected peak value of the short-circuit current is reached. These limits have been coordinated and optimized to suit the overall device characteristics. This substantially reduces the thermal and mechanical loading on the molded case circuit breaker.

The switching pole cassettes of the 3VA molded case circuit breakers are optimized for high breaking capacity, and their double-rotary contact system design enables extremely good current limiting thanks to the very fast build-up of peak arc voltage generated at both contacts in the event of a short-circuit. This results in significant limitation of the let-through energy I^2t and the expected let-through current I_{SC} .

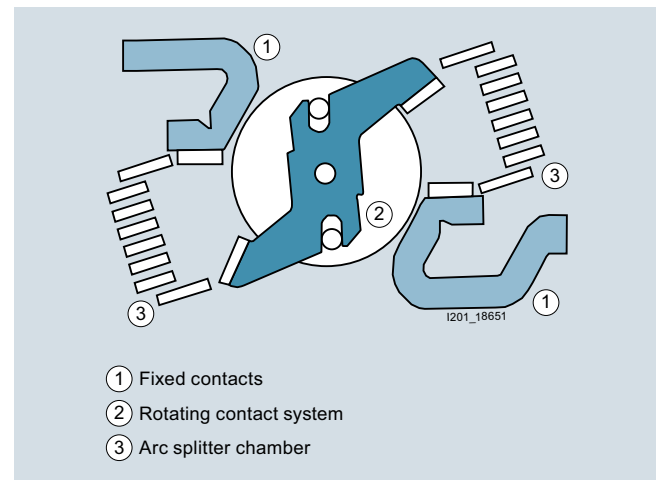

Standards and guidelines

The standards fulfilled by the 3VA molded case circuit breakers include:

- IEC/EN 60947-1
- IEC/EN 60947-2
- IEC / EN 60947-2, Annexes B, M
- IEC/EN 60947-3
- IEC / EN 60947-4-1

Certificates

You can find information on the available certification (CE, CCC, EHC) on the Internet (www.siemens.com/lowvoltage/certificates).

In the Entry List you can use the certificate type (general product approval, explosion protection, test certificates, shipbuilding, etc.) as a filter criterion.

Operating conditions

- Pollution degree:
Operation of the 3VA1 and 3VA2 molded case circuit breakers is approved in accordance with IEC / EN 60947-1 and IEC / EN 60664-1 for pollution degree 3.
- Ambient temperature:
 - 3VA molded case circuit breakers are used at ambient temperatures from -25 °C to +70 °C. At temperatures above +50 °C there are reductions in the rated operational current (derating).
 - The permissible storage temperature in original Siemens packaging lies between -40 °C and +80 °C.

IE3 ready

As from January 2015, the energy-efficiency class IE3 will be mandatory, with a few exceptions only, for three-phase asynchronous motors. This will have an effect on motors, low-voltage power distribution and electrical installation technology, as well as industrial controls.

For use of 3VL molded case circuit breakers in conjunction with highly energy-efficient IE3 motors, please observe the information on dimensioning and configuring, see "Configuration Manual for SIRIUS Controls with IE3 Motors", at <http://support.automation.siemens.com/WW/view/en/94770820>.

Permissible mounting positions

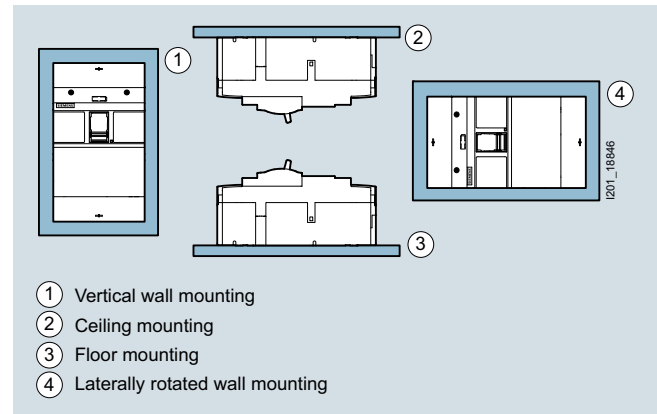

Positions in which the 3VA molded case circuit breakers are allowed to be installed

Are you
IE3 ready?



Molded Case Circuit Breakers





























3VA Molded Case Circuit Breakers

NEW

General data

Protection system

Description of functions

	Thermal-magnetic TM 2-series	Electronic ETU 3-series	Electronic with display ETU 5-series	Electronic with display and metering function – ETU 8-series
Protection				
Trip units	 <p>I_n/A 100A I_n/A</p> <p>I201_19004</p> <p>Line protection: TM210, TM220, TM240 Starter protection: TM120M</p>	 <p>I_n/A I_n/s I_n×I_n I_n/s I_n×I_n</p> <p>I201_18828</p> <p>Line protection: ETU320, ETU330, ETU340, ETU350 Starter protection: ETU310M Motor protection: ETU350M</p>	 <p>ACT COM AL1 AL2</p> <p>I201_18480</p> <p>Line protection: ETU550, ETU560</p>	 <p>ACT COM AL1 AL2</p> <p>I201_18482</p> <p>Line protection: ETU850, ETU860 Motor protection: ETU860M</p>
Integrated functions				
Parameterizing	 <p>Setting and reading the parameters in A</p>	 <p>Setting and reading the parameters in A and s</p>	 <ul style="list-style-type: none"> Setting and reading the parameters via display and communication Fine setting of the parameters Reading the measured values 	 <ul style="list-style-type: none"> Setting and reading the parameters via display and communication Fine setting of the parameters Reading the measured values
Status display	--	 <p>ACT AL1 AL2</p> <p>Indicating the ETU status via LEDs</p>	 <p>ACT COM AL1 AL2</p> <p>Indicating the ETU status via LEDs</p>	 <p>ACT COM AL1 AL2</p> <p>Indicating the ETU status via LEDs</p>
Interface	--	 <p>Interface for test devices</p>	 <p>Interface for test devices</p>	 <p>Interface for test devices</p>
Metering function	--	--	--	Metering function integrated
Optional expansions				
	--	--	 <p>24 V module for continuous power supply (also without primary current through the molded case circuit breaker)</p>	 <p>24 V module for continuous power supply (also without primary current through the molded case circuit breaker)</p>
	--	 <p>EFB300 external function box for connecting to the ETU</p>	 <p>EFB300 external function box for connecting to the ETU</p>	 <p>EFB300 external function box for connecting to the ETU</p>
	--	--	 <p>COM060 communication module</p>	 <p>COM060 communication module</p>
	--	--	 <p>COM800/COM100 breaker data server Interface to</p> <ul style="list-style-type: none"> PROFIBUS PROFINET Modbus RTU Ethernet (Modbus TCP) 	 <p>COM800/COM100 breaker data server Interface to</p> <ul style="list-style-type: none"> PROFIBUS PROFINET Modbus RTU Ethernet (Modbus TCP)
	--	--	 <p>DSP800 external display for installing in the cubicle door</p>	 <p>DSP800 external display for installing in the cubicle door</p>
	--	 <p>TD300/TD500 test device</p>	 <p>TD300/TD500 test device</p>	 <p>TD300/TD500 test device</p>

Protection functions of the 3VA1 molded case circuit breakers with thermal-magnetic trip unit

	TM120M AM	TM210 FTFM	TM220 ATFM	TM240 ATAM
Protection				
Starter protection	✓	--	--	--
Line protection	--	✓	✓	✓
Version available with				
1-pole and 2-pole breakers	--	✓	--	--
3-pole breaker	✓	✓	✓	✓
4-pole breaker	--	✓	✓	✓
Available protection parameters				
I_r adjustable	--	--	✓	✓
I_i adjustable	✓	--	--	✓
I_r fixed	--	✓	--	--
I_i fixed	--	✓	✓	--
$I_N^{1)}$	--	✓	✓	✓

1) 3VA10 only without N protection
 3VA11 without, 50 % or 100 % N protection
 50 % N protection from $I_n \geq 100$ A and only in size 160 A

Protection functions of the 3VA2 with electronic trip unit

	ETU310M I	ETU320 LI	ETU330 LIG	ETU340 ELISA®	ETU350 LSI	ETU350M LSI	ETU550 LSI	ETU560 LSIG	ETU850 LSI	ETU860 LSIG	ETU860M LSIG
Protection											
Starter protection	✓	--	--	--	--	--	--	--	--	--	--
Motor protection	--	--	--	--	--	✓	--	--	--	--	✓
Line protection	--	✓	✓	✓	✓	--	✓	✓	✓	✓	--
Generator protection	--	✓	✓	--	✓	--	✓	✓	✓	✓	--
Version available with											
3-pole without external neutral conductor transformer	✓	✓	✓	✓	✓	✓	--	--	--	--	✓
3-pole with external neutral conductor transformer	--	--	--	--	--	--	✓	✓	✓	✓	--
4-pole with protected neutral conductor	--	✓	✓	✓	✓	--	✓	✓	✓	✓	--
Available protection parameters											
Characteristic in L range	I^2t	I^2t	I^2t	I^4t	I^2t	I^2t	I^2t	I^2t	I^2t	I^2t	I^2t
I_r	--	✓	✓	✓	✓	✓	✓	✓	✓	✓	✓
t_r at $6 \times I_r$	--	✓	✓	--	✓	--	✓	✓	✓	✓	--
t_c	--	--	--	--	--	✓	--	--	--	--	✓
t_p	--	--	--	--	--	--	--	--	--	--	✓
Thermal image	✓	✓	✓	✓	✓	✓	✓	✓	✓	✓	✓
Thermal image can be switched on/off	--	--	--	--	--	--	✓	✓	✓	✓	--
I_{sd}	--	--	--	--	✓	✓	✓	✓	✓	✓	✓
t_{sd} at $8 \times I_r$	--	--	--	--	✓	✓	✓	✓	✓	✓	✓
Characteristic in S range: I^2t_{sd}	--	--	--	--	✓	--	✓	✓	✓	✓	--
Characteristic in S range: selectable I^2t_{sd} / t_{sd}	--	--	--	--	--	--	✓	✓	✓	✓	--
I_i	✓	✓	✓	✓	✓	✓	✓	✓	✓	✓	✓
$I_N^{1)}$	--	✓	✓	✓	✓	--	✓	✓	✓	✓	--
I_g	--	--	✓	--	--	--	--	✓	--	✓	✓
t_g at $2 \times I_g$	--	--	✓	--	--	--	--	✓	--	✓	✓
Characteristic in G range: I^2t_g	--	--	✓	--	--	--	--	✓	--	✓	✓
Characteristic in G range: selectable I^2t_g / t_g	--	--	✓	--	--	--	--	✓	--	✓	✓
Ground-fault alarm function	--	--	--	--	--	--	--	✓	--	✓	✓
Blocking protection	--	--	--	--	--	--	--	--	--	--	✓
ZSI in combination with an EFB external function box	--	✓	✓	✓	✓	✓	✓	✓	✓	✓	✓
Features and options											
Setting by rotary switch	✓	✓	✓	✓	✓	✓	--	--	--	--	--
Setting by ETU display	--	--	--	--	--	--	✓	✓	✓	✓	✓
Data shown on ETU display	--	--	--	--	--	--	✓	✓	✓	✓	✓
Metering function	--	--	--	--	--	--	--	--	✓	✓	✓
Communication option	--	--	--	--	--	--	✓	✓	✓	✓	✓
Front interface	✓	✓	✓	✓	✓	✓	✓	✓	✓	✓	✓

1) Available in a version with external current transformer for N conductor or 4-pole breaker ✓ Available -- Not available

Molded Case Circuit Breakers

3VA1 Molded Case Circuit Breakers up to 250 A, IEC **NEW**

Line protection

Selection and ordering data

PU (UNIT, SET, M) = 1

PS*/P. unit = 1 unit

PG = 1CB



Connection technology

Type

Rated current
 I_n

Current setting of the inverse-time delayed overload protection "L"
 I_r

Operating current of the instantaneous short-circuit protection "I"
 I_i

DT

I_{cu} up to 25 kA at 240 V, low breaking capacity N
See "Overview", p. 2/6 and 2/7

Article No.
www.siemens.com/product?ArticleNo.

Basic price per PU



A

A

A

1-pole, fixed-mounted, 3VA11, up to 160 A Thermal-magnetic trip unit

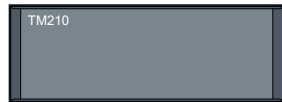

1201_19027

Line protection, 1-pole, TM210 FTFM

With fixed overload protection I_r and fixed short-circuit protection I_i

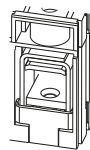

Connection with box terminal

3VA11

16	16	320
20	20	320
25	25	320
32	32	320
40	40	400
50	50	500
63	63	630
80	80	800
100	100	1000
125	125	1250
160	160	1600

3VA1196-3ED16-0AA0
 3VA1120-3ED16-0AA0
 3VA1125-3ED16-0AA0
 3VA1132-3ED16-0AA0

3VA1140-3ED16-0AA0
 3VA1150-3ED16-0AA0
 3VA1163-3ED16-0AA0
 3VA1180-3ED16-0AA0

3VA1110-3ED16-0AA0
 3VA1112-3ED16-0AA0
 3VA1116-3ED16-0AA0

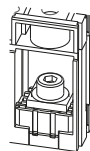
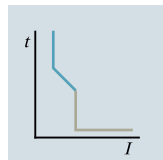

Connection with lug terminal

3VA11

16	16	320
20	20	320
25	25	320
32	32	320
40	40	400
50	50	500
63	63	630
80	80	800
100	100	1000
125	125	1250
160	160	1600

3VA1196-3ED12-0AA0
 3VA1120-3ED12-0AA0
 3VA1125-3ED12-0AA0
 3VA1132-3ED12-0AA0

3VA1140-3ED12-0AA0
 3VA1150-3ED12-0AA0
 3VA1163-3ED12-0AA0
 3VA1180-3ED12-0AA0

3VA1110-3ED12-0AA0
 3VA1112-3ED12-0AA0
 3VA1116-3ED12-0AA0

PU (UNIT, SET, M) = 1

PS*/P. unit = 1 unit

PG = 1CB

Rated current I_n	DT	I_{cu} to 36 kA at 240 V, standard breaking capacity S  See "Overview", p. 2/6 and 2/7 Article No. Basic price www.siemens.com/ product?Article No. per PU
A		

Line protection, 1-pole, TM210 FTFM

With fixed overload protection I_r and fixed short-circuit protection I_f

Connection with box terminal

16	3VA1196-4ED16-0AA0
20	3VA1120-4ED16-0AA0
25	3VA1125-4ED16-0AA0
32	3VA1132-4ED16-0AA0
40	3VA1140-4ED16-0AA0
50	3VA1150-4ED16-0AA0
63	3VA1163-4ED16-0AA0
80	3VA1180-4ED16-0AA0
100 ¹⁾	3VA1110-4ED16-0AA0
125 ¹⁾	3VA1112-4ED16-0AA0
160 ¹⁾	3VA1116-4ED16-0AA0

Connection with lug terminal

16	3VA1196-4ED12-0AA0
20	3VA1120-4ED12-0AA0
25	3VA1125-4ED12-0AA0
32	3VA1132-4ED12-0AA0
40	3VA1140-4ED12-0AA0
50	3VA1150-4ED12-0AA0
63	3VA1163-4ED12-0AA0
80	3VA1180-4ED12-0AA0
100 ¹⁾	3VA1110-4ED12-0AA0
125 ¹⁾	3VA1112-4ED12-0AA0
160 ¹⁾	3VA1116-4ED12-0AA0

¹⁾ Start of delivery scheduled for 4th quarter 2015

Molded Case Circuit Breakers

3VA1 Molded Case Circuit Breakers up to 250 A, IEC **NEW**

Line protection

PU (UNIT, SET, M) = 1

PS*/P. unit = 1 unit

PG = 1CB

2



Connection technology

Type

Rated current
 I_n

Current setting of the inverse-time delayed overload protection "L"
 I_r

Operating current of the instantaneous short-circuit protection "I"
 I_i

DT

I_{cu} up to 25 kA at 415 V, low breaking capacity N
 See "Overview", p. 2/6 and 2/7

(N)

Article No.
www.siemens.com/product?ArticleNo.

Basic price per PU

A

A

A

2-pole, fixed-mounted, 3VA11, up to 160 A Thermal-magnetic trip unit



1201_19027

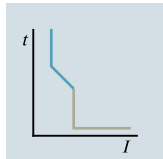

Line protection, 2-pole, TM210 FTFM

With fixed overload protection I_r and fixed short-circuit protection I_i

Connection with box terminal

3VA11

16	16	320
20	20	320
25	25	320
32	32	320
40	40	400
50	50	500
63	63	630
80	80	800
100	100	1000
125	125	1250
160	160	1600

3VA1196-3ED26-0AA0
 3VA1120-3ED26-0AA0
 3VA1125-3ED26-0AA0
 3VA1132-3ED26-0AA0

3VA1140-3ED26-0AA0
 3VA1150-3ED26-0AA0
 3VA1163-3ED26-0AA0
 3VA1180-3ED26-0AA0

3VA1110-3ED26-0AA0
 3VA1112-3ED26-0AA0
 3VA1116-3ED26-0AA0

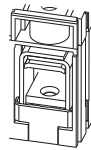

Connection with lug terminal

3VA11

16	16	320
20	20	320
25	25	320
32	32	320
40	40	400
50	50	500
63	63	630
80	80	800
100	100	1000
125	125	1250
160	160	1600

3VA1196-3ED22-0AA0
 3VA1120-3ED22-0AA0
 3VA1125-3ED22-0AA0
 3VA1132-3ED22-0AA0

3VA1140-3ED22-0AA0
 3VA1150-3ED22-0AA0
 3VA1163-3ED22-0AA0
 3VA1180-3ED22-0AA0

3VA1110-3ED22-0AA0
 3VA1112-3ED22-0AA0
 3VA1116-3ED22-0AA0

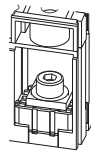

PU (UNIT, SET, M) = 1

PS*/P. unit = 1 unit

PG = 1CB

Rated current I_n	DT	I_{cu} to 36 kA at 415 V, standard breaking capacity S See "Overview", p. 2/6 and 2/7	
A		Article No. www.siemens.com/ product?Article No.	Basic price per PU

2

Line protection, 2-pole, TM210 FTFM

With fixed overload protection I_r and fixed short-circuit protection I_i

Connection with box terminal

16	3VA1196-4ED26-0AA0
20	3VA1120-4ED26-0AA0
25	3VA1125-4ED26-0AA0
32	3VA1132-4ED26-0AA0
40	3VA1140-4ED26-0AA0
50	3VA1150-4ED26-0AA0
63	3VA1163-4ED26-0AA0
80	3VA1180-4ED26-0AA0
100 ¹⁾	3VA1110-4ED26-0AA0
125 ¹⁾	3VA1112-4ED26-0AA0
160 ¹⁾	3VA1116-4ED26-0AA0

Connection with lug terminal

16	3VA1196-4ED22-0AA0
20	3VA1120-4ED22-0AA0
25	3VA1125-4ED22-0AA0
32	3VA1132-4ED22-0AA0
40	3VA1140-4ED22-0AA0
50	3VA1150-4ED22-0AA0
63	3VA1163-4ED22-0AA0
80	3VA1180-4ED22-0AA0
100 ¹⁾	3VA1110-4ED22-0AA0
125 ¹⁾	3VA1112-4ED22-0AA0
160 ¹⁾	3VA1116-4ED22-0AA0

¹⁾ Start of delivery scheduled for 4th quarter 2015

Molded Case Circuit Breakers

3VA1 Molded Case Circuit Breakers up to 250 A, IEC **NEW**

Line protection

PU (UNIT, SET, M) = 1

PS*/P. unit = 1 unit

PG = 1CB

2



Connection technology

Type

Rated current I_n

Current setting of the inverse-time delayed overload protection "L" I_r

Operating current of the instantaneous short-circuit protection "I" I_i

DT

I_{cu} up to 16 kA at 415 V, very low breaking capacity B B
 See "Overview", p. 2/6 and 2/7

Article No.
www.siemens.com/product?ArticleNo.

Basic price per PU

A

A

A

3-pole, fixed-mounted, 3VA10, up to 100 A Thermal-magnetic trip unit

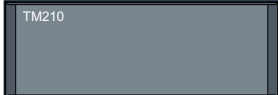

1201_19027

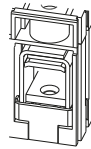
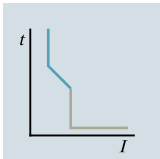

Line protection, TM210 FTFM

With fixed overload protection I_r and fixed short-circuit protection I_i

Connection with box terminal

3VA10	I_n	I_r	I_i	Article No.
3VA10	16	16	320	3VA1096-2ED36-0AA0
	20	20	320	3VA1020-2ED36-0AA0
	25	25	320	3VA1025-2ED36-0AA0
	32	32	320	3VA1032-2ED36-0AA0
3VA10	40	40	400	3VA1040-2ED36-0AA0
	50	50	500	3VA1050-2ED36-0AA0
	63	63	630	3VA1063-2ED36-0AA0
	80	80	800	3VA1080-2ED36-0AA0
	100	100	1000	3VA1010-2ED36-0AA0

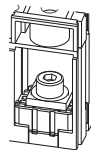

Connection with lug terminal

3VA10	I_n	I_r	I_i	Article No.
3VA10	16	16	320	3VA1096-2ED32-0AA0
	20	20	320	3VA1020-2ED32-0AA0
	25	25	320	3VA1025-2ED32-0AA0
	32	32	320	3VA1032-2ED32-0AA0
3VA10	40	40	400	3VA1040-2ED32-0AA0
	50	50	500	3VA1050-2ED32-0AA0
	63	63	630	3VA1063-2ED32-0AA0
	80	80	800	3VA1080-2ED32-0AA0
	100	100	1000	3VA1010-2ED32-0AA0

PU (UNIT, SET, M) = 1

PS*/P. unit = 1 unit

PG = 1CB

Rated current I_n	DT	I_{cu} up to 25 kA at 415 V, low breaking capacity N See "Overview", p. 2/6 and 2/7	DT	I_{cu} to 36 kA at 415 V, standard breaking capacity S See "Overview", p. 2/6 and 2/7
A		Article No. www.siemens.com/product?Article No. Basic price per PU		Article No. www.siemens.com/product?Article No. Basic price per PU

Line protection, TM210 FTFM

With fixed overload protection I_f and fixed short-circuit protection I_i

Connection with box terminal

16	3VA1096-3ED36-0AA0	3VA1096-4ED36-0AA0
20	3VA1020-3ED36-0AA0	3VA1020-4ED36-0AA0
25	3VA1025-3ED36-0AA0	3VA1025-4ED36-0AA0
32	3VA1032-3ED36-0AA0	3VA1032-4ED36-0AA0
40	3VA1040-3ED36-0AA0	3VA1040-4ED36-0AA0
50	3VA1050-3ED36-0AA0	3VA1050-4ED36-0AA0
63	3VA1063-3ED36-0AA0	3VA1063-4ED36-0AA0
80	3VA1080-3ED36-0AA0	3VA1080-4ED36-0AA0
100	3VA1010-3ED36-0AA0	3VA1010-4ED36-0AA0

Connection with lug terminal

16	3VA1096-3ED32-0AA0	3VA1096-4ED32-0AA0
20	3VA1020-3ED32-0AA0	3VA1020-4ED32-0AA0
25	3VA1025-3ED32-0AA0	3VA1025-4ED32-0AA0
32	3VA1032-3ED32-0AA0	3VA1032-4ED32-0AA0
40	3VA1040-3ED32-0AA0	3VA1040-4ED32-0AA0
50	3VA1050-3ED32-0AA0	3VA1050-4ED32-0AA0
63	3VA1063-3ED32-0AA0	3VA1063-4ED32-0AA0
80	3VA1080-3ED32-0AA0	3VA1080-4ED32-0AA0
100	3VA1010-3ED32-0AA0	3VA1010-4ED32-0AA0

Molded Case Circuit Breakers

3VA1 Molded Case Circuit Breakers up to 250 A, IEC **NEW**

Line protection

PU (UNIT, SET, M) = 1

PS*/P. unit = 1 unit

PG = 1CB

2



Connection technology	Type	Rated current I_n	Current setting of the inverse-time delayed overload protection "L" I_r	Operating current of the instantaneous short-circuit protection "I" I_i	DT	I_{cu} up to 25 kA at 415 V, low breaking capacity N See "Overview", p. 2/6 and 2/7	Article No. www.siemens.com/product?Article No.	Basic price per PU
		A	A	A				

3-pole, fixed-mounted, 3VA11, up to 160 A Thermal-magnetic trip unit



1201_19027

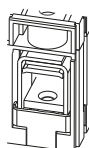
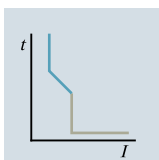

Line protection, TM210 FTFM

With fixed overload protection I_r and fixed short-circuit protection I_i

Connection with box terminal

3VA11	I_n	I_r	I_i	Article No.
16	16	16	320	3VA1196-3ED36-0AA0
	20	20	320	3VA1120-3ED36-0AA0
	25	25	320	3VA1125-3ED36-0AA0
	32	32	320	3VA1132-3ED36-0AA0
40	40	40	400	3VA1140-3ED36-0AA0
	50	50	500	3VA1150-3ED36-0AA0
	63	63	630	3VA1163-3ED36-0AA0
	80	80	800	3VA1180-3ED36-0AA0
100	100	100	1000	3VA1110-3ED36-0AA0
	125	125	1250	3VA1112-3ED36-0AA0
	160	160	1600	3VA1116-3ED36-0AA0

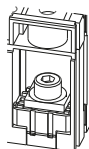

Connection with lug terminal

3VA11	I_n	I_r	I_i	Article No.
16	16	16	320	3VA1196-3ED32-0AA0
	20	20	320	3VA1120-3ED32-0AA0
	25	25	320	3VA1125-3ED32-0AA0
	32	32	320	3VA1132-3ED32-0AA0
40	40	40	400	3VA1140-3ED32-0AA0
	50	50	500	3VA1150-3ED32-0AA0
	63	63	630	3VA1163-3ED32-0AA0
	80	80	800	3VA1180-3ED32-0AA0
100	100	100	1000	3VA1110-3ED32-0AA0
	125	125	1250	3VA1112-3ED32-0AA0
	160	160	1600	3VA1116-3ED32-0AA0



1201_19028

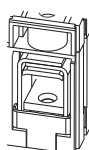
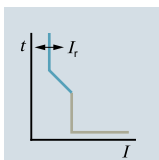

Line protection, TM220 ATFM

With adjustable overload protection I_r and fixed short-circuit protection I_i

Connection with box terminal

3VA11	I_n	I_r	I_i	Article No.
16	16	11 ... 16	320	3VA1196-3EE36-0AA0
	20	14 ... 20	320	3VA1120-3EE36-0AA0
	25	18 ... 25	320	3VA1125-3EE36-0AA0
	32	22 ... 32	320	3VA1132-3EE36-0AA0
40	40	28 ... 40	400	3VA1140-3EE36-0AA0
	50	35 ... 50	500	3VA1150-3EE36-0AA0
	63	44 ... 63	630	3VA1163-3EE36-0AA0
	80	56 ... 80	800	3VA1180-3EE36-0AA0
100	100	70 ... 100	1000	3VA1110-3EE36-0AA0
	125	88 ... 125	1250	3VA1112-3EE36-0AA0
	160	112 ... 160	1600	3VA1116-3EE36-0AA0

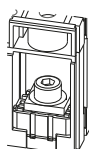

Connection with lug terminal

3VA11	I_n	I_r	I_i	Article No.
16	16	11 ... 16	320	3VA1196-3EE32-0AA0
	20	14 ... 20	320	3VA1120-3EE32-0AA0
	25	18 ... 25	320	3VA1125-3EE32-0AA0
	32	22 ... 32	320	3VA1132-3EE32-0AA0
40	40	28 ... 40	400	3VA1140-3EE32-0AA0
	50	35 ... 50	500	3VA1150-3EE32-0AA0
	63	44 ... 63	630	3VA1163-3EE32-0AA0
	80	56 ... 80	800	3VA1180-3EE32-0AA0
100	100	70 ... 100	1000	3VA1110-3EE32-0AA0
	125	88 ... 125	1250	3VA1112-3EE32-0AA0
	160	112 ... 160	1600	3VA1116-3EE32-0AA0

PU (UNIT, SET, M) = 1

PS*/P. unit = 1 unit

PG = 1CB

Rated current I_n	DT	I_{cu} to 36 kA at 415 V, standard breaking capacity S See "Overview", p. 2/6 and 2/7	DT	I_{cu} up to 55 kA at 415 V, medium breaking capacity M See "Overview", p. 2/6 and 2/7	DT	I_{cu} up to 70 kA at 415 V, high breaking capacity H See "Overview", p. 2/6 and 2/7
A		Article No. www.siemens.com/ product?Article.No. Basic price per PU		Article No. www.siemens.com/ product?Article.No. Basic price per PU		Article No. www.siemens.com/ product?Article.No. Basic price per PU

Line protection, TM210 FTFM

With fixed overload protection I_r and fixed short-circuit protection I_f

Connection with box terminal

16	3VA1196-4ED36-0AA0	3VA1196-5ED36-0AA0	3VA1196-6ED36-0AA0
20	3VA1120-4ED36-0AA0	3VA1120-5ED36-0AA0	3VA1120-6ED36-0AA0
25	3VA1125-4ED36-0AA0	3VA1125-5ED36-0AA0	3VA1125-6ED36-0AA0
32	3VA1132-4ED36-0AA0	3VA1132-5ED36-0AA0	3VA1132-6ED36-0AA0
40	3VA1140-4ED36-0AA0	3VA1140-5ED36-0AA0	3VA1140-6ED36-0AA0
50	3VA1150-4ED36-0AA0	3VA1150-5ED36-0AA0	3VA1150-6ED36-0AA0
63	3VA1163-4ED36-0AA0	3VA1163-5ED36-0AA0	3VA1163-6ED36-0AA0
80	3VA1180-4ED36-0AA0	3VA1180-5ED36-0AA0	3VA1180-6ED36-0AA0
100	3VA1110-4ED36-0AA0	3VA1110-5ED36-0AA0	3VA1110-6ED36-0AA0
125	3VA1112-4ED36-0AA0	3VA1112-5ED36-0AA0	3VA1112-6ED36-0AA0
160	3VA1116-4ED36-0AA0	3VA1116-5ED36-0AA0	3VA1116-6ED36-0AA0

Connection with lug terminal

16	3VA1196-4ED32-0AA0	3VA1196-5ED32-0AA0	3VA1196-6ED32-0AA0
20	3VA1120-4ED32-0AA0	3VA1120-5ED32-0AA0	3VA1120-6ED32-0AA0
25	3VA1125-4ED32-0AA0	3VA1125-5ED32-0AA0	3VA1125-6ED32-0AA0
32	3VA1132-4ED32-0AA0	3VA1132-5ED32-0AA0	3VA1132-6ED32-0AA0
40	3VA1140-4ED32-0AA0	3VA1140-5ED32-0AA0	3VA1140-6ED32-0AA0
50	3VA1150-4ED32-0AA0	3VA1150-5ED32-0AA0	3VA1150-6ED32-0AA0
63	3VA1163-4ED32-0AA0	3VA1163-5ED32-0AA0	3VA1163-6ED32-0AA0
80	3VA1180-4ED32-0AA0	3VA1180-5ED32-0AA0	3VA1180-6ED32-0AA0
100	3VA1110-4ED32-0AA0	3VA1110-5ED32-0AA0	3VA1110-6ED32-0AA0
125	3VA1112-4ED32-0AA0	3VA1112-5ED32-0AA0	3VA1112-6ED32-0AA0
160	3VA1116-4ED32-0AA0	3VA1116-5ED32-0AA0	3VA1116-6ED32-0AA0

Line protection, TM220 ATFM

With adjustable overload protection I_r and fixed short-circuit protection I_f

Connection with box terminal

16	3VA1196-4EE36-0AA0	3VA1196-5EE36-0AA0	3VA1196-6EE36-0AA0
20	3VA1120-4EE36-0AA0	3VA1120-5EE36-0AA0	3VA1120-6EE36-0AA0
25	3VA1125-4EE36-0AA0	3VA1125-5EE36-0AA0	3VA1125-6EE36-0AA0
32	3VA1132-4EE36-0AA0	3VA1132-5EE36-0AA0	3VA1132-6EE36-0AA0
40	3VA1140-4EE36-0AA0	3VA1140-5EE36-0AA0	3VA1140-6EE36-0AA0
50	3VA1150-4EE36-0AA0	3VA1150-5EE36-0AA0	3VA1150-6EE36-0AA0
63	3VA1163-4EE36-0AA0	3VA1163-5EE36-0AA0	3VA1163-6EE36-0AA0
80	3VA1180-4EE36-0AA0	3VA1180-5EE36-0AA0	3VA1180-6EE36-0AA0
100	3VA1110-4EE36-0AA0	3VA1110-5EE36-0AA0	3VA1110-6EE36-0AA0
125	3VA1112-4EE36-0AA0	3VA1112-5EE36-0AA0	3VA1112-6EE36-0AA0
160	3VA1116-4EE36-0AA0	3VA1116-5EE36-0AA0	3VA1116-6EE36-0AA0

Connection with lug terminal

16	3VA1196-4EE32-0AA0	3VA1196-5EE32-0AA0	3VA1196-6EE32-0AA0
20	3VA1120-4EE32-0AA0	3VA1120-5EE32-0AA0	3VA1120-6EE32-0AA0
25	3VA1125-4EE32-0AA0	3VA1125-5EE32-0AA0	3VA1125-6EE32-0AA0
32	3VA1132-4EE32-0AA0	3VA1132-5EE32-0AA0	3VA1132-6EE32-0AA0
40	3VA1140-4EE32-0AA0	3VA1140-5EE32-0AA0	3VA1140-6EE32-0AA0
50	3VA1150-4EE32-0AA0	3VA1150-5EE32-0AA0	3VA1150-6EE32-0AA0
63	3VA1163-4EE32-0AA0	3VA1163-5EE32-0AA0	3VA1163-6EE32-0AA0
80	3VA1180-4EE32-0AA0	3VA1180-5EE32-0AA0	3VA1180-6EE32-0AA0
100	3VA1110-4EE32-0AA0	3VA1110-5EE32-0AA0	3VA1110-6EE32-0AA0
125	3VA1112-4EE32-0AA0	3VA1112-5EE32-0AA0	3VA1112-6EE32-0AA0
160	3VA1116-4EE32-0AA0	3VA1116-5EE32-0AA0	3VA1116-6EE32-0AA0

Molded Case Circuit Breakers

3VA1 Molded Case Circuit Breakers up to 250 A, IEC **NEW**

Line protection

PU (UNIT, SET, M) = 1

PS*/P. unit = 1 unit

PG = 1CB

2



Connection technology

Type

Rated current I_n

Current setting of the inverse-time delayed overload protection "L" I_r

Operating current of the instantaneous short-circuit protection "I" I_i

DT

I_{cu} up to 25 kA at 415 V, low breaking capacity N
 See "Overview", p. 2/6 and 2/7

(N)

Article No.
www.siemens.com/product?ArticleNo.

Basic price per PU

3-pole, fixed-mounted, 3VA11/3VA12, up to 250 A Thermal-magnetic trip unit



1201_19035

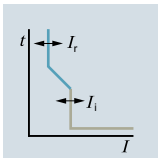

Line protection, TM240 ATAM

With adjustable overload protection I_r and adjustable short-circuit protection I_i

Connection with box terminal

3VA11	16	11 ... 16	160 ... 320	3VA1196-3EF36-0AA0
	20	14 ... 20	160 ... 320	3VA1120-3EF36-0AA0
	25	18 ... 25	160 ... 320	3VA1125-3EF36-0AA0
	32	16 ... 32	160 ... 320	3VA1132-3EF36-0AA0
	40	28 ... 40	200 ... 400	3VA1140-3EF36-0AA0
	50	35 ... 50	250 ... 500	3VA1150-3EF36-0AA0
	63	44 ... 63	315 ... 630	3VA1163-3EF36-0AA0
	80	56 ... 80	400 ... 800	3VA1180-3EF36-0AA0
	100	70 ... 100	500 ... 1000	3VA1110-3EF36-0AA0
	125	88 ... 125	625 ... 1250	3VA1112-3EF36-0AA0
	160	112 ... 160	800 ... 1600	3VA1116-3EF36-0AA0

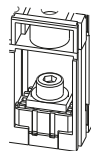

Connection with lug terminal

3VA11	16	11 ... 16	160 ... 320	3VA1196-3EF32-0AA0
	20	14 ... 20	160 ... 320	3VA1120-3EF32-0AA0
	25	18 ... 25	160 ... 320	3VA1125-3EF32-0AA0
	32	16 ... 32	160 ... 320	3VA1132-3EF32-0AA0
	40	28 ... 40	200 ... 400	3VA1140-3EF32-0AA0
	50	35 ... 50	250 ... 500	3VA1150-3EF32-0AA0
	63	44 ... 63	315 ... 630	3VA1163-3EF32-0AA0
	80	56 ... 80	400 ... 800	3VA1180-3EF32-0AA0
3VA12	100	70 ... 100	500 ... 1000	3VA1110-3EF32-0AA0
	125	88 ... 125	625 ... 1250	3VA1112-3EF32-0AA0
	160	112 ... 160	800 ... 1600	3VA1116-3EF32-0AA0
3VA12	160	112 ... 160	800 ... 1600	--
	200	140 ... 200	1000 ... 2000	--
	250	175 ... 250	1250 ... 2500	--

PU (UNIT, SET, M) = 1

PS*/P. unit = 1 unit

PG = 1CB

Rated current I_n	DT	I_{cu} to 36 kA at 415 V, standard breaking capacity S S		I_{cu} up to 55 kA at 415 V, medium breaking capacity M M		I_{cu} up to 70 kA at 415 V, high breaking capacity H H	
		See "Overview", p. 2/6 and 2/7		See "Overview", p. 2/6 and 2/7		See "Overview", p. 2/6 and 2/7	
		Article No.	Basic price per PU	Article No.	Basic price per PU	Article No.	Basic price per PU
A		www.siemens.com/product?Article No.		www.siemens.com/product?Article No.		www.siemens.com/product?Article No.	

Line protection, TM240 ATAM

With adjustable overload protection I_f and adjustable short-circuit protection I_i

Connection with box terminal

Rated current	Article No.	Article No.	Article No.
16	3VA1196-4EF36-0AA0	3VA1196-5EF36-0AA0	3VA1196-6EF36-0AA0
20	3VA1120-4EF36-0AA0	3VA1120-5EF36-0AA0	3VA1120-6EF36-0AA0
25	3VA1125-4EF36-0AA0	3VA1125-5EF36-0AA0	3VA1125-6EF36-0AA0
32	3VA1132-4EF36-0AA0	3VA1132-5EF36-0AA0	3VA1132-6EF36-0AA0
40	3VA1140-4EF36-0AA0	3VA1140-5EF36-0AA0	3VA1140-6EF36-0AA0
50	3VA1150-4EF36-0AA0	3VA1150-5EF36-0AA0	3VA1150-6EF36-0AA0
63	3VA1163-4EF36-0AA0	3VA1163-5EF36-0AA0	3VA1163-6EF36-0AA0
80	3VA1180-4EF36-0AA0	3VA1180-5EF36-0AA0	3VA1180-6EF36-0AA0
100	3VA1110-4EF36-0AA0	3VA1110-5EF36-0AA0	3VA1110-6EF36-0AA0
125	3VA1112-4EF36-0AA0	3VA1112-5EF36-0AA0	3VA1112-6EF36-0AA0
160	3VA1116-4EF36-0AA0	3VA1116-5EF36-0AA0	3VA1116-6EF36-0AA0

Connection with lug terminal

Rated current	Article No.	Article No.	Article No.
16	3VA1196-4EF32-0AA0	3VA1196-5EF32-0AA0	3VA1196-6EF32-0AA0
20	3VA1120-4EF32-0AA0	3VA1120-5EF32-0AA0	3VA1120-6EF32-0AA0
25	3VA1125-4EF32-0AA0	3VA1125-5EF32-0AA0	3VA1125-6EF32-0AA0
32	3VA1132-4EF32-0AA0	3VA1132-5EF32-0AA0	3VA1132-6EF32-0AA0
40	3VA1140-4EF32-0AA0	3VA1140-5EF32-0AA0	3VA1140-6EF32-0AA0
50	3VA1150-4EF32-0AA0	3VA1150-5EF32-0AA0	3VA1150-6EF32-0AA0
63	3VA1163-4EF32-0AA0	3VA1163-5EF32-0AA0	3VA1163-6EF32-0AA0
80	3VA1180-4EF32-0AA0	3VA1180-5EF32-0AA0	3VA1180-6EF32-0AA0
100	3VA1110-4EF32-0AA0	3VA1110-5EF32-0AA0	3VA1110-6EF32-0AA0
125	3VA1112-4EF32-0AA0	3VA1112-5EF32-0AA0	3VA1112-6EF32-0AA0
160	3VA1116-4EF32-0AA0	3VA1116-5EF32-0AA0	3VA1116-6EF32-0AA0
160	3VA1216-4EF32-0AA0	3VA1216-5EF32-0AA0	3VA1216-6EF32-0AA0
200	3VA1220-4EF32-0AA0	3VA1220-5EF32-0AA0	3VA1220-6EF32-0AA0
250	3VA1225-4EF32-0AA0	3VA1225-5EF32-0AA0	3VA1225-6EF32-0AA0

Molded Case Circuit Breakers

3VA1 Molded Case Circuit Breakers up to 250 A, IEC **NEW**

Line protection

PU (UNIT, SET, M) = 1

PS*/P. unit = 1 unit

PG = 1CB

2



Connection technology

Type

Rated current I_n

Current setting of the inverse-time delayed overload protection "L" I_r

Operating current of the instantaneous short-circuit protection "I" I_i

DT

I_{cu} up to 16 kA at 415 V, very low breaking capacity B
See "Overview", p. 2/6 and 2/7

(B)

Article No.
www.siemens.com/product?ArticleNo.

Basic price per PU

A

A

A

4-pole, fixed-mounted, 3VA10, up to 100 A Thermal-magnetic trip unit

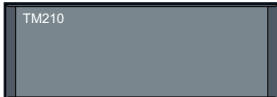

1201_19027

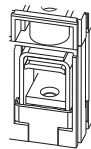
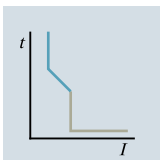

Line protection, TM210 FTFM, without neutral conductor protection

With fixed overload protection I_r and fixed short-circuit protection I_i

Connection with box terminal

3VA10	I_n	I_r	I_i	Article No.
3VA10	16	16	320	3VA1096-2ED46-0AA0
	20	20	320	3VA1020-2ED46-0AA0
	25	25	320	3VA1025-2ED46-0AA0
	32	32	320	3VA1032-2ED46-0AA0
3VA10	40	40	400	3VA1040-2ED46-0AA0
	50	50	500	3VA1050-2ED46-0AA0
	63	63	630	3VA1063-2ED46-0AA0
	80	80	800	3VA1080-2ED46-0AA0
	100	100	1000	3VA1010-2ED46-0AA0

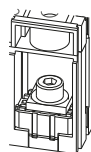

Connection with lug terminal

3VA10	I_n	I_r	I_i	Article No.
3VA10	16	16	320	3VA1096-2ED42-0AA0
	20	20	320	3VA1020-2ED42-0AA0
	25	25	320	3VA1025-2ED42-0AA0
	32	32	320	3VA1032-2ED42-0AA0
3VA10	40	40	400	3VA1040-2ED42-0AA0
	50	50	500	3VA1050-2ED42-0AA0
	63	63	630	3VA1063-2ED42-0AA0
	80	80	800	3VA1080-2ED42-0AA0
	100	100	1000	3VA1010-2ED42-0AA0

PU (UNIT, SET, M) = 1

PS*/P. unit = 1 unit

PG = 1CB

Rated current I_n	DT	I_{cu} up to 25 kA at 415 V, low breaking capacity N See "Overview", p. 2/6 and 2/7	DT	I_{cu} to 36 kA at 415 V, standard breaking capacity S See "Overview", p. 2/6 and 2/7
A		Article No. www.siemens.com/product?Article No. Basic price per PU		Article No. www.siemens.com/product?Article No. Basic price per PU

Line protection, TM210 FTFM, without neutral conductor protection

With fixed overload protection I_r and fixed short-circuit protection I_s

Connection with box terminal

16	3VA1096-3ED46-0AA0	3VA1096-4ED46-0AA0
20	3VA1020-3ED46-0AA0	3VA1020-4ED46-0AA0
25	3VA1025-3ED46-0AA0	3VA1025-4ED46-0AA0
32	3VA1032-3ED46-0AA0	3VA1032-4ED46-0AA0
40	3VA1040-3ED46-0AA0	3VA1040-4ED46-0AA0
50	3VA1050-3ED46-0AA0	3VA1050-4ED46-0AA0
63	3VA1063-3ED46-0AA0	3VA1063-4ED46-0AA0
80	3VA1080-3ED46-0AA0	3VA1080-4ED46-0AA0
100	3VA1010-3ED46-0AA0	3VA1010-4ED46-0AA0

Connection with lug terminal

16	3VA1096-3ED42-0AA0	3VA1096-4ED42-0AA0
20	3VA1020-3ED42-0AA0	3VA1020-4ED42-0AA0
25	3VA1025-3ED42-0AA0	3VA1025-4ED42-0AA0
32	3VA1032-3ED42-0AA0	3VA1032-4ED42-0AA0
40	3VA1040-3ED42-0AA0	3VA1040-4ED42-0AA0
50	3VA1050-3ED42-0AA0	3VA1050-4ED42-0AA0
63	3VA1063-3ED42-0AA0	3VA1063-4ED42-0AA0
80	3VA1080-3ED42-0AA0	3VA1080-4ED42-0AA0
100	3VA1010-3ED42-0AA0	3VA1010-4ED42-0AA0

Molded Case Circuit Breakers

3VA1 Molded Case Circuit Breakers up to 250 A, IEC **NEW**

Line protection

PU (UNIT, SET, M) = 1

PS*/P. unit = 1 unit

PG = 1CB

2



Connection technology

Type

Rated current I_n
A

Current setting of the inverse-time delayed overload protection "L" I_r
A

Operating current of the instantaneous short-circuit protection "I" I_i
A

DT

I_{cu} up to 25 kA at 415 V, low breaking capacity N
 See "Overview", p. 2/6 and 2/7

(N)

Article No.
www.siemens.com/product?ArticleNo.

Basic price per PU

4-pole, fixed-mounted, 3VA11, up to 160 A Thermal-magnetic trip unit



1201_19027

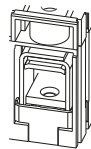
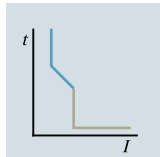

Line protection, TM210 FTFM, without neutral conductor protection

With fixed overload protection I_r and fixed short-circuit protection I_i

Connection with box terminal

3VA11	I_n	I_r	I_i	Article No.
16	16	16	320	3VA1196-3ED46-0AA0
	20	20	320	3VA1120-3ED46-0AA0
	25	25	320	3VA1125-3ED46-0AA0
	32	32	320	3VA1132-3ED46-0AA0
40	40	40	400	3VA1140-3ED46-0AA0
	50	50	500	3VA1150-3ED46-0AA0
	63	63	630	3VA1163-3ED46-0AA0
	80	80	800	3VA1180-3ED46-0AA0
100	100	100	1000	3VA1110-3ED46-0AA0
	125	125	1250	3VA1112-3ED46-0AA0
	160	160	1600	3VA1116-3ED46-0AA0

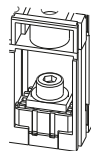

Connection with lug terminal

3VA11	I_n	I_r	I_i	Article No.
16	16	16	320	3VA1196-3ED42-0AA0
	20	20	320	3VA1120-3ED42-0AA0
	25	25	320	3VA1125-3ED42-0AA0
	32	32	320	3VA1132-3ED42-0AA0
40	40	40	400	3VA1140-3ED42-0AA0
	50	50	500	3VA1150-3ED42-0AA0
	63	63	630	3VA1163-3ED42-0AA0
	80	80	800	3VA1180-3ED42-0AA0
100	100	100	1000	3VA1110-3ED42-0AA0
	125	125	1250	3VA1112-3ED42-0AA0
	160	160	1600	3VA1116-3ED42-0AA0



1201_19027

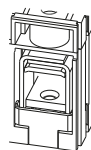
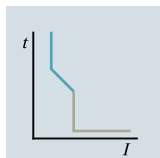

Line protection, TM210 FTFM, 50 % neutral conductor protection

With fixed overload protection I_r and fixed short-circuit protection I_i

Connection with box terminal

3VA11	I_n	I_r	I_i	Article No.
100	100	100	1000	3VA1110-3FD46-0AA0
	125	125	1250	3VA1112-3FD46-0AA0
	160	160	1600	3VA1116-3FD46-0AA0

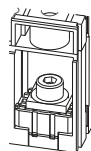

Connection with lug terminal

3VA11	I_n	I_r	I_i	Article No.
100	100	100	1000	3VA1110-3FD42-0AA0
	125	125	1250	3VA1112-3FD42-0AA0
	160	160	1600	3VA1116-3FD42-0AA0

PU (UNIT, SET, M) = 1

PS*/P. unit = 1 unit

PG = 1CB

Rated current I_n	DT	I_{cu} to 36 kA at 415 V, standard breaking capacity S See "Overview", p. 2/6 and 2/7	Basic price per PU	DT	I_{cu} up to 55 kA at 415 V, medium breaking capacity M See "Overview", p. 2/6 and 2/7	Basic price per PU	DT	I_{cu} up to 70 kA at 415 V, high breaking capacity H See "Overview", p. 2/6 and 2/7	Basic price per PU
A		Article No. www.siemens.com/ product?Article.No.		Article No. www.siemens.com/ product?Article.No.		Article No. www.siemens.com/ product?Article.No.			

Line protection, TM210 FTFM, without neutral conductor protection

With fixed overload protection I_r and fixed short-circuit protection I_f

Connection with box terminal

Rated current	3VA1196-4ED46-0AA0	3VA1120-4ED46-0AA0	3VA1125-4ED46-0AA0	3VA1132-4ED46-0AA0	3VA1196-5ED46-0AA0	3VA1120-5ED46-0AA0	3VA1125-5ED46-0AA0	3VA1132-5ED46-0AA0	3VA1196-6ED46-0AA0	3VA1120-6ED46-0AA0	3VA1125-6ED46-0AA0	3VA1132-6ED46-0AA0
16												
20												
25												
32												
40												
50												
63												
80												
100												
125												
160												

Connection with lug terminal

Rated current	3VA1196-4ED42-0AA0	3VA1120-4ED42-0AA0	3VA1125-4ED42-0AA0	3VA1132-4ED42-0AA0	3VA1196-5ED42-0AA0	3VA1120-5ED42-0AA0	3VA1125-5ED42-0AA0	3VA1132-5ED42-0AA0	3VA1196-6ED42-0AA0	3VA1120-6ED42-0AA0	3VA1125-6ED42-0AA0	3VA1132-6ED42-0AA0
16												
20												
25												
32												
40												
50												
63												
80												
100												
125												
160												

Line protection, TM210 FTFM, 50 % neutral conductor protection

With adjustable overload protection I_r and fixed short-circuit protection I_f

Connection with box terminal

Rated current	3VA1110-4FD46-0AA0	3VA1112-4FD46-0AA0	3VA1116-4FD46-0AA0	3VA1110-5FD46-0AA0	3VA1112-5FD46-0AA0	3VA1116-5FD46-0AA0	3VA1110-6FD46-0AA0	3VA1112-6FD46-0AA0	3VA1116-6FD46-0AA0
100									
125									
160									

Connection with lug terminal

Rated current	3VA1110-4FD42-0AA0	3VA1112-4FD42-0AA0	3VA1116-4FD42-0AA0	3VA1110-5FD42-0AA0	3VA1112-5FD42-0AA0	3VA1116-5FD42-0AA0	3VA1110-6FD42-0AA0	3VA1112-6FD42-0AA0	3VA1116-6FD42-0AA0
100									
125									
160									

Molded Case Circuit Breakers

3VA1 Molded Case Circuit Breakers up to 250 A, IEC **NEW**

Line protection

PU (UNIT, SET, M) = 1

PS*/P. unit = 1 unit

PG = 1CB

2



Connection technology

Type

Rated current I_n

Current setting of the inverse-time delayed overload protection "L" I_r

Operating current of the instantaneous short-circuit protection "I" I_i

DT

I_{cu} up to 25 kA at 415 V, low breaking capacity N
 See "Overview", p. 2/6 and 2/7

(N)

Article No. www.siemens.com/product?ArticleNo.

Basic price per PU

A

A

A

4-pole, fixed-mounted, 3VA11, up to 160 A Thermal-magnetic trip unit



1201_19027

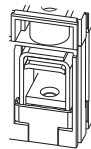
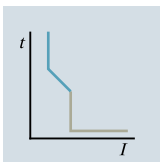

Line protection, TM210 FTFM, 100 % neutral conductor protection With fixed overload protection I_r and fixed short-circuit protection I_i

Connection with box terminal

3VA11	I_n	I_r	I_i	Article No.
16	16	16	320	3VA1196-3GD46-0AA0
	20	20	320	3VA1120-3GD46-0AA0
	25	25	320	3VA1125-3GD46-0AA0
	32	32	320	3VA1132-3GD46-0AA0
40	40	40	400	3VA1140-3GD46-0AA0
	50	50	500	3VA1150-3GD46-0AA0
	63	63	630	3VA1163-3GD46-0AA0
	80	80	800	3VA1180-3GD46-0AA0
100	100	100	1000	3VA1110-3GD46-0AA0
	125	125	1250	3VA1112-3GD46-0AA0
	160	160	1600	3VA1116-3GD46-0AA0

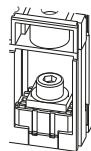

Connection with lug terminal

3VA11	I_n	I_r	I_i	Article No.
16	16	16	320	3VA1196-3GD42-0AA0
	20	20	320	3VA1120-3GD42-0AA0
	25	25	320	3VA1125-3GD42-0AA0
	32	32	320	3VA1132-3GD42-0AA0
40	40	40	400	3VA1140-3GD42-0AA0
	50	50	500	3VA1150-3GD42-0AA0
	63	63	630	3VA1163-3GD42-0AA0
	80	80	800	3VA1180-3GD42-0AA0
100	100	100	1000	3VA1110-3GD42-0AA0
	125	125	1250	3VA1112-3GD42-0AA0
	160	160	1600	3VA1116-3GD42-0AA0



1201_19028

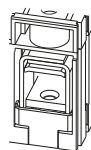
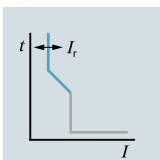

Line protection, TM220 ATFM, without neutral conductor protection With adjustable overload protection I_r and fixed short-circuit protection I_i

Connection with box terminal

3VA11	I_n	I_r	I_i	Article No.
16	16	11 ... 16	320	3VA1196-3EE46-0AA0
	20	14 ... 20	320	3VA1120-3EE46-0AA0
	25	18 ... 25	320	3VA1125-3EE46-0AA0
	32	22 ... 32	320	3VA1132-3EE46-0AA0
40	40	28 ... 40	400	3VA1140-3EE46-0AA0
	50	35 ... 50	500	3VA1150-3EE46-0AA0
	63	44 ... 63	630	3VA1163-3EE46-0AA0
	80	56 ... 80	800	3VA1180-3EE46-0AA0
100	100	70 ... 100	1000	3VA1110-3EE46-0AA0
	125	88 ... 125	1250	3VA1112-3EE46-0AA0
	160	112 ... 160	1600	3VA1116-3EE46-0AA0

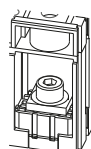

Connection with lug terminal

3VA11	I_n	I_r	I_i	Article No.
16	16	11 ... 16	320	3VA1196-3EE42-0AA0
	20	14 ... 20	320	3VA1120-3EE42-0AA0
	25	18 ... 25	320	3VA1125-3EE42-0AA0
	32	22 ... 32	320	3VA1132-3EE42-0AA0
40	40	28 ... 40	400	3VA1140-3EE42-0AA0
	50	35 ... 50	500	3VA1150-3EE42-0AA0
	63	44 ... 63	630	3VA1163-3EE42-0AA0
	80	56 ... 80	800	3VA1180-3EE42-0AA0
100	100	70 ... 100	1000	3VA1110-3EE42-0AA0
	125	88 ... 125	1250	3VA1112-3EE42-0AA0
	160	112 ... 160	1600	3VA1116-3EE42-0AA0

PU (UNIT, SET, M) = 1

PS*/P. unit = 1 unit

PG = 1CB

Rated current I_n	DT	I_{cu} to 36 kA at 415 V, standard breaking capacity S See "Overview", p. 2/6 and 2/7	DT	I_{cu} up to 55 kA at 415 V, medium breaking capacity M See "Overview", p. 2/6 and 2/7	DT	I_{cu} up to 70 kA at 415 V, high breaking capacity H See "Overview", p. 2/6 and 2/7
A		Article No. www.siemens.com/ product?Article No. Basic price per PU		Article No. www.siemens.com/ product?Article No. Basic price per PU		Article No. www.siemens.com/ product?Article No. Basic price per PU

Line protection, TM210 FTFM, 100 % neutral conductor protection

With fixed overload protection I_r and fixed short-circuit protection I_f

Connection with box terminal

16	3VA1196-4GD46-0AA0	3VA1196-5GD46-0AA0	3VA1196-6GD46-0AA0
20	3VA1120-4GD46-0AA0	3VA1120-5GD46-0AA0	3VA1120-6GD46-0AA0
25	3VA1125-4GD46-0AA0	3VA1125-5GD46-0AA0	3VA1125-6GD46-0AA0
32	3VA1132-4GD46-0AA0	3VA1132-5GD46-0AA0	3VA1132-6GD46-0AA0
40	3VA1140-4GD46-0AA0	3VA1140-5GD46-0AA0	3VA1140-6GD46-0AA0
50	3VA1150-4GD46-0AA0	3VA1150-5GD46-0AA0	3VA1150-6GD46-0AA0
63	3VA1163-4GD46-0AA0	3VA1163-5GD46-0AA0	3VA1163-6GD46-0AA0
80	3VA1180-4GD46-0AA0	3VA1180-5GD46-0AA0	3VA1180-6GD46-0AA0
100	3VA1110-4GD46-0AA0	3VA1110-5GD46-0AA0	3VA1110-6GD46-0AA0
125	3VA1112-4GD46-0AA0	3VA1112-5GD46-0AA0	3VA1112-6GD46-0AA0
160	3VA1116-4GD46-0AA0	3VA1116-5GD46-0AA0	3VA1116-6GD46-0AA0

Connection with lug terminal

16	3VA1196-4GD42-0AA0	3VA1196-5GD42-0AA0	3VA1196-6GD42-0AA0
20	3VA1120-4GD42-0AA0	3VA1120-5GD42-0AA0	3VA1120-6GD42-0AA0
25	3VA1125-4GD42-0AA0	3VA1125-5GD42-0AA0	3VA1125-6GD42-0AA0
32	3VA1132-4GD42-0AA0	3VA1132-5GD42-0AA0	3VA1132-6GD42-0AA0
40	3VA1140-4GD42-0AA0	3VA1140-5GD42-0AA0	3VA1140-6GD42-0AA0
50	3VA1150-4GD42-0AA0	3VA1150-5GD42-0AA0	3VA1150-6GD42-0AA0
63	3VA1163-4GD42-0AA0	3VA1163-5GD42-0AA0	3VA1163-6GD42-0AA0
80	3VA1180-4GD42-0AA0	3VA1180-5GD42-0AA0	3VA1180-6GD42-0AA0
100	3VA1110-4GD42-0AA0	3VA1110-5GD42-0AA0	3VA1110-6GD42-0AA0
125	3VA1112-4GD42-0AA0	3VA1112-5GD42-0AA0	3VA1112-6GD42-0AA0
160	3VA1116-4GD42-0AA0	3VA1116-5GD42-0AA0	3VA1116-6GD42-0AA0

Line protection, TM220 ATFM, without neutral conductor protection

With adjustable overload protection I_r and fixed short-circuit protection I_f

Connection with box terminal

16	3VA1196-4EE46-0AA0	3VA1196-5EE46-0AA0	3VA1196-6EE46-0AA0
20	3VA1120-4EE46-0AA0	3VA1120-5EE46-0AA0	3VA1120-6EE46-0AA0
25	3VA1125-4EE46-0AA0	3VA1125-5EE46-0AA0	3VA1125-6EE46-0AA0
32	3VA1132-4EE46-0AA0	3VA1132-5EE46-0AA0	3VA1132-6EE46-0AA0
40	3VA1140-4EE46-0AA0	3VA1140-5EE46-0AA0	3VA1140-6EE46-0AA0
50	3VA1150-4EE46-0AA0	3VA1150-5EE46-0AA0	3VA1150-6EE46-0AA0
63	3VA1163-4EE46-0AA0	3VA1163-5EE46-0AA0	3VA1163-6EE46-0AA0
80	3VA1180-4EE46-0AA0	3VA1180-5EE46-0AA0	3VA1180-6EE46-0AA0
100	3VA1110-4EE46-0AA0	3VA1110-5EE46-0AA0	3VA1110-6EE46-0AA0
125	3VA1112-4EE46-0AA0	3VA1112-5EE46-0AA0	3VA1112-6EE46-0AA0
160	3VA1116-4EE46-0AA0	3VA1116-5EE46-0AA0	3VA1116-6EE46-0AA0

Connection with lug terminal

16	3VA1196-4EE42-0AA0	3VA1196-5EE42-0AA0	3VA1196-6EE42-0AA0
20	3VA1120-4EE42-0AA0	3VA1120-5EE42-0AA0	3VA1120-6EE42-0AA0
25	3VA1125-4EE42-0AA0	3VA1125-5EE42-0AA0	3VA1125-6EE42-0AA0
32	3VA1132-4EE42-0AA0	3VA1132-5EE42-0AA0	3VA1132-6EE42-0AA0
40	3VA1140-4EE42-0AA0	3VA1140-5EE42-0AA0	3VA1140-6EE42-0AA0
50	3VA1150-4EE42-0AA0	3VA1150-5EE42-0AA0	3VA1150-6EE42-0AA0
63	3VA1163-4EE42-0AA0	3VA1163-5EE42-0AA0	3VA1163-6EE42-0AA0
80	3VA1180-4EE42-0AA0	3VA1180-5EE42-0AA0	3VA1180-6EE42-0AA0
100	3VA1110-4EE42-0AA0	3VA1110-5EE42-0AA0	3VA1110-6EE42-0AA0
125	3VA1112-4EE42-0AA0	3VA1112-5EE42-0AA0	3VA1112-6EE42-0AA0
160	3VA1116-4EE42-0AA0	3VA1116-5EE42-0AA0	3VA1116-6EE42-0AA0

Molded Case Circuit Breakers

3VA1 Molded Case Circuit Breakers up to 250 A, IEC **NEW**

Line protection

PU (UNIT, SET, M) = 1

PS*/P. unit = 1 unit

PG = 1CB

2



Connection technology

Type

Rated current I_n
A

Current setting of the inverse-time delayed overload protection "L" I_r
A

Operating current of the instantaneous short-circuit protection "I" I_i
A

DT

I_{cu} up to 25 kA at 415 V, low breaking capacity N
 See "Overview", p. 2/6 and 2/7 N
 Article No. Basic price per PU
www.siemens.com/product?ArticleNo.

4-pole, fixed-mounted, 3VA11, up to 160 A Thermal-magnetic trip unit



1201_19028

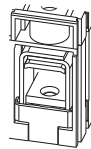
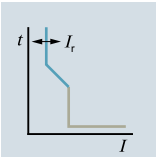

Line protection, TM220 ATFM, 50 % neutral conductor protection With adjustable overload protection I_r and fixed short-circuit protection I_i

Connection with box terminal

3VA11	Rated current I_n	Overload protection I_r	Short-circuit protection I_i
	100	70 ... 100	1000
	125	88 ... 125	1250
	160	112 ... 160	1600

3VA1110-3FE46-0AA0
 3VA1112-3FE46-0AA0
 3VA1116-3FE46-0AA0

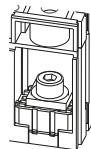

Connection with lug terminal

3VA11	Rated current I_n	Overload protection I_r	Short-circuit protection I_i
	100	70 ... 100	1000
	125	88 ... 125	1250
	160	112 ... 160	1600

3VA1110-3FE42-0AA0
 3VA1112-3FE42-0AA0
 3VA1116-3FE42-0AA0



1201_19028

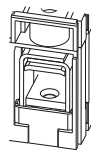
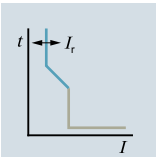

Line protection, TM220 ATFM, 100 % neutral conductor protection With adjustable overload protection I_r and fixed short-circuit protection I_i

Connection with box terminal

3VA11	Rated current I_n	Overload protection I_r	Short-circuit protection I_i
	16	11 ... 16	320
	20	14 ... 20	320
	25	18 ... 25	320
	32	22 ... 32	320
	40	28 ... 40	400
	50	35 ... 50	500
	63	44 ... 63	630
	80	56 ... 80	800
	100	70 ... 100	1000
	125	88 ... 125	1250
	160	112 ... 160	1600

3VA1196-3GE46-0AA0
 3VA1120-3GE46-0AA0
 3VA1125-3GE46-0AA0
 3VA1132-3GE46-0AA0

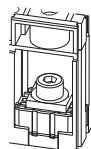

Connection with lug terminal

3VA11	Rated current I_n	Overload protection I_r	Short-circuit protection I_i
	16	11 ... 16	320
	20	14 ... 20	320
	25	18 ... 25	320
	32	22 ... 32	320
	40	28 ... 40	400
	50	35 ... 50	500
	63	44 ... 63	630
	80	56 ... 80	800
	100	70 ... 100	1000
	125	88 ... 125	1250
	160	112 ... 160	1600

3VA1196-3GE42-0AA0
 3VA1120-3GE42-0AA0
 3VA1125-3GE42-0AA0
 3VA1132-3GE42-0AA0
 3VA1140-3GE42-0AA0
 3VA1150-3GE42-0AA0
 3VA1163-3GE42-0AA0
 3VA1180-3GE42-0AA0
 3VA1110-3GE42-0AA0
 3VA1112-3GE42-0AA0
 3VA1116-3GE42-0AA0

PU (UNIT, SET, M) = 1

PS*/P. unit = 1 unit

PG = 1CB

Rated current I_n	DT	I_{cu} to 36 kA at 415 V, standard breaking capacity S See "Overview", p. 2/6 and 2/7	Basic price per PU	DT	I_{cu} up to 55 kA at 415 V, medium breaking capacity M See "Overview", p. 2/6 and 2/7	Basic price per PU	DT	I_{cu} up to 70 kA at 415 V, high breaking capacity H See "Overview", p. 2/6 and 2/7	Basic price per PU
A		Article No. www.siemens.com/ product?Article No.			Article No. www.siemens.com/ product?Article No.			Article No. www.siemens.com/ product?Article No.	

Line protection, TM220 ATFM, 50 % neutral conductor protection

With adjustable overload protection I_f and fixed short-circuit protection I_f

Rated current I_n	Connection with box terminal		
	3VA1110-4FE46-0AA0	3VA1110-5FE46-0AA0	3VA1110-6FE46-0AA0
100	3VA1112-4FE46-0AA0	3VA1112-5FE46-0AA0	3VA1112-6FE46-0AA0
125	3VA1116-4FE46-0AA0	3VA1116-5FE46-0AA0	3VA1116-6FE46-0AA0
160			

Rated current I_n	Connection with lug terminal		
	3VA1110-4FE42-0AA0	3VA1110-5FE42-0AA0	3VA1110-6FE42-0AA0
100	3VA1112-4FE42-0AA0	3VA1112-5FE42-0AA0	3VA1112-6FE42-0AA0
125	3VA1116-4FE42-0AA0	3VA1116-5FE42-0AA0	3VA1116-6FE42-0AA0
160			

Line protection, TM220 ATFM, 100 % neutral conductor protection

With adjustable overload protection I_f and fixed short-circuit protection I_f

Rated current I_n	Connection with box terminal		
	3VA1196-4GE46-0AA0	3VA1196-5GE46-0AA0	3VA1196-6GE46-0AA0
16	3VA1120-4GE46-0AA0	3VA1120-5GE46-0AA0	3VA1120-6GE46-0AA0
20	3VA1125-4GE46-0AA0	3VA1125-5GE46-0AA0	3VA1125-6GE46-0AA0
25	3VA1132-4GE46-0AA0	3VA1132-5GE46-0AA0	3VA1132-6GE46-0AA0
32			
40	3VA1140-4GE46-0AA0	3VA1140-5GE46-0AA0	3VA1140-6GE46-0AA0
50	3VA1150-4GE46-0AA0	3VA1150-5GE46-0AA0	3VA1150-6GE46-0AA0
63	3VA1163-4GE46-0AA0	3VA1163-5GE46-0AA0	3VA1163-6GE46-0AA0
80	3VA1180-4GE46-0AA0	3VA1180-5GE46-0AA0	3VA1180-6GE46-0AA0
100	3VA1110-4GE46-0AA0	3VA1110-5GE46-0AA0	3VA1110-6GE46-0AA0
125	3VA1112-4GE46-0AA0	3VA1112-5GE46-0AA0	3VA1112-6GE46-0AA0
160	3VA1116-4GE46-0AA0	3VA1116-5GE46-0AA0	3VA1116-6GE46-0AA0

Rated current I_n	Connection with lug terminal		
	3VA1196-4GE42-0AA0	3VA1196-5GE42-0AA0	3VA1196-6GE42-0AA0
16	3VA1120-4GE42-0AA0	3VA1120-5GE42-0AA0	3VA1120-6GE42-0AA0
20	3VA1125-4GE42-0AA0	3VA1125-5GE42-0AA0	3VA1125-6GE42-0AA0
25	3VA1132-4GE42-0AA0	3VA1132-5GE42-0AA0	3VA1132-6GE42-0AA0
32			
40	3VA1140-4GE42-0AA0	3VA1140-5GE42-0AA0	3VA1140-6GE42-0AA0
50	3VA1150-4GE42-0AA0	3VA1150-5GE42-0AA0	3VA1150-6GE42-0AA0
63	3VA1163-4GE42-0AA0	3VA1163-5GE42-0AA0	3VA1163-6GE42-0AA0
80	3VA1180-4GE42-0AA0	3VA1180-5GE42-0AA0	3VA1180-6GE42-0AA0
100	3VA1110-4GE42-0AA0	3VA1110-5GE42-0AA0	3VA1110-6GE42-0AA0
125	3VA1112-4GE42-0AA0	3VA1112-5GE42-0AA0	3VA1112-6GE42-0AA0
160	3VA1116-4GE42-0AA0	3VA1116-5GE42-0AA0	3VA1116-6GE42-0AA0

Molded Case Circuit Breakers

3VA1 Molded Case Circuit Breakers up to 250 A, IEC **NEW**

Line protection

PU (UNIT, SET, M) = 1

PS*/P. unit = 1 unit

PG = 1CB

2



Connection technology

Type

Rated current I_n

Current setting of the inverse-time delayed overload protection "L" I_r

Operating current of the instantaneous short-circuit protection "I" I_i

DT

I_{cu} up to 25 kA at 415 V, low breaking capacity N
 See "Overview", p. 2/6 and 2/7

Article No.
www.siemens.com/product?ArticleNo.

Basic price per PU

(N)

A

A

A

4-pole, fixed-mounted, 3VA11/3VA12, up to 250 A Thermal-magnetic trip unit



i201_19035

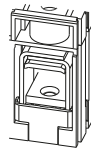
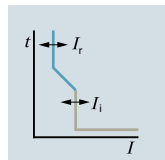

Line protection, TM240 ATAM, without neutral conductor protection

With adjustable overload protection I_r and adjustable short-circuit protection I_i

Connection with box terminal

3VA11	I_n	I_r	I_i	Article No.
3VA11	16	11 ... 16	160 ... 320	3VA1196-3EF46-0AA0
	20	14 ... 20	160 ... 320	3VA1120-3EF46-0AA0
	25	18 ... 25	160 ... 320	3VA1125-3EF46-0AA0
	32	16 ... 32	160 ... 320	3VA1132-3EF46-0AA0
	40	28 ... 40	200 ... 400	3VA1140-3EF46-0AA0
	50	35 ... 50	250 ... 500	3VA1150-3EF46-0AA0
	63	44 ... 63	315 ... 630	3VA1163-3EF46-0AA0
	80	56 ... 80	400 ... 800	3VA1180-3EF46-0AA0
	100	70 ... 100	500 ... 1000	3VA1110-3EF46-0AA0
	125	88 ... 125	625 ... 1250	3VA1112-3EF46-0AA0
	160	112 ... 160	800 ... 1600	3VA1116-3EF46-0AA0

Connection with lug terminal

3VA11	I_n	I_r	I_i	Article No.
3VA11	16	11 ... 16	160 ... 320	3VA1196-3EF42-0AA0
	20	14 ... 20	160 ... 320	3VA1120-3EF42-0AA0
	25	18 ... 25	160 ... 320	3VA1125-3EF42-0AA0
	32	16 ... 32	160 ... 320	3VA1132-3EF42-0AA0
	40	28 ... 40	200 ... 400	3VA1140-3EF42-0AA0
	50	35 ... 50	250 ... 500	3VA1150-3EF42-0AA0
	63	44 ... 63	315 ... 630	3VA1163-3EF42-0AA0
	80	56 ... 80	400 ... 800	3VA1180-3EF42-0AA0
	100	70 ... 100	500 ... 1000	3VA1110-3EF42-0AA0
	125	88 ... 125	625 ... 1250	3VA1112-3EF42-0AA0
	160	112 ... 160	800 ... 1600	3VA1116-3EF42-0AA0
3VA12	160	112 ... 160	800 ... 1600	--
	200	140 ... 200	1000 ... 2000	--
	250	175 ... 250	1250 ... 2500	--

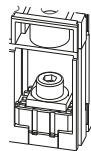

Line protection, TM240 ATAM, 50 % neutral conductor protection

With adjustable overload protection I_r and adjustable short-circuit protection I_i

Connection with box terminal

3VA11	I_n	I_r	I_i	Article No.
3VA11	100	70 ... 100	500 ... 1000	3VA1110-3FF46-0AA0
	125	88 ... 125	625 ... 1250	3VA1112-3FF46-0AA0
	160	112 ... 160	800 ... 1600	3VA1116-3FF46-0AA0

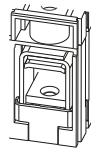

Connection with lug terminal

3VA11	I_n	I_r	I_i	Article No.
3VA11	100	70 ... 100	500 ... 1000	3VA1110-3FF42-0AA0
	125	88 ... 125	625 ... 1250	3VA1112-3FF42-0AA0
	160	112 ... 160	800 ... 1600	3VA1116-3FF42-0AA0
3VA12	160	112 ... 160	800 ... 1600	--
	200	140 ... 200	1000 ... 2000	--
	250	175 ... 250	1250 ... 2500	--

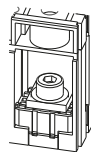

i201_19035

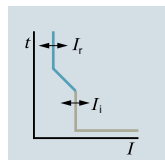

PU (UNIT, SET, M) = 1

PS*/P. unit = 1 unit

PG = 1CB

Rated current I_n	DT	I_{cu} to 36 kA at 415 V, standard breaking capacity S See "Overview", p. 2/6 and 2/7	Basic price per PU	DT	I_{cu} up to 55 kA at 415 V, medium breaking capacity M See "Overview", p. 2/6 and 2/7	Basic price per PU	DT	I_{cu} up to 70 kA at 415 V, high breaking capacity H See "Overview", p. 2/6 and 2/7	Basic price per PU
A		Article No. www.siemens.com/ product?Article No.		Article No. www.siemens.com/ product?Article No.		Article No. www.siemens.com/ product?Article No.		Article No. www.siemens.com/ product?Article No.	

Line protection, TM240 ATAM, without neutral conductor protection

With adjustable overload protection I_r and adjustable short-circuit protection I_i

Connection with box terminal

16	3VA1196-4EF46-0AA0	3VA1196-5EF46-0AA0	3VA1196-6EF46-0AA0
20	3VA1120-4EF46-0AA0	3VA1120-5EF46-0AA0	3VA1120-6EF46-0AA0
25	3VA1125-4EF46-0AA0	3VA1125-5EF46-0AA0	3VA1125-6EF46-0AA0
32	3VA1132-4EF46-0AA0	3VA1132-5EF46-0AA0	3VA1132-6EF46-0AA0
40	3VA1140-4EF46-0AA0	3VA1140-5EF46-0AA0	3VA1140-6EF46-0AA0
50	3VA1150-4EF46-0AA0	3VA1150-5EF46-0AA0	3VA1150-6EF46-0AA0
63	3VA1163-4EF46-0AA0	3VA1163-5EF46-0AA0	3VA1163-6EF46-0AA0
80	3VA1180-4EF46-0AA0	3VA1180-5EF46-0AA0	3VA1180-6EF46-0AA0
100	3VA1110-4EF46-0AA0	3VA1110-5EF46-0AA0	3VA1110-6EF46-0AA0
125	3VA1112-4EF46-0AA0	3VA1112-5EF46-0AA0	3VA1112-6EF46-0AA0
160	3VA1116-4EF46-0AA0	3VA1116-5EF46-0AA0	3VA1116-6EF46-0AA0

Connection with lug terminal

16	3VA1196-4EF42-0AA0	3VA1196-5EF42-0AA0	3VA1196-6EF42-0AA0
20	3VA1120-4EF42-0AA0	3VA1120-5EF42-0AA0	3VA1120-6EF42-0AA0
25	3VA1125-4EF42-0AA0	3VA1125-5EF42-0AA0	3VA1125-6EF42-0AA0
32	3VA1132-4EF42-0AA0	3VA1132-5EF42-0AA0	3VA1132-6EF42-0AA0
40	3VA1140-4EF42-0AA0	3VA1140-5EF42-0AA0	3VA1140-6EF42-0AA0
50	3VA1150-4EF42-0AA0	3VA1150-5EF42-0AA0	3VA1150-6EF42-0AA0
63	3VA1163-4EF42-0AA0	3VA1163-5EF42-0AA0	3VA1163-6EF42-0AA0
80	3VA1180-4EF42-0AA0	3VA1180-5EF42-0AA0	3VA1180-6EF42-0AA0
100	3VA1110-4EF42-0AA0	3VA1110-5EF42-0AA0	3VA1110-6EF42-0AA0
125	3VA1112-4EF42-0AA0	3VA1112-5EF42-0AA0	3VA1112-6EF42-0AA0
160	3VA1116-4EF42-0AA0	3VA1116-5EF42-0AA0	3VA1116-6EF42-0AA0
160	3VA1216-4EF42-0AA0	3VA1216-5EF42-0AA0	3VA1216-6EF42-0AA0
200	3VA1220-4EF42-0AA0	3VA1220-5EF42-0AA0	3VA1220-6EF42-0AA0
250	3VA1225-4EF42-0AA0	3VA1225-5EF42-0AA0	3VA1225-6EF42-0AA0

Line protection, TM240 ATAM, 50 % neutral conductor protection

With adjustable overload protection I_r and adjustable short-circuit protection I_i

Connection with box terminal

100	3VA1110-4FF46-0AA0	3VA1110-5FF46-0AA0	3VA1110-6FF46-0AA0
125	3VA1112-4FF46-0AA0	3VA1112-5FF46-0AA0	3VA1112-6FF46-0AA0
160	3VA1116-4FF46-0AA0	3VA1116-5FF46-0AA0	3VA1116-6FF46-0AA0

Connection with lug terminal

100	3VA1110-4FF42-0AA0	3VA1110-5FF42-0AA0	3VA1110-6FF42-0AA0
125	3VA1112-4FF42-0AA0	3VA1112-5FF42-0AA0	3VA1112-6FF42-0AA0
160	3VA1116-4FF42-0AA0	3VA1116-5FF42-0AA0	3VA1116-6FF42-0AA0
160	3VA1216-4FF42-0AA0	3VA1216-5FF42-0AA0	3VA1216-6FF42-0AA0
200	3VA1220-4FF42-0AA0	3VA1220-5FF42-0AA0	3VA1220-6FF42-0AA0
250	3VA1225-4FF42-0AA0	3VA1225-5FF42-0AA0	3VA1225-6FF42-0AA0

Molded Case Circuit Breakers

3VA1 Molded Case Circuit Breakers up to 250 A, IEC **NEW**

Line protection

PU (UNIT, SET, M) = 1

PS*/P. unit = 1 unit

PG = 1CB

2



Connection technology

Type

Rated current I_n

Current setting of the inverse-time delayed overload protection "L" I_r

Operating current of the instantaneous short-circuit protection "I" I_i

DT

I_{cu} up to 25 kA at 415 V, low breaking capacity N
 See "Overview", p. 2/6 and 2/7

(N)

Article No.
www.siemens.com/product?ArticleNo.

Basic price per PU

A

A

A

4-pole, fixed-mounted, 3VA11/3VA12, up to 250 A Thermal-magnetic trip unit



1201_19035

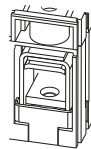
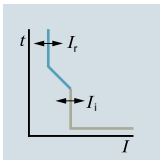

Line protection, TM240 ATAM, 100 % neutral conductor protection With adjustable overload protection I_r and adjustable short-circuit protection I_i

Connection with box terminal

Rated current I_n	Overload protection I_r	Instantaneous short-circuit protection I_i	Article No.	
3VA11	16	11 ... 16	160 ... 320	3VA1196-3GF46-0AA0
	20	14 ... 20	160 ... 320	3VA1120-3GF46-0AA0
	25	18 ... 25	160 ... 320	3VA1125-3GF46-0AA0
	32	16 ... 32	160 ... 320	3VA1132-3GF46-0AA0
	40	28 ... 40	200 ... 400	3VA1140-3GF46-0AA0
	50	35 ... 50	250 ... 500	3VA1150-3GF46-0AA0
	63	44 ... 63	315 ... 630	3VA1163-3GF46-0AA0
	80	56 ... 80	400 ... 800	3VA1180-3GF46-0AA0
	100	70 ... 100	500 ... 1000	3VA1110-3GF46-0AA0
	125	88 ... 125	625 ... 1250	3VA1112-3GF46-0AA0
	160	112 ... 160	800 ... 1600	3VA1116-3GF46-0AA0

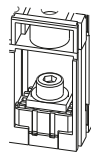

Connection with lug terminal

Rated current I_n	Overload protection I_r	Instantaneous short-circuit protection I_i	Article No.	
3VA11	16	11 ... 16	160 ... 320	3VA1196-3GF42-0AA0
	20	14 ... 20	160 ... 320	3VA1120-3GF42-0AA0
	25	18 ... 25	160 ... 320	3VA1125-3GF42-0AA0
	32	16 ... 32	160 ... 320	3VA1132-3GF42-0AA0
	40	28 ... 40	200 ... 400	3VA1140-3GF42-0AA0
	50	35 ... 50	250 ... 500	3VA1150-3GF42-0AA0
	63	44 ... 63	315 ... 630	3VA1163-3GF42-0AA0
	80	56 ... 80	400 ... 800	3VA1180-3GF42-0AA0
	100	70 ... 100	500 ... 1000	3VA1110-3GF42-0AA0
	125	88 ... 125	625 ... 1250	3VA1112-3GF42-0AA0
	160	112 ... 160	800 ... 1600	3VA1116-3GF42-0AA0
3VA12	160	112 ... 160	800 ... 1600	--
	200	140 ... 200	1000 ... 2000	--
	250	175 ... 250	1250 ... 2500	--

PU (UNIT, SET, M) = 1

PS*/P. unit = 1 unit

PG = 1CB

Rated current I_n	DT	I_{cu} to 36 kA at 415 V, standard breaking capacity S S		I_{cu} up to 55 kA at 415 V, medium breaking capacity M M		I_{cu} up to 70 kA at 415 V, high breaking capacity H H	
		See "Overview", p. 2/6 and 2/7		See "Overview", p. 2/6 and 2/7		See "Overview", p. 2/6 and 2/7	
A		Article No. www.siemens.com/product?Article No.	Basic price per PU	Article No. www.siemens.com/product?Article No.	Basic price per PU	Article No. www.siemens.com/product?Article No.	Basic price per PU

Line protection, TM240 ATAM, 100 % neutral conductor protection

With adjustable overload protection I_f and adjustable short-circuit protection I_t

Connection with box terminal

Rated current	3VA1196-4GF46-0AA0	3VA1120-4GF46-0AA0	3VA1125-4GF46-0AA0	3VA1132-4GF46-0AA0	3VA1196-5GF46-0AA0	3VA1120-5GF46-0AA0	3VA1125-5GF46-0AA0	3VA1132-5GF46-0AA0	3VA1196-6GF46-0AA0	3VA1120-6GF46-0AA0	3VA1125-6GF46-0AA0	3VA1132-6GF46-0AA0
16												
20												
25												
32												
40												
50												
63												
80												
100												
125												
160												

Connection with lug terminal

Rated current	3VA1196-4GF42-0AA0	3VA1120-4GF42-0AA0	3VA1125-4GF42-0AA0	3VA1132-4GF42-0AA0	3VA1196-5GF42-0AA0	3VA1120-5GF42-0AA0	3VA1125-5GF42-0AA0	3VA1132-5GF42-0AA0	3VA1196-6GF42-0AA0	3VA1120-6GF42-0AA0	3VA1125-6GF42-0AA0	3VA1132-6GF42-0AA0
16												
20												
25												
32												
40												
50												
63												
80												
100												
125												
160												
160												
200												
250												

Molded Case Circuit Breakers

3VA1 Molded Case Circuit Breakers up to 250 A, IEC **NEW**

Starter protection

PU (UNIT, SET, M) = 1

PS*/P. unit = 1 unit

PG = 1CB

2



Connection technology	Type	Rated current I_n	Current setting of the inverse-time delayed overload protection "L" I_r	Operating current of the instantaneous short-circuit protection "I" I_i	DT	I_{cu} up to 55 kA at 415 V, medium breaking capacity M See "Overview", p. 2/6 and 2/7	Article No. www.siemens.com/product?ArticleNo.	Basic price per PU
		A	A	A				

3-pole, fixed-mounted, 3VA11/3VA12, up to 200 A Magnetic trip unit



Starter protection, TM120M AM With adjustable short-circuit protection I_i

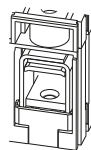
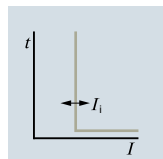

Connection with box terminal

3VA11	Rated current I_n	Current setting I_r	Operating current I_i	Article No.
3VA11	32	--	220 ... 510	3VA1132-5MH36-0AA0
	40	--	280 ... 640	3VA1140-5MH36-0AA0
	50	--	350 ... 800	3VA1150-5MH36-0AA0
3VA11	63	--	440 ... 1010	3VA1163-5MH36-0AA0
	80	--	560 ... 1280	3VA1180-5MH36-0AA0
	100	--	700 ... 1600	3VA1110-5MH36-0AA0
	125	--	875 ... 2000	3VA1112-5MH36-0AA0

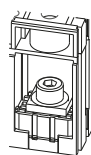

Connection with lug terminal

3VA11	Rated current I_n	Current setting I_r	Operating current I_i	Article No.
3VA11	32	--	220 ... 510	3VA1132-5MH32-0AA0
	40	--	280 ... 640	3VA1140-5MH32-0AA0
	50	--	350 ... 800	3VA1150-5MH32-0AA0
3VA11	63	--	440 ... 1010	3VA1163-5MH32-0AA0
	80	--	560 ... 1280	3VA1180-5MH32-0AA0
	100	--	700 ... 1600	3VA1110-5MH32-0AA0
	125	--	875 ... 2000	3VA1112-5MH32-0AA0
	3VA12	160	--	1120 ... 2560
200		--	1200 ... 2800	3VA1220-5MH32-0AA0

PU (UNIT, SET, M) = 1

PS*/P. unit = 1 unit

PG = 1CB

Rated current I_n	DT	I_{cu} up to 70 kA at 415 V, high breaking capacity H See "Overview", p. 2/6 and 2/7 Article No. www.siemens.com/product?Article No.	 Basic price per PU
A			

Starter protection, TM120M AM

With adjustable short-circuit protection I_f

Connection with box terminal

32	3VA1132-6MH36-0AA0
40	3VA1140-6MH36-0AA0
50	3VA1150-6MH36-0AA0
63	3VA1163-6MH36-0AA0
80	3VA1180-6MH36-0AA0
100	3VA1110-6MH36-0AA0
125	3VA1112-6MH36-0AA0

Connection with lug terminal

32	3VA1132-6MH32-0AA0
40	3VA1140-6MH32-0AA0
50	3VA1150-6MH32-0AA0
63	3VA1163-6MH32-0AA0
80	3VA1180-6MH32-0AA0
100	3VA1110-6MH32-0AA0
125	3VA1112-6MH32-0AA0
160	3VA1216-6MH32-0AA0
200	3VA1220-6MH32-0AA0

Molded Case Circuit Breakers

3VA1 Molded Case Circuit Breakers up to 250 A, IEC **NEW**

Switch disconnectors

Selection and ordering data

PU (UNIT, SET, M) = 1

PS*/P. unit = 1 unit

PG = 1CB

Connection technology	Type	Rated uninterrupted current I_u	Current setting of the inverse-time delayed overload protection "L" I_r	Operating current of the instantaneous short-circuit protection "I" I_i	DT	Article No. www.siemens.com/product?ArticleNo.	Basic price per PU
		A	A	A			

3-pole, fixed-mounted, 3VA11/3VA12, up to 250 A
Without trip unit

Switch disconnector without SD100 trip unit

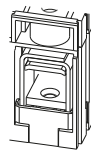

Connection with box terminal

3VA11	63	--	--	
	100	--	--	
	125	--	--	
	160	--	--	

[3VA1163-1AA36-0AA0](#)
[3VA1110-1AA36-0AA0](#)
[3VA1112-1AA36-0AA0](#)
[3VA1116-1AA36-0AA0](#)

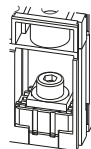

Connection with lug terminal

3VA11	63	--	--	
	100	--	--	
	125	--	--	
	160	--	--	
3VA12	250	--	--	

[3VA1163-1AA32-0AA0](#)
[3VA1110-1AA32-0AA0](#)
[3VA1112-1AA32-0AA0](#)
[3VA1116-1AA32-0AA0](#)
[3VA1225-1AA32-0AA0](#)

4-pole, fixed-mounted, 3VA11/3VA12, up to 250 A
Without trip unit

Switch disconnector without SD100 trip unit

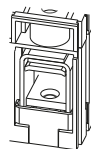

Connection with box terminal

3VA11	63	--	--	
	100	--	--	
	125	--	--	
	160	--	--	

[3VA1163-1AA46-0AA0](#)
[3VA1110-1AA46-0AA0](#)
[3VA1112-1AA46-0AA0](#)
[3VA1116-1AA46-0AA0](#)

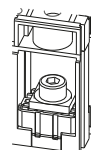

Connection with lug terminal

3VA11	63	--	--	
	100	--	--	
	125	--	--	
	160	--	--	
3VA12	250	--	--	

[3VA1163-1AA42-0AA0](#)
[3VA1110-1AA42-0AA0](#)
[3VA1112-1AA42-0AA0](#)
[3VA1116-1AA42-0AA0](#)
[3VA1225-1AA42-0AA0](#)

Note

You will find the 3VA2 molded case circuit breakers up to 630 A, IEC from [page 2/42 onwards](#).

Molded Case Circuit Breakers

3VA2 Molded Case Circuit Breakers up to 630 A, IEC **NEW**

Line protection

Selection and ordering data

PU (UNIT, SET, M) = 1

PS*/P. unit = 1 unit

PG = 1CB



Connection technology

Type

Rated current I_n

Current setting of the inverse-time delayed overload protection "L" I_r

S function (short-time delayed short-circuit protection "S") I_{sd}

Operating current of the instantaneous short-circuit protection "I" I_i

DT

I_{cu} up to 55 kA at 415 V, medium breaking capacity M
 See "Overview", p. 2/6 and 2/7
 Article No. www.siemens.com/product?ArticleNo.

Basic price per PU

3-pole, fixed-mounted, 3VA20 to 3VA24, up to 630 A Electronic trip unit



1201_18857

Line protection, ETU320 LI

With adjustable overload protection I_r and adjustable instantaneous short-circuit protection I_i

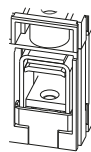

Connection with box terminal

Rated current I_n	Overload protection I_r	Overload protection t_r	Instantaneous short-circuit protection I_i
3VA20	25	10 ... 25	--
	40	16 ... 40	--
	63	25 ... 63	--
	100	40 ... 100	--
3VA21	25	10 ... 25	--
	40	16 ... 40	--
	63	25 ... 63	--
	100	40 ... 100	--
	160	63 ... 160	--

3VA2025-5HL36-0AA0
 3VA2040-5HL36-0AA0
 3VA2063-5HL36-0AA0
 3VA2010-5HL36-0AA0

3VA2125-5HL36-0AA0
 3VA2140-5HL36-0AA0
 3VA2163-5HL36-0AA0
 3VA2110-5HL36-0AA0
 3VA2116-5HL36-0AA0

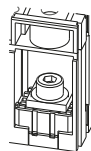
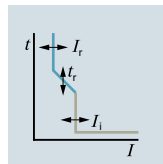

Connection with lug terminal

Rated current I_n	Overload protection I_r	Overload protection t_r	Instantaneous short-circuit protection I_i
3VA20	25	10 ... 25	--
	40	16 ... 40	--
	63	25 ... 63	--
	100	40 ... 100	--
3VA21	25	10 ... 25	--
	40	16 ... 40	--
	63	25 ... 63	--
	100	40 ... 100	--
	160	63 ... 160	--
3VA22	160	63 ... 160	--
	250	100 ... 250	--
3VA23	250	100 ... 250	--
	400	160 ... 400	--
3VA24	400	160 ... 400	--
	630	250 ... 630	--

3VA2025-5HL32-0AA0
 3VA2040-5HL32-0AA0
 3VA2063-5HL32-0AA0
 3VA2010-5HL32-0AA0

3VA2125-5HL32-0AA0
 3VA2140-5HL32-0AA0
 3VA2163-5HL32-0AA0
 3VA2110-5HL32-0AA0
 3VA2116-5HL32-0AA0

3VA2216-5HL32-0AA0
 3VA2225-5HL32-0AA0

3VA2325-5HL32-0AA0
 3VA2340-5HL32-0AA0

3VA2440-5HL32-0AA0
 3VA2463-5HL32-0AA0

¹⁾ At breaking capacity L 4400 A

PU (UNIT, SET, M) = 1

PS*/P. unit = 1 unit

PG = 1CB

Rated current I_n	DT	I_{cu} up to 85 kA at 415 V, high breaking capacity H H		DT	I_{cu} up to 110 kA at 415 V, very high breaking capacity C C		DT	I_{cu} up to 150 kA at 415 V, extremely high breaking capacity L L	
		Article No. www.siemens.com/product?Article.No.	Basic price per PU		Article No. www.siemens.com/product?Article.No.	Basic price per PU		Article No. www.siemens.com/product?Article.No.	Basic price per PU
A									

Line protection, ETU320 LI

With adjustable overload protection I_r and adjustable instantaneous short-circuit protection I_i

Connection with box terminal

25	3VA2025-6HL36-0AA0	3VA2025-7HL36-0AA0	3VA2025-8HL36-0AA0
40	3VA2040-6HL36-0AA0	3VA2040-7HL36-0AA0	3VA2040-8HL36-0AA0
63	3VA2063-6HL36-0AA0	3VA2063-7HL36-0AA0	3VA2063-8HL36-0AA0
100	3VA2010-6HL36-0AA0	3VA2010-7HL36-0AA0	3VA2010-8HL36-0AA0
25	3VA2125-6HL36-0AA0	3VA2125-7HL36-0AA0	3VA2125-8HL36-0AA0
40	3VA2140-6HL36-0AA0	3VA2140-7HL36-0AA0	3VA2140-8HL36-0AA0
63	3VA2163-6HL36-0AA0	3VA2163-7HL36-0AA0	3VA2163-8HL36-0AA0
100	3VA2110-6HL36-0AA0	3VA2110-7HL36-0AA0	3VA2110-8HL36-0AA0
160	3VA2116-6HL36-0AA0	3VA2116-7HL36-0AA0	3VA2116-8HL36-0AA0

Connection with lug terminal

25	3VA2025-6HL32-0AA0	3VA2025-7HL32-0AA0	3VA2025-8HL32-0AA0
40	3VA2040-6HL32-0AA0	3VA2040-7HL32-0AA0	3VA2040-8HL32-0AA0
63	3VA2063-6HL32-0AA0	3VA2063-7HL32-0AA0	3VA2063-8HL32-0AA0
100	3VA2010-6HL32-0AA0	3VA2010-7HL32-0AA0	3VA2010-8HL32-0AA0
25	3VA2125-6HL32-0AA0	3VA2125-7HL32-0AA0	3VA2125-8HL32-0AA0
40	3VA2140-6HL32-0AA0	3VA2140-7HL32-0AA0	3VA2140-8HL32-0AA0
63	3VA2163-6HL32-0AA0	3VA2163-7HL32-0AA0	3VA2163-8HL32-0AA0
100	3VA2110-6HL32-0AA0	3VA2110-7HL32-0AA0	3VA2110-8HL32-0AA0
160	3VA2116-6HL32-0AA0	3VA2116-7HL32-0AA0	3VA2116-8HL32-0AA0
160	3VA2216-6HL32-0AA0	3VA2216-7HL32-0AA0	3VA2216-8HL32-0AA0
250	3VA2225-6HL32-0AA0	3VA2225-7HL32-0AA0	3VA2225-8HL32-0AA0
250	3VA2325-6HL32-0AA0	3VA2325-7HL32-0AA0	3VA2325-8HL32-0AA0
400	3VA2340-6HL32-0AA0	3VA2340-7HL32-0AA0	3VA2340-8HL32-0AA0
400	3VA2440-6HL32-0AA0	3VA2440-7HL32-0AA0	3VA2440-8HL32-0AA0
630	3VA2463-6HL32-0AA0	3VA2463-7HL32-0AA0	3VA2463-8HL32-0AA0

Molded Case Circuit Breakers

3VA2 Molded Case Circuit Breakers up to 630 A, IEC **NEW**

Line protection

PU (UNIT, SET, M) = 1

PS*/P. unit = 1 unit

PG = 1CB

2



Connection technology	Type	Rated current I_n	Current setting of the inverse-time delayed overload protection "L" I_r	Operating current of the instantaneous short-circuit protection "I" I_i	Ground-fault protection G I_g	DT
		A	A	A	A	

I_{cu} up to 55 kA at 415 V, medium breaking capacity M M
 See "Overview", p. 2/6 and 2/7

Article No. www.siemens.com/product?Article No. Basic price per PU

3-pole, fixed-mounted, 3VA20 to 3VA24, up to 630 A Electronic trip unit



1201_18426

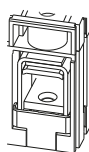
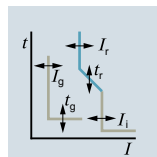

Line protection, ETU330 LIG

With adjustable overload protection I_r , adjustable instantaneous short-circuit protection I_i and adjustable ground-fault protection I_g

Connection with box terminal

3VA20	25	40	63	100	10 ... 25	16 ... 40	25 ... 63	40 ... 100	38 ... 300	60 ... 480	95 ... 756	150 ... 1200	15 ... 25	16 ... 40	16 ... 63	20 ... 100	
3VA21	25	40	63	100	160	10 ... 25	16 ... 40	25 ... 63	38 ... 300	60 ... 480	95 ... 756	150 ... 1200	240 ... 1600	15 ... 25	16 ... 40	16 ... 63	20 ... 100

[3VA2025-5HM36-0AA0](#)
[3VA2040-5HM36-0AA0](#)
[3VA2063-5HM36-0AA0](#)
[3VA2010-5HM36-0AA0](#)

[3VA2125-5HM36-0AA0](#)
[3VA2140-5HM36-0AA0](#)
[3VA2163-5HM36-0AA0](#)
[3VA2110-5HM36-0AA0](#)
[3VA2116-5HM36-0AA0](#)

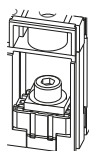

Connection with lug terminal

3VA20	25	40	63	100	160	10 ... 25	16 ... 40	25 ... 63	40 ... 100	63 ... 160	38 ... 300	60 ... 480	95 ... 756	150 ... 1200 <th>240 ... 1600 <th>15 ... 25</th> <th>16 ... 40</th> <th>16 ... 63</th> <th>20 ... 100</th> </th>	240 ... 1600 <th>15 ... 25</th> <th>16 ... 40</th> <th>16 ... 63</th> <th>20 ... 100</th>	15 ... 25	16 ... 40	16 ... 63	20 ... 100
3VA22	160	250	250	100 ... 250	250	63 ... 160	100 ... 250	375 ... 3000	600 ... 4000	375 ... 3000	600 ... 4000	945 ... 5670	126 ... 630	32 ... 160	50 ... 250	50 ... 250	80 ... 400	80 ... 400	80 ... 400
3VA23	250	400	400	100 ... 250	400	100 ... 250	160 ... 400	375 ... 3000	600 ... 4000	375 ... 3000	600 ... 4000	945 ... 5670	126 ... 630	50 ... 250	80 ... 400	80 ... 400	80 ... 400	80 ... 400	80 ... 400
3VA24	400	630	630	100 ... 250	630	160 ... 400	250 ... 630	375 ... 3000	600 ... 4000	375 ... 3000	600 ... 4000	945 ... 5670	126 ... 630	80 ... 400	80 ... 400	80 ... 400	80 ... 400	80 ... 400	80 ... 400

[3VA2025-5HM32-0AA0](#)
[3VA2040-5HM32-0AA0](#)
[3VA2063-5HM32-0AA0](#)
[3VA2010-5HM32-0AA0](#)

[3VA2125-5HM32-0AA0](#)
[3VA2140-5HM32-0AA0](#)
[3VA2163-5HM32-0AA0](#)
[3VA2110-5HM32-0AA0](#)
[3VA2116-5HM32-0AA0](#)

[3VA2216-5HM32-0AA0](#)
[3VA2225-5HM32-0AA0](#)

[3VA2325-5HM32-0AA0](#)
[3VA2340-5HM32-0AA0](#)

[3VA2440-5HM32-0AA0](#)
[3VA2463-5HM32-0AA0](#)

¹⁾ At breaking capacity L 4400 A

PU (UNIT, SET, M) = 1

PS*/P. unit = 1 unit

PG = 1CB

Rated current I_n	DT	I_{cu} up to 85 kA at 415 V, high breaking capacity H H		DT	I_{cu} up to 110 kA at 415 V, very high breaking capacity C C		DT	I_{cu} up to 150 kA at 415 V, extremely high breaking capacity L L	
		Article No. www.siemens.com/ product?Article No.	Basic price per PU		Article No. www.siemens.com/ product?Article No.	Basic price per PU		Article No. www.siemens.com/ product?Article No.	Basic price per PU
A									

Line protection, ETU330 LIG

With adjustable overload protection I_r , adjustable instantaneous short-circuit protection I_i and adjustable ground-fault protection I_g

Connection with box terminal

25	3VA2025-6HM36-0AA0	3VA2025-7HM36-0AA0	3VA2025-8HM36-0AA0
40	3VA2040-6HM36-0AA0	3VA2040-7HM36-0AA0	3VA2040-8HM36-0AA0
63	3VA2063-6HM36-0AA0	3VA2063-7HM36-0AA0	3VA2063-8HM36-0AA0
100	3VA2010-6HM36-0AA0	3VA2010-7HM36-0AA0	3VA2010-8HM36-0AA0
25	3VA2125-6HM36-0AA0	3VA2125-7HM36-0AA0	3VA2125-8HM36-0AA0
40	3VA2140-6HM36-0AA0	3VA2140-7HM36-0AA0	3VA2140-8HM36-0AA0
63	3VA2163-6HM36-0AA0	3VA2163-7HM36-0AA0	3VA2163-8HM36-0AA0
100	3VA2110-6HM36-0AA0	3VA2110-7HM36-0AA0	3VA2110-8HM36-0AA0
160	3VA2116-6HM36-0AA0	3VA2116-7HM36-0AA0	3VA2116-8HM36-0AA0

Connection with lug terminal

25	3VA2025-6HM32-0AA0	3VA2025-7HM32-0AA0	3VA2025-8HM32-0AA0
40	3VA2040-6HM32-0AA0	3VA2040-7HM32-0AA0	3VA2040-8HM32-0AA0
63	3VA2063-6HM32-0AA0	3VA2063-7HM32-0AA0	3VA2063-8HM32-0AA0
100	3VA2010-6HM32-0AA0	3VA2010-7HM32-0AA0	3VA2010-8HM32-0AA0
25	3VA2125-6HM32-0AA0	3VA2125-7HM32-0AA0	3VA2125-8HM32-0AA0
40	3VA2140-6HM32-0AA0	3VA2140-7HM32-0AA0	3VA2140-8HM32-0AA0
63	3VA2163-6HM32-0AA0	3VA2163-7HM32-0AA0	3VA2163-8HM32-0AA0
100	3VA2110-6HM32-0AA0	3VA2110-7HM32-0AA0	3VA2110-8HM32-0AA0
160	3VA2116-6HM32-0AA0	3VA2116-7HM32-0AA0	3VA2116-8HM32-0AA0
160	3VA2216-6HM32-0AA0	3VA2216-7HM32-0AA0	3VA2216-8HM32-0AA0
250	3VA2225-6HM32-0AA0	3VA2225-7HM32-0AA0	3VA2225-8HM32-0AA0
250	3VA2325-6HM32-0AA0	3VA2325-7HM32-0AA0	3VA2325-8HM32-0AA0
400	3VA2340-6HM32-0AA0	3VA2340-7HM32-0AA0	3VA2340-8HM32-0AA0
400	3VA2440-6HM32-0AA0	3VA2440-7HM32-0AA0	3VA2440-8HM32-0AA0
630	3VA2463-6HM32-0AA0	3VA2463-7HM32-0AA0	3VA2463-8HM32-0AA0

Molded Case Circuit Breakers

3VA2 Molded Case Circuit Breakers up to 630 A, IEC **NEW**

Line protection

PU (UNIT, SET, M) = 1

PS*/P. unit = 1 unit

PG = 1CB

2



Connection technology	Type	Rated current I_n	Current setting of the inverse-time delayed overload protection "L" I_r	Operating current of the instantaneous short-circuit protection "I" I_i
		A	A	A

DT	I_{cu} up to 55 kA at 415 V, medium breaking capacity M See "Overview", p. 2/6 and 2/7	
	Article No. www.siemens.com/product?Article No.	Basic price per PU

3-pole, fixed-mounted, 3VA21 to 3VA24, up to 630 A Electronic trip unit

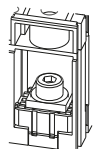
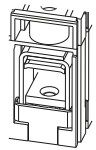
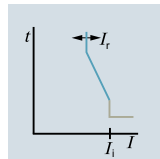

Line protection, ETU340 ELISA

With easily adjustable characteristic (characteristic form of a fuse)

Connection with box terminal

3VA21	25	10 ... 25	375
	40	16 ... 40	600
	63	25 ... 63	945
	100	40 ... 100	1500

- 3VA2125-5HK36-0AA0
- 3VA2140-5HK36-0AA0
- 3VA2163-5HK36-0AA0
- 3VA2110-5HK36-0AA0

Connection with lug terminal

3VA21	25	10 ... 25	375
	40	16 ... 40	600
	63	25 ... 63	945
	100	40 ... 100	1500
3VA22	160	63 ... 160	2400
3VA23	250	100 ... 250	3750
3VA24	400	160 ... 400	6000 ¹⁾
	500	200 ... 500	7000
	630	250 ... 630	5670

- 3VA2125-5HK32-0AA0
- 3VA2140-5HK32-0AA0
- 3VA2163-5HK32-0AA0
- 3VA2110-5HK32-0AA0
- 3VA2216-5HK32-0AA0
- 3VA2325-5HK32-0AA0
- 3VA2440-5HK32-0AA0
- 3VA2450-5HK32-0AA0
- 3VA2463-5HK32-0AA0

¹⁾ At breaking capacity L 4400 A

PU (UNIT, SET, M) = 1

PS*/P. unit = 1 unit

PG = 1CB

Rated current I_n	DT	I_{cu} up to 85 kA at 415 V, high breaking capacity H H		DT	I_{cu} up to 110 kA at 415 V, very high breaking capacity C C		DT	I_{cu} up to 150 kA at 415 V, extremely high breaking capacity L L	
		Article No. www.siemens.com/ product?Article No.	Basic price per PU		Article No. www.siemens.com/ product?Article No.	Basic price per PU		Article No. www.siemens.com/ product?Article No.	Basic price per PU
A									

2

Line protection, ETU340 ELISA

With easily adjustable characteristic (characteristic form of a fuse)

Connection with box terminal

25	3VA2125-6HK36-0AA0	3VA2125-7HK36-0AA0	3VA2125-8HK36-0AA0
40	3VA2140-6HK36-0AA0	3VA2140-7HK36-0AA0	3VA2140-8HK36-0AA0
63	3VA2163-6HK36-0AA0	3VA2163-7HK36-0AA0	3VA2163-8HK36-0AA0
100	3VA2110-6HK36-0AA0	3VA2110-7HK36-0AA0	3VA2110-8HK36-0AA0

Connection with lug terminal

25	3VA2125-6HK32-0AA0	3VA2125-7HK32-0AA0	3VA2125-8HK32-0AA0
40	3VA2140-6HK32-0AA0	3VA2140-7HK32-0AA0	3VA2140-8HK32-0AA0
63	3VA2163-6HK32-0AA0	3VA2163-7HK32-0AA0	3VA2163-8HK32-0AA0
100	3VA2110-6HK32-0AA0	3VA2110-7HK32-0AA0	3VA2110-8HK32-0AA0
160	3VA2216-6HK32-0AA0	3VA2216-7HK32-0AA0	3VA2216-8HK32-0AA0
250	3VA2325-6HK32-0AA0	3VA2325-7HK32-0AA0	3VA2325-8HK32-0AA0
400	3VA2440-6HK32-0AA0	3VA2440-7HK32-0AA0	3VA2440-8HK32-0AA0
500	3VA2450-6HK32-0AA0	3VA2450-7HK32-0AA0	3VA2450-8HK32-0AA0
630	3VA2463-6HK32-0AA0	3VA2463-7HK32-0AA0	3VA2463-8HK32-0AA0

Molded Case Circuit Breakers

3VA2 Molded Case Circuit Breakers up to 630 A, IEC **NEW**

Line protection

PU (UNIT, SET, M) = 1

PS*/P. unit = 1 unit

PG = 1CB

2



Connection technology	Type	Rated current I_n	Current setting of the inverse-time delayed overload protection "L" I_r	S function (short-time delayed short-circuit protection "S") I_{sd}	Operating current of the instantaneous short-circuit protection "I" I_i	DT	I_{cu} up to 55 kA at 415 V, medium breaking capacity M See "Overview", p. 2/6 and 2/7
		A	A	A	A		Article No. www.siemens.com/product?ArticleNo. Basic price per PU

3-pole, fixed-mounted, 3VA20 to 3VA24, up to 630 A Electronic trip unit



1201_18430

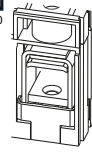
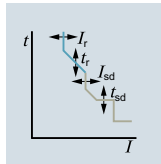

Line and generator protection, ETU350 LSI

With adjustable overload protection I_r , adjustable delayed short-circuit protection I_{sd} and fixed instantaneous short-circuit protection I_i

$I_r \times \dots$

Connection with box terminal

3VA20	25	10 ... 25	1.5 ... 10	300
	40	16 ... 40	1.5 ... 10	480
	63	25 ... 63	1.5 ... 10	756
	100	40 ... 100	1.5 ... 10	1200
3VA21	25	10 ... 25	1.5 ... 10	300
	40	16 ... 40	1.5 ... 10	480
	63	25 ... 63	1.5 ... 10	756
	100	40 ... 100	1.5 ... 10	1200
	160	63 ... 160	1.5 ... 10	1600

3VA2025-5HN36-0AA0
 3VA2040-5HN36-0AA0
 3VA2063-5HN36-0AA0
 3VA2010-5HN36-0AA0

3VA2125-5HN36-0AA0
 3VA2140-5HN36-0AA0
 3VA2163-5HN36-0AA0
 3VA2110-5HN36-0AA0
 3VA2116-5HN36-0AA0

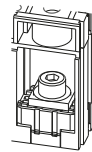

Connection with lug terminal

3VA20	25	10 ... 25	1.5 ... 10	300	3VA2025-5HN32-0AA0
	40	16 ... 40	1.5 ... 10	480	3VA2040-5HN32-0AA0
	63	25 ... 63	1.5 ... 10	756	3VA2063-5HN32-0AA0
	100	40 ... 100	1.5 ... 10	1200	3VA2010-5HN32-0AA0
3VA21	25	10 ... 25	1.5 ... 10	300	3VA2125-5HN32-0AA0
	40	16 ... 40	1.5 ... 10	480	3VA2140-5HN32-0AA0
	63	25 ... 63	1.5 ... 10	756	3VA2163-5HN32-0AA0
	100	40 ... 100	1.5 ... 10	1200	3VA2110-5HN32-0AA0
	160	63 ... 160	1.5 ... 10	1600	3VA2116-5HN32-0AA0
3VA22	160	63 ... 160	1.5 ... 10	1920	3VA2216-5HN32-0AA0
	250	100 ... 250	1.5 ... 10	2500	3VA2225-5HN32-0AA0
3VA23	250	100 ... 250	1.5 ... 10	3000	3VA2325-5HN32-0AA0
	400	160 ... 400	1.5 ... 10	4000	3VA2340-5HN32-0AA0
3VA24	400	160 ... 400	1.5 ... 10	4800 ¹⁾	3VA2440-5HN32-0AA0
	630	250 ... 630	1.5 ... 9	5670	3VA2463-5HN32-0AA0

¹⁾ At breaking capacity L 4400 A

PU (UNIT, SET, M) = 1

PS*/P. unit = 1 unit

PG = 1CB

Rated current I_n	DT	I_{cu} up to 85 kA at 415 V, high breaking capacity H H		DT	I_{cu} up to 110 kA at 415 V, very high breaking capacity C C		DT	I_{cu} up to 150 kA at 415 V, extremely high breaking capacity L L	
		Article No. www.siemens.com/ product?Article No.	Basic price per PU		Article No. www.siemens.com/ product?Article No.	Basic price per PU		Article No. www.siemens.com/ product?Article No.	Basic price per PU
A									

2

Line and generator protection, ETU350 LSI

With adjustable overload protection I_r , adjustable delayed short-circuit protection I_{sd} and fixed instantaneous short-circuit protection I_i

Connection with box terminal

Rated current	Article No.	Article No.	Article No.
25	3VA2025-6HN36-0AA0	3VA2025-7HN36-0AA0	3VA2025-8HN36-0AA0
40	3VA2040-6HN36-0AA0	3VA2040-7HN36-0AA0	3VA2040-8HN36-0AA0
63	3VA2063-6HN36-0AA0	3VA2063-7HN36-0AA0	3VA2063-8HN36-0AA0
100	3VA2010-6HN36-0AA0	3VA2010-7HN36-0AA0	3VA2010-8HN36-0AA0
25	3VA2125-6HN36-0AA0	3VA2125-7HN36-0AA0	3VA2125-8HN36-0AA0
40	3VA2140-6HN36-0AA0	3VA2140-7HN36-0AA0	3VA2140-8HN36-0AA0
63	3VA2163-6HN36-0AA0	3VA2163-7HN36-0AA0	3VA2163-8HN36-0AA0
100	3VA2110-6HN36-0AA0	3VA2110-7HN36-0AA0	3VA2110-8HN36-0AA0
160	3VA2116-6HN36-0AA0	3VA2116-7HN36-0AA0	3VA2116-8HN36-0AA0

Connection with lug terminal

Rated current	Article No.	Article No.	Article No.
25	3VA2025-6HN32-0AA0	3VA2025-7HN32-0AA0	3VA2025-8HN32-0AA0
40	3VA2040-6HN32-0AA0	3VA2040-7HN32-0AA0	3VA2040-8HN32-0AA0
63	3VA2063-6HN32-0AA0	3VA2063-7HN32-0AA0	3VA2063-8HN32-0AA0
100	3VA2010-6HN32-0AA0	3VA2010-7HN32-0AA0	3VA2010-8HN32-0AA0
25	3VA2125-6HN32-0AA0	3VA2125-7HN32-0AA0	3VA2125-8HN32-0AA0
40	3VA2140-6HN32-0AA0	3VA2140-7HN32-0AA0	3VA2140-8HN32-0AA0
63	3VA2163-6HN32-0AA0	3VA2163-7HN32-0AA0	3VA2163-8HN32-0AA0
100	3VA2110-6HN32-0AA0	3VA2110-7HN32-0AA0	3VA2110-8HN32-0AA0
160	3VA2116-6HN32-0AA0	3VA2116-7HN32-0AA0	3VA2116-8HN32-0AA0
160	3VA2216-6HN32-0AA0	3VA2216-7HN32-0AA0	3VA2216-8HN32-0AA0
250	3VA2225-6HN32-0AA0	3VA2225-7HN32-0AA0	3VA2225-8HN32-0AA0
250	3VA2325-6HN32-0AA0	3VA2325-7HN32-0AA0	3VA2325-8HN32-0AA0
400	3VA2340-6HN32-0AA0	3VA2340-7HN32-0AA0	3VA2340-8HN32-0AA0
400	3VA2440-6HN32-0AA0	3VA2440-7HN32-0AA0	3VA2440-8HN32-0AA0
630	3VA2463-6HN32-0AA0	3VA2463-7HN32-0AA0	3VA2463-8HN32-0AA0

Molded Case Circuit Breakers

3VA2 Molded Case Circuit Breakers up to 630 A, IEC **NEW**

Line protection

PU (UNIT, SET, M) = 1

PS*/P. unit = 1 unit

PG = 1CB

2



Connection technology	Type	Rated current I_n	Current setting of the inverse-time delayed overload protection "L" I_r	S function (short-time delayed short-circuit protection "S") I_{sd}	Operating current of the instantaneous short-circuit protection "I" I_i	DT	I_{cu} up to 55 kA at 415 V, medium breaking capacity M See "Overview", p. 2/6 and 2/7 M
		A	A	A	A		Article No. Basic price per PU www.siemens.com/product?Article.No.

3-pole, fixed-mounted, 3VA20 to 3VA24, up to 630 A Electronic trip unit



1201_18480

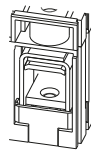
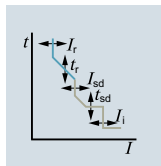

Line and generator protection, with display, ETU550 LSI

With adjustable overload protection I_r , adjustable delayed short-circuit protection I_{sd} and adjustable instantaneous short-circuit protection I_i

Connection with box terminal

3VA20	25	10 ... 25	15 ... 250	38 ... 300	3VA2025-5JP36-0AA0
	40	16 ... 40	24 ... 400	60 ... 480	3VA2040-5JP36-0AA0
	63	25 ... 63	38 ... 630	95 ... 756	3VA2063-5JP36-0AA0
	100	40 ... 100	60 ... 1000	150 ... 1200	3VA2010-5JP36-0AA0
3VA21	25	10 ... 25	15 ... 250	38 ... 300	3VA2125-5JP36-0AA0
	40	16 ... 40	24 ... 400	60 ... 480	3VA2140-5JP36-0AA0
	63	25 ... 63	38 ... 630	95 ... 756	3VA2163-5JP36-0AA0
	100	40 ... 100	60 ... 1000	150 ... 1200	3VA2110-5JP36-0AA0
	160	63 ... 160	96 ... 1600	240 ... 1600	3VA2116-5JP36-0AA0

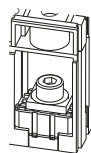

Connection with lug terminal

3VA20	25	10 ... 25	15 ... 250	38 ... 300	3VA2025-5JP32-0AA0
	40	16 ... 40	24 ... 400	60 ... 480	3VA2040-5JP32-0AA0
	63	25 ... 63	38 ... 630	95 ... 756	3VA2063-5JP32-0AA0
	100	40 ... 100	60 ... 1000	150 ... 1200	3VA2010-5JP32-0AA0
3VA21	25	10 ... 25	15 ... 250	38 ... 300	3VA2125-5JP32-0AA0
	40	16 ... 40	24 ... 400	60 ... 480	3VA2140-5JP32-0AA0
	63	25 ... 63	38 ... 630	95 ... 756	3VA2163-5JP32-0AA0
	100	40 ... 100	60 ... 1000	150 ... 1200	3VA2110-5JP32-0AA0
	160	63 ... 160	96 ... 1600	240 ... 1600	3VA2116-5JP32-0AA0
3VA22	160	63 ... 160	96 ... 1600	240 ... 1920	3VA2216-5JP32-0AA0
	250	100 ... 250	150 ... 2500	375 ... 2500	3VA2225-5JP32-0AA0
3VA23	250	100 ... 250	150 ... 2500	375 ... 3000	3VA2325-5JP32-0AA0
	400	160 ... 400	240 ... 4000	600 ... 4000	3VA2340-5JP32-0AA0
3VA24	400	160 ... 400	240 ... 4000	600 ... 6000 ¹⁾	3VA2440-5JP32-0AA0
	500	200 ... 500	300 ... 5000	750 ... 7000	3VA2450-5JP32-0AA0
	630	250 ... 630	378 ... 5670	945 ... 5670	3VA2463-5JP32-0AA0



1201_18481

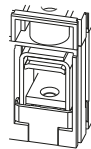
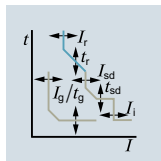

Line and generator protection, with display, ETU560 LSI

With adjustable overload protection I_r , adjustable delayed short-circuit protection I_{sd} , adjustable instantaneous short-circuit protection I_i and adjustable ground-fault protection I_g

Connection with box terminal

3VA20	25	10 ... 25	15 ... 250	38 ... 300	3VA2025-5JQ36-0AA0
	40	16 ... 40	24 ... 400	60 ... 480	3VA2040-5JQ36-0AA0
	63	25 ... 63	38 ... 630	95 ... 756	3VA2063-5JQ36-0AA0
	100	40 ... 100	60 ... 1000	150 ... 1200	3VA2010-5JQ36-0AA0
3VA21	25	10 ... 25	15 ... 250	38 ... 300	3VA2125-5JQ36-0AA0
	40	16 ... 40	24 ... 400	60 ... 480	3VA2140-5JQ36-0AA0
	63	25 ... 63	38 ... 630	95 ... 756	3VA2163-5JQ36-0AA0
	100	40 ... 100	60 ... 1000	150 ... 1200	3VA2110-5JQ36-0AA0
	160	63 ... 160	96 ... 1600	240 ... 1600	3VA2116-5JQ36-0AA0

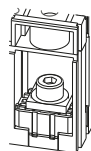

Connection with lug terminal

3VA20	25	10 ... 25	15 ... 250	38 ... 300	3VA2025-5JQ32-0AA0
	40	16 ... 40	24 ... 400	60 ... 480	3VA2040-5JQ32-0AA0
	63	25 ... 63	38 ... 630	95 ... 756	3VA2063-5JQ32-0AA0
	100	40 ... 100	60 ... 1000	150 ... 1200	3VA2010-5JQ32-0AA0
3VA21	25	10 ... 25	15 ... 250	38 ... 300	3VA2125-5JQ32-0AA0
	40	16 ... 40	24 ... 400	60 ... 480	3VA2140-5JQ32-0AA0
	63	25 ... 63	38 ... 630	95 ... 756	3VA2163-5JQ32-0AA0
	100	40 ... 100	60 ... 1000	150 ... 1200	3VA2110-5JQ32-0AA0
	160	63 ... 160	96 ... 1600	240 ... 1600	3VA2116-5JQ32-0AA0
3VA22	160	63 ... 160	96 ... 1600	240 ... 1920	3VA2216-5JQ32-0AA0
	250	100 ... 250	150 ... 2500	375 ... 2500	3VA2225-5JQ32-0AA0
3VA23	250	100 ... 250	150 ... 2500	375 ... 3000	3VA2325-5JQ32-0AA0
	400	160 ... 400	240 ... 4000	600 ... 4000	3VA2340-5JQ32-0AA0
3VA24	400	160 ... 400	240 ... 4000	600 ... 6000 ¹⁾	3VA2440-5JQ32-0AA0
	500	200 ... 500	300 ... 5000	750 ... 7000	3VA2450-5JQ32-0AA0
	630	250 ... 630	378 ... 5670	945 ... 5670	3VA2463-5JQ32-0AA0

¹⁾ At breaking capacity L 4400 A

PU (UNIT, SET, M) = 1

PS*/P. unit = 1 unit

PG = 1CB

Rated current I_n	DT	I_{cu} up to 85 kA at 415 V, high breaking capacity H H		DT	I_{cu} up to 110 kA at 415 V, very high breaking capacity C C		DT	I_{cu} up to 150 kA at 415 V, extremely high breaking capacity L L	
		Article No. www.siemens.com/ product?Article No.	Basic price per PU		Article No. www.siemens.com/ product?Article No.	Basic price per PU		Article No. www.siemens.com/ product?Article No.	Basic price per PU
A									

Line and generator protection, with display, ETU550 LSI

With adjustable overload protection I_r , adjustable delayed short-circuit protection I_{sd} and adjustable instantaneous short-circuit protection I_i

Connection with box terminal

25	3VA2025-6JP36-0AA0	3VA2025-7JP36-0AA0	3VA2025-8JP36-0AA0
40	3VA2040-6JP36-0AA0	3VA2040-7JP36-0AA0	3VA2040-8JP36-0AA0
63	3VA2063-6JP36-0AA0	3VA2063-7JP36-0AA0	3VA2063-8JP36-0AA0
100	3VA2010-6JP36-0AA0	3VA2010-7JP36-0AA0	3VA2010-8JP36-0AA0
25	3VA2125-6JP36-0AA0	3VA2125-7JP36-0AA0	3VA2125-8JP36-0AA0
40	3VA2140-6JP36-0AA0	3VA2140-7JP36-0AA0	3VA2140-8JP36-0AA0
63	3VA2163-6JP36-0AA0	3VA2163-7JP36-0AA0	3VA2163-8JP36-0AA0
100	3VA2110-6JP36-0AA0	3VA2110-7JP36-0AA0	3VA2110-8JP36-0AA0
160	3VA2116-6JP36-0AA0	3VA2116-7JP36-0AA0	3VA2116-8JP36-0AA0

Connection with lug terminal

25	3VA2025-6JP32-0AA0	3VA2025-7JP32-0AA0	3VA2025-8JP32-0AA0
40	3VA2040-6JP32-0AA0	3VA2040-7JP32-0AA0	3VA2040-8JP32-0AA0
63	3VA2063-6JP32-0AA0	3VA2063-7JP32-0AA0	3VA2063-8JP32-0AA0
100	3VA2010-6JP32-0AA0	3VA2010-7JP32-0AA0	3VA2010-8JP32-0AA0
25	3VA2125-6JP32-0AA0	3VA2125-7JP32-0AA0	3VA2125-8JP32-0AA0
40	3VA2140-6JP32-0AA0	3VA2140-7JP32-0AA0	3VA2140-8JP32-0AA0
63	3VA2163-6JP32-0AA0	3VA2163-7JP32-0AA0	3VA2163-8JP32-0AA0
100	3VA2110-6JP32-0AA0	3VA2110-7JP32-0AA0	3VA2110-8JP32-0AA0
160	3VA2116-6JP32-0AA0	3VA2116-7JP32-0AA0	3VA2116-8JP32-0AA0
160	3VA2216-6JP32-0AA0	3VA2216-7JP32-0AA0	3VA2216-8JP32-0AA0
250	3VA2225-6JP32-0AA0	3VA2225-7JP32-0AA0	3VA2225-8JP32-0AA0
250	3VA2325-6JP32-0AA0	3VA2325-7JP32-0AA0	3VA2325-8JP32-0AA0
400	3VA2340-6JP32-0AA0	3VA2340-7JP32-0AA0	3VA2340-8JP32-0AA0
400	3VA2440-6JP32-0AA0	3VA2440-7JP32-0AA0	3VA2440-8JP32-0AA0
500	3VA2450-6JP32-0AA0	3VA2450-7JP32-0AA0	--
630	3VA2463-6JP32-0AA0	3VA2463-7JP32-0AA0	3VA2463-8JP32-0AA0

Line and generator protection, with display, ETU560 LSIG

With adjustable overload protection I_r , adjustable delayed short-circuit protection I_{sd} , adjustable instantaneous short-circuit protection I_i and adjustable ground-fault protection I_g

Connection with box terminal

25	3VA2025-6JQ36-0AA0	3VA2025-7JQ36-0AA0	3VA2025-8JQ36-0AA0
40	3VA2040-6JQ36-0AA0	3VA2040-7JQ36-0AA0	3VA2040-8JQ36-0AA0
63	3VA2063-6JQ36-0AA0	3VA2063-7JQ36-0AA0	3VA2063-8JQ36-0AA0
100	3VA2010-6JQ36-0AA0	3VA2010-7JQ36-0AA0	3VA2010-8JQ36-0AA0
25	3VA2125-6JQ36-0AA0	3VA2125-7JQ36-0AA0	3VA2125-8JQ36-0AA0
40	3VA2140-6JQ36-0AA0	3VA2140-7JQ36-0AA0	3VA2140-8JQ36-0AA0
63	3VA2163-6JQ36-0AA0	3VA2163-7JQ36-0AA0	3VA2163-8JQ36-0AA0
100	3VA2110-6JQ36-0AA0	3VA2110-7JQ36-0AA0	3VA2110-8JQ36-0AA0
160	3VA2116-6JQ36-0AA0	3VA2116-7JQ36-0AA0	3VA2116-8JQ36-0AA0

Connection with lug terminal

25	3VA2025-6JQ32-0AA0	3VA2025-7JQ32-0AA0	3VA2025-8JQ32-0AA0
40	3VA2040-6JQ32-0AA0	3VA2040-7JQ32-0AA0	3VA2040-8JQ32-0AA0
63	3VA2063-6JQ32-0AA0	3VA2063-7JQ32-0AA0	3VA2063-8JQ32-0AA0
100	3VA2010-6JQ32-0AA0	3VA2010-7JQ32-0AA0	3VA2010-8JQ32-0AA0
25	3VA2125-6JQ32-0AA0	3VA2125-7JQ32-0AA0	3VA2125-8JQ32-0AA0
40	3VA2140-6JQ32-0AA0	3VA2140-7JQ32-0AA0	3VA2140-8JQ32-0AA0
63	3VA2163-6JQ32-0AA0	3VA2163-7JQ32-0AA0	3VA2163-8JQ32-0AA0
100	3VA2110-6JQ32-0AA0	3VA2110-7JQ32-0AA0	3VA2110-8JQ32-0AA0
160	3VA2116-6JQ32-0AA0	3VA2116-7JQ32-0AA0	3VA2116-8JQ32-0AA0
160	3VA2216-6JQ32-0AA0	3VA2216-7JQ32-0AA0	3VA2216-8JQ32-0AA0
250	3VA2225-6JQ32-0AA0	3VA2225-7JQ32-0AA0	3VA2225-8JQ32-0AA0
250	3VA2325-6JQ32-0AA0	3VA2325-7JQ32-0AA0	3VA2325-8JQ32-0AA0
400	3VA2340-6JQ32-0AA0	3VA2340-7JQ32-0AA0	3VA2340-8JQ32-0AA0
400	3VA2440-6JQ32-0AA0	3VA2440-7JQ32-0AA0	3VA2440-8JQ32-0AA0
500	3VA2450-6JQ32-0AA0	3VA2450-7JQ32-0AA0	--
630	3VA2463-6JQ32-0AA0	3VA2463-7JQ32-0AA0	3VA2463-8JQ32-0AA0

Molded Case Circuit Breakers

3VA2 Molded Case Circuit Breakers up to 630 A, IEC **NEW**

Line protection

PU (UNIT, SET, M) = 1

PS*/P. unit = 1 unit

PG = 1CB

2



Connection technology	Type	Rated current I_n	Current setting of the inverse-time delayed overload protection "L" I_r	S function (short-time delayed short-circuit protection "S") I_{sd}	Operating current of the instantaneous short-circuit protection "I" I_i	DT
		A	A	A	A	

I_{cu} up to 55 kA at 415 V, medium breaking capacity M M
 See "Overview", p. 2/6 and 2/7
 Article No. www.siemens.com/product?ArticleNo. Basic price per PU

3-pole, fixed-mounted, 3VA20 to 3VA24, up to 630 A Electronic trip unit



1201_18482

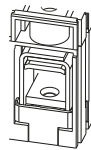
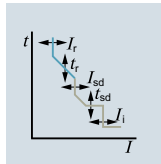

Line and generator protection, with display, with metering function, ETU850 LSI

With adjustable overload protection I_r , adjustable delayed short-circuit protection I_{sd} and adjustable instantaneous short-circuit protection I_i

Connection with box terminal

3VA20	25	10 ... 25	15 ... 250	38 ... 300	3VA2025-5KP36-0AA0
	40	16 ... 40	24 ... 400	60 ... 480	3VA2040-5KP36-0AA0
	63	25 ... 63	38 ... 630	95 ... 756	3VA2063-5KP36-0AA0
	100	40 ... 100	60 ... 1000	150 ... 1200	3VA2010-5KP36-0AA0
3VA21	25	10 ... 25	15 ... 250	38 ... 300	3VA2125-5KP36-0AA0
	40	16 ... 40	24 ... 400	60 ... 480	3VA2140-5KP36-0AA0
	63	25 ... 63	38 ... 630	95 ... 756	3VA2163-5KP36-0AA0
	100	40 ... 100	60 ... 1000	150 ... 1200	3VA2110-5KP36-0AA0
	160	63 ... 160	96 ... 1600	240 ... 1600	3VA2116-5KP36-0AA0

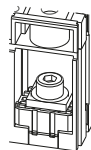

Connection with lug terminal

3VA20	25	10 ... 25	15 ... 250	38 ... 300	3VA2025-5KP32-0AA0
	40	16 ... 40	24 ... 400	60 ... 480	3VA2040-5KP32-0AA0
	63	25 ... 63	38 ... 630	95 ... 756	3VA2063-5KP32-0AA0
	100	40 ... 100	60 ... 1000	150 ... 1200	3VA2010-5KP32-0AA0
3VA21	25	10 ... 25	15 ... 250	38 ... 300	3VA2125-5KP32-0AA0
	40	16 ... 40	24 ... 400	60 ... 480	3VA2140-5KP32-0AA0
	63	25 ... 63	38 ... 630	95 ... 756	3VA2163-5KP32-0AA0
	100	40 ... 100	60 ... 1000	150 ... 1200	3VA2110-5KP32-0AA0
	160	63 ... 160	96 ... 1600	240 ... 1600	3VA2116-5KP32-0AA0
3VA22	160	63 ... 160	96 ... 1600	240 ... 1920	3VA2216-5KP32-0AA0
	250	100 ... 250	150 ... 2500	375 ... 2500	3VA2225-5KP32-0AA0
3VA23	250	100 ... 250	150 ... 2500	375 ... 3000	3VA2325-5KP32-0AA0
	400	160 ... 400	240 ... 4000	600 ... 4000	3VA2340-5KP32-0AA0
3VA24	400	160 ... 400	240 ... 4000	600 ... 6000 ¹⁾	3VA2440-5KP32-0AA0
	500	200 ... 500	300 ... 5000	750 ... 7000	3VA2450-5KP32-0AA0
	630	250 ... 630	378 ... 5670	945 ... 5670	3VA2463-5KP32-0AA0



1201_18483

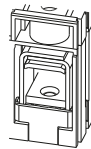
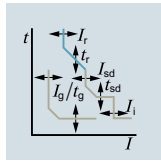

Line and generator protection, with display, with metering function, ETU860 LSI

With adjustable overload protection I_r , adjustable delayed short-circuit protection I_{sd} , adjustable instantaneous short-circuit protection I_i and adjustable ground-fault protection I_g

Connection with box terminal

3VA20	25	10 ... 25	15 ... 250	38 ... 300	3VA2025-5KQ36-0AA0
	40	16 ... 40	24 ... 400	60 ... 480	3VA2040-5KQ36-0AA0
	63	25 ... 63	38 ... 630	95 ... 756	3VA2063-5KQ36-0AA0
	100	40 ... 100	60 ... 1000	150 ... 1200	3VA2010-5KQ36-0AA0
3VA21	25	10 ... 25	15 ... 250	38 ... 300	3VA2125-5KQ36-0AA0
	40	16 ... 40	24 ... 400	60 ... 480	3VA2140-5KQ36-0AA0
	63	25 ... 63	38 ... 630	95 ... 756	3VA2163-5KQ36-0AA0
	100	40 ... 100	60 ... 1000	150 ... 1200	3VA2110-5KQ36-0AA0
	160	63 ... 160	96 ... 1600	240 ... 1600	3VA2116-5KQ36-0AA0

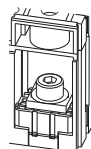

Connection with lug terminal

3VA20	25	10 ... 25	15 ... 250	38 ... 300	3VA2025-5KQ32-0AA0
	40	16 ... 40	24 ... 400	60 ... 480	3VA2040-5KQ32-0AA0
	63	25 ... 63	38 ... 630	95 ... 756	3VA2063-5KQ32-0AA0
	100	40 ... 100	60 ... 1000	150 ... 1200	3VA2010-5KQ32-0AA0
3VA21	25	10 ... 25	15 ... 250	38 ... 300	3VA2125-5KQ32-0AA0
	40	16 ... 40	24 ... 400	60 ... 480	3VA2140-5KQ32-0AA0
	63	25 ... 63	38 ... 630	95 ... 756	3VA2163-5KQ32-0AA0
	100	40 ... 100	60 ... 1000	150 ... 1200	3VA2110-5KQ32-0AA0
	160	63 ... 160	96 ... 1600	240 ... 1600	3VA2116-5KQ32-0AA0
3VA22	160	63 ... 160	96 ... 1600	240 ... 1920	3VA2216-5KQ32-0AA0
	250	100 ... 250	150 ... 2500	375 ... 2500	3VA2225-5KQ32-0AA0
3VA23	250	100 ... 250	150 ... 2500	375 ... 3000	3VA2325-5KQ32-0AA0
	400	160 ... 400	240 ... 4000	600 ... 4000	3VA2340-5KQ32-0AA0
3VA24	400	160 ... 400	240 ... 4000	600 ... 6000 ¹⁾	3VA2440-5KQ32-0AA0
	500	200 ... 500	300 ... 5000	750 ... 7000	3VA2450-5KQ32-0AA0
	630	250 ... 630	378 ... 5670	945 ... 5670	3VA2463-5KQ32-0AA0

¹⁾ At breaking capacity L 4400 A

PU (UNIT, SET, M) = 1

PS*/P. unit = 1 unit

PG = 1CB

Rated current I_n	DT	I_{cu} up to 85 kA at 415 V, high breaking capacity H H		DT	I_{cu} up to 110 kA at 415 V, very high breaking capacity C C		DT	I_{cu} up to 150 kA at 415 V, extremely high breaking capacity L L	
		Article No. www.siemens.com/product?Article No.	Basic price per PU		Article No. www.siemens.com/product?Article No.	Basic price per PU		Article No. www.siemens.com/product?Article No.	Basic price per PU
A									

Line and generator protection, with display, with metering function, ETU850 LSI

With adjustable overload protection I_r , adjustable delayed short-circuit protection I_{sd} and adjustable instantaneous short-circuit protection I_i

Connection with box terminal

25	3VA2025-6KP36-0AA0	3VA2025-7KP36-0AA0	3VA2025-8KP36-0AA0
40	3VA2040-6KP36-0AA0	3VA2040-7KP36-0AA0	3VA2040-8KP36-0AA0
63	3VA2063-6KP36-0AA0	3VA2063-7KP36-0AA0	3VA2063-8KP36-0AA0
100	3VA2010-6KP36-0AA0	3VA2010-7KP36-0AA0	3VA2010-8KP36-0AA0
25	3VA2125-6KP36-0AA0	3VA2125-7KP36-0AA0	3VA2125-8KP36-0AA0
40	3VA2140-6KP36-0AA0	3VA2140-7KP36-0AA0	3VA2140-8KP36-0AA0
63	3VA2163-6KP36-0AA0	3VA2163-7KP36-0AA0	3VA2163-8KP36-0AA0
100	3VA2110-6KP36-0AA0	3VA2110-7KP36-0AA0	3VA2110-8KP36-0AA0
160	3VA2116-6KP36-0AA0	3VA2116-7KP36-0AA0	3VA2116-8KP36-0AA0

Connection with lug terminal

25	3VA2025-6KP32-0AA0	3VA2025-7KP32-0AA0	3VA2025-8KP32-0AA0
40	3VA2040-6KP32-0AA0	3VA2040-7KP32-0AA0	3VA2040-8KP32-0AA0
63	3VA2063-6KP32-0AA0	3VA2063-7KP32-0AA0	3VA2063-8KP32-0AA0
100	3VA2010-6KP32-0AA0	3VA2010-7KP32-0AA0	3VA2010-8KP32-0AA0
25	3VA2125-6KP32-0AA0	3VA2125-7KP32-0AA0	3VA2125-8KP32-0AA0
40	3VA2140-6KP32-0AA0	3VA2140-7KP32-0AA0	3VA2140-8KP32-0AA0
63	3VA2163-6KP32-0AA0	3VA2163-7KP32-0AA0	3VA2163-8KP32-0AA0
100	3VA2110-6KP32-0AA0	3VA2110-7KP32-0AA0	3VA2110-8KP32-0AA0
160	3VA2116-6KP32-0AA0	3VA2116-7KP32-0AA0	3VA2116-8KP32-0AA0
160	3VA2216-6KP32-0AA0	3VA2216-7KP32-0AA0	3VA2216-8KP32-0AA0
250	3VA2225-6KP32-0AA0	3VA2225-7KP32-0AA0	3VA2225-8KP32-0AA0
250	3VA2325-6KP32-0AA0	3VA2325-7KP32-0AA0	3VA2325-8KP32-0AA0
400	3VA2340-6KP32-0AA0	3VA2340-7KP32-0AA0	3VA2340-8KP32-0AA0
400	3VA2440-6KP32-0AA0	3VA2440-7KP32-0AA0	3VA2440-8KP32-0AA0
500	3VA2450-6KP32-0AA0	3VA2450-7KP32-0AA0	--
630	3VA2463-6KP32-0AA0	3VA2463-7KP32-0AA0	3VA2463-8KP32-0AA0

Line and generator protection, with display, with metering function, ETU860 LSIG

With adjustable overload protection I_r , adjustable delayed short-circuit protection I_{sd} , adjustable instantaneous short-circuit protection I_i and adjustable ground-fault protection I_g

Connection with box terminal

25	3VA2025-6KQ36-0AA0	3VA2025-7KQ36-0AA0	3VA2025-8KQ36-0AA0
40	3VA2040-6KQ36-0AA0	3VA2040-7KQ36-0AA0	3VA2040-8KQ36-0AA0
63	3VA2063-6KQ36-0AA0	3VA2063-7KQ36-0AA0	3VA2063-8KQ36-0AA0
100	3VA2010-6KQ36-0AA0	3VA2010-7KQ36-0AA0	3VA2010-8KQ36-0AA0
25	3VA2125-6KQ36-0AA0	3VA2125-7KQ36-0AA0	3VA2125-8KQ36-0AA0
40	3VA2140-6KQ36-0AA0	3VA2140-7KQ36-0AA0	3VA2140-8KQ36-0AA0
63	3VA2163-6KQ36-0AA0	3VA2163-7KQ36-0AA0	3VA2163-8KQ36-0AA0
100	3VA2110-6KQ36-0AA0	3VA2110-7KQ36-0AA0	3VA2110-8KQ36-0AA0
160	3VA2116-6KQ36-0AA0	3VA2116-7KQ36-0AA0	3VA2116-8KQ36-0AA0

Connection with lug terminal

25	3VA2025-6KQ32-0AA0	3VA2025-7KQ32-0AA0	3VA2025-8KQ32-0AA0
40	3VA2040-6KQ32-0AA0	3VA2040-7KQ32-0AA0	3VA2040-8KQ32-0AA0
63	3VA2063-6KQ32-0AA0	3VA2063-7KQ32-0AA0	3VA2063-8KQ32-0AA0
100	3VA2010-6KQ32-0AA0	3VA2010-7KQ32-0AA0	3VA2010-8KQ32-0AA0
25	3VA2125-6KQ32-0AA0	3VA2125-7KQ32-0AA0	3VA2125-8KQ32-0AA0
40	3VA2140-6KQ32-0AA0	3VA2140-7KQ32-0AA0	3VA2140-8KQ32-0AA0
63	3VA2163-6KQ32-0AA0	3VA2163-7KQ32-0AA0	3VA2163-8KQ32-0AA0
100	3VA2110-6KQ32-0AA0	3VA2110-7KQ32-0AA0	3VA2110-8KQ32-0AA0
160	3VA2116-6KQ32-0AA0	3VA2116-7KQ32-0AA0	3VA2116-8KQ32-0AA0
160	3VA2216-6KQ32-0AA0	3VA2216-7KQ32-0AA0	3VA2216-8KQ32-0AA0
250	3VA2225-6KQ32-0AA0	3VA2225-7KQ32-0AA0	3VA2225-8KQ32-0AA0
250	3VA2325-6KQ32-0AA0	3VA2325-7KQ32-0AA0	3VA2325-8KQ32-0AA0
400	3VA2340-6KQ32-0AA0	3VA2340-7KQ32-0AA0	3VA2340-8KQ32-0AA0
400	3VA2440-6KQ32-0AA0	3VA2440-7KQ32-0AA0	3VA2440-8KQ32-0AA0
500	3VA2450-6KQ32-0AA0	3VA2450-7KQ32-0AA0	--
630	3VA2463-6KQ32-0AA0	3VA2463-7KQ32-0AA0	3VA2463-8KQ32-0AA0

Molded Case Circuit Breakers

3VA2 Molded Case Circuit Breakers up to 630 A, IEC **NEW**

Line protection

PU (UNIT, SET, M) = 1

PS*/P. unit = 1 unit

PG = 1CB

2



Connection technology	Type	Rated current I_n	Current setting of the inverse-time delayed overload protection "L" I_r	S function (short-time delayed short-circuit protection "S") I_{sd}	Operating current of the instantaneous short-circuit protection "I" I_i	DT	I_{cu} up to 55 kA at 415 V, medium breaking capacity M See "Overview", p. 2/6 and 2/7	Basic price per PU
		A	A	A	A			

4-pole, fixed-mounted, 3VA20 to 3VA24, up to 630 A Electronic trip unit



1201_18830

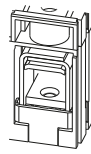
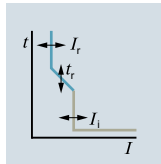

Line protection, ETU320 LI

With adjustable overload protection I_r and adjustable instantaneous short-circuit protection I_i , with neutral protection against overload and short circuit 0 % or 100 % (and 50 % with I_n 100 A and above)

Connection with box terminal

3VA20	25	10 ... 25	--	38 ... 300	3VA2025-5HL46-0AA0
	40	16 ... 40	--	60 ... 480	3VA2040-5HL46-0AA0
	63	25 ... 63	--	95 ... 756	3VA2063-5HL46-0AA0
	100	40 ... 100	--	150 ... 1200	3VA2010-5HL46-0AA0
3VA21	25	10 ... 25	--	38 ... 300	3VA2125-5HL46-0AA0
	40	16 ... 40	--	60 ... 480	3VA2140-5HL46-0AA0
	63	25 ... 63	--	95 ... 756	3VA2163-5HL46-0AA0
	100	40 ... 100	--	150 ... 1200	3VA2110-5HL46-0AA0
	160	63 ... 160	--	240 ... 1600	3VA2116-5HL46-0AA0

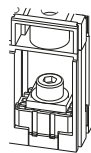

Connection with lug terminal

3VA20	25	10 ... 25	--	38 ... 300	3VA2025-5HL42-0AA0
	40	16 ... 40	--	60 ... 480	3VA2040-5HL42-0AA0
	63	25 ... 63	--	95 ... 756	3VA2063-5HL42-0AA0
	100	40 ... 100	--	150 ... 1200	3VA2010-5HL42-0AA0
3VA21	25	10 ... 25	--	38 ... 300	3VA2125-5HL42-0AA0
	40	16 ... 40	--	60 ... 480	3VA2140-5HL42-0AA0
	63	25 ... 63	--	95 ... 756	3VA2163-5HL42-0AA0
	100	40 ... 100	--	150 ... 1200	3VA2110-5HL42-0AA0
	160	63 ... 160	--	240 ... 1600	3VA2116-5HL42-0AA0
3VA22	160	63 ... 160	--	240 ... 1920	3VA2216-5HL42-0AA0
	250	100 ... 250	--	375 ... 2500	3VA2225-5HL42-0AA0
3VA23	250	100 ... 250	--	375 ... 3000	3VA2325-5HL42-0AA0
	400	160 ... 400	--	600 ... 4000	3VA2340-5HL42-0AA0
3VA24	400	160 ... 400	--	600 ... 4800 ¹⁾	3VA2440-5HL42-0AA0
	630	250 ... 630	--	945 ... 5670	3VA2463-5HL42-0AA0

¹⁾ At breaking capacity L 4400 A

PU (UNIT, SET, M) = 1

PS*/P. unit = 1 unit

PG = 1CB

Rated current I_n	DT	I_{cu} up to 85 kA at 415 V, high breaking capacity H H		DT	I_{cu} up to 110 kA at 415 V, very high breaking capacity C C		DT	I_{cu} up to 150 kA at 415 V, extremely high breaking capacity L L	
		Article No. www.siemens.com/ product?Article No.	Basic price per PU		Article No. www.siemens.com/ product?Article No.	Basic price per PU		Article No. www.siemens.com/ product?Article No.	Basic price per PU
A									

Line protection, ETU320 LI

With adjustable overload protection I_r and adjustable instantaneous short-circuit protection I_i , with neutral protection against overload and short circuit 0 % or 100 % (and 50 % with I_n 100 A and above)

Connection with box terminal

25	3VA2025-6HL46-0AA0	3VA2025-7HL46-0AA0	3VA2025-8HL46-0AA0
40	3VA2040-6HL46-0AA0	3VA2040-7HL46-0AA0	3VA2040-8HL46-0AA0
63	3VA2063-6HL46-0AA0	3VA2063-7HL46-0AA0	3VA2063-8HL46-0AA0
100	3VA2010-6HL46-0AA0	3VA2010-7HL46-0AA0	3VA2010-8HL46-0AA0
25	3VA2125-6HL46-0AA0	3VA2125-7HL46-0AA0	3VA2125-8HL46-0AA0
40	3VA2140-6HL46-0AA0	3VA2140-7HL46-0AA0	3VA2140-8HL46-0AA0
63	3VA2163-6HL46-0AA0	3VA2163-7HL46-0AA0	3VA2163-8HL46-0AA0
100	3VA2110-6HL46-0AA0	3VA2110-7HL46-0AA0	3VA2110-8HL46-0AA0
160	3VA2116-6HL46-0AA0	3VA2116-7HL46-0AA0	3VA2116-8HL46-0AA0

Connection with lug terminal

25	3VA2025-6HL42-0AA0	3VA2025-7HL42-0AA0	3VA2025-8HL42-0AA0
40	3VA2040-6HL42-0AA0	3VA2040-7HL42-0AA0	3VA2040-8HL42-0AA0
63	3VA2063-6HL42-0AA0	3VA2063-7HL42-0AA0	3VA2063-8HL42-0AA0
100	3VA2010-6HL42-0AA0	3VA2010-7HL42-0AA0	3VA2010-8HL42-0AA0
25	3VA2125-6HL42-0AA0	3VA2125-7HL42-0AA0	3VA2125-8HL42-0AA0
40	3VA2140-6HL42-0AA0	3VA2140-7HL42-0AA0	3VA2140-8HL42-0AA0
63	3VA2163-6HL42-0AA0	3VA2163-7HL42-0AA0	3VA2163-8HL42-0AA0
100	3VA2110-6HL42-0AA0	3VA2110-7HL42-0AA0	3VA2110-8HL42-0AA0
160	3VA2116-6HL42-0AA0	3VA2116-7HL42-0AA0	3VA2116-8HL42-0AA0
160	3VA2216-6HL42-0AA0	3VA2216-7HL42-0AA0	3VA2216-8HL42-0AA0
250	3VA2225-6HL42-0AA0	3VA2225-7HL42-0AA0	3VA2225-8HL42-0AA0
250	3VA2325-6HL42-0AA0	3VA2325-7HL42-0AA0	3VA2325-8HL42-0AA0
400	3VA2340-6HL42-0AA0	3VA2340-7HL42-0AA0	3VA2340-8HL42-0AA0
400	3VA2440-6HL42-0AA0	3VA2440-7HL42-0AA0	3VA2440-8HL42-0AA0
630	3VA2463-6HL42-0AA0	3VA2463-7HL42-0AA0	3VA2463-8HL42-0AA0

Molded Case Circuit Breakers

3VA2 Molded Case Circuit Breakers up to 630 A, IEC **NEW**

Line protection

PU (UNIT, SET, M) = 1

PS*/P. unit = 1 unit

PG = 1CB

2



Connection technology	Type	Rated current I_n	Current setting of the inverse-time delayed overload protection "L" I_r	Operating current of the instantaneous short-circuit protection "I" I_i	Ground-fault protection G I_g	DT	I_{cu} up to 55 kA at 415 V, medium breaking capacity M See "Overview", p. 2/6 and 2/7
		A	A	A	A		Article No. www.siemens.com/product?ArticleNo. Basic price per PU

4-pole, fixed-mounted, 3VA20 to 3VA24, up to 630 A Electronic trip unit



I201_18829

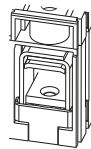
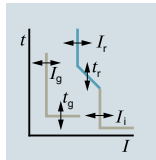

Line protection, ETU330 LIG

With adjustable overload protection I_r and adjustable instantaneous short-circuit protection I_i , with neutral protection against overload and short circuit 0 % or 100 % (and 50 % with I_n 100 A and above) and adjustable ground-fault protection I_g

Connection with box terminal

3VA20	25	10 ... 25	38 ... 300	15 ... 25	3VA2025-5HM46-0AA0 3VA2040-5HM46-0AA0 3VA2063-5HM46-0AA0 3VA2010-5HM46-0AA0
	40	16 ... 40	60 ... 480	16 ... 40	
	63	25 ... 63	95 ... 756	16 ... 63	
	100	40 ... 100	150 ... 1200	20 ... 100	
3VA21	25	10 ... 25	38 ... 300	15 ... 25	3VA2125-5HM46-0AA0 3VA2140-5HM46-0AA0 3VA2163-5HM46-0AA0 3VA2110-5HM46-0AA0 3VA2116-5HM46-0AA0
	40	16 ... 40	60 ... 480	16 ... 40	
	63	25 ... 63	95 ... 756	16 ... 63	
	100	40 ... 100	150 ... 1200	20 ... 100	
	160	63 ... 160	240 ... 1600	32 ... 160	

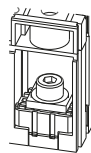

Connection with lug terminal

3VA20	25	10 ... 25	38 ... 300	15 ... 25	3VA2025-5HM42-0AA0 3VA2040-5HM42-0AA0 3VA2063-5HM42-0AA0 3VA2010-5HM42-0AA0
	40	16 ... 40	60 ... 480	16 ... 40	
	63	25 ... 63	95 ... 756	16 ... 63	
	100	40 ... 100	150 ... 1200	20 ... 100	
3VA21	25	10 ... 25	38 ... 300	15 ... 25	3VA2125-5HM42-0AA0 3VA2140-5HM42-0AA0 3VA2163-5HM42-0AA0 3VA2110-5HM42-0AA0 3VA2116-5HM42-0AA0
	40	16 ... 40	60 ... 480	16 ... 40	
	63	25 ... 63	95 ... 756	16 ... 63	
	100	40 ... 100	150 ... 1200	20 ... 100	
	160	63 ... 160	240 ... 1600	32 ... 160	
	3VA22	160	63 ... 160	240 ... 1920	
	250	100 ... 250	375 ... 2500	50 ... 250	3VA2225-5HM42-0AA0
3VA23	250	100 ... 250	375 ... 3000	50 ... 250	3VA2325-5HM42-0AA0
	400	160 ... 400	600 ... 4000	80 ... 400	3VA2340-5HM42-0AA0
3VA24	400	160 ... 400	600 ... 4800 ¹⁾	80 ... 400	3VA2440-5HM42-0AA0
	630	250 ... 630	945 ... 5670	126 ... 630	3VA2463-5HM42-0AA0

¹⁾ At breaking capacity L 4400 A

PU (UNIT, SET, M) = 1

PS*/P. unit = 1 unit

PG = 1CB

Rated current I_n	DT	I_{cu} up to 85 kA at 415 V, high breaking capacity H H		DT	I_{cu} up to 110 kA at 415 V, very high breaking capacity C C		DT	I_{cu} up to 150 kA at 415 V, extremely high breaking capacity L L	
		Article No. www.siemens.com/ product?Article No.	Basic price per PU		Article No. www.siemens.com/ product?Article No.	Basic price per PU		Article No. www.siemens.com/ product?Article No.	Basic price per PU
A									

2

Line protection, ETU330 LIG

With adjustable overload protection I_r and adjustable instantaneous short-circuit protection I_i , with neutral protection against overload and short circuit 0 % or 100 % (and 50 % with I_n 100 A and above) and adjustable ground-fault protection I_g

Connection with box terminal

25	3VA2025-6HM46-0AA0	3VA2025-7HM46-0AA0	3VA2025-8HM46-0AA0
40	3VA2040-6HM46-0AA0	3VA2040-7HM46-0AA0	3VA2040-8HM46-0AA0
63	3VA2063-6HM46-0AA0	3VA2063-7HM46-0AA0	3VA2063-8HM46-0AA0
100	3VA2010-6HM46-0AA0	3VA2010-7HM46-0AA0	3VA2010-8HM46-0AA0
25	3VA2125-6HM46-0AA0	3VA2125-7HM46-0AA0	3VA2125-8HM46-0AA0
40	3VA2140-6HM46-0AA0	3VA2140-7HM46-0AA0	3VA2140-8HM46-0AA0
63	3VA2163-6HM46-0AA0	3VA2163-7HM46-0AA0	3VA2163-8HM46-0AA0
100	3VA2110-6HM46-0AA0	3VA2110-7HM46-0AA0	3VA2110-8HM46-0AA0
160	3VA2116-6HM46-0AA0	3VA2116-7HM46-0AA0	3VA2116-8HM46-0AA0

Connection with lug terminal

25	3VA2025-6HM42-0AA0	3VA2025-7HM42-0AA0	3VA2025-8HM42-0AA0
40	3VA2040-6HM42-0AA0	3VA2040-7HM42-0AA0	3VA2040-8HM42-0AA0
63	3VA2063-6HM42-0AA0	3VA2063-7HM42-0AA0	3VA2063-8HM42-0AA0
100	3VA2010-6HM42-0AA0	3VA2010-7HM42-0AA0	3VA2010-8HM42-0AA0
25	3VA2125-6HM42-0AA0	3VA2125-7HM42-0AA0	3VA2125-8HM42-0AA0
40	3VA2140-6HM42-0AA0	3VA2140-7HM42-0AA0	3VA2140-8HM42-0AA0
63	3VA2163-6HM42-0AA0	3VA2163-7HM42-0AA0	3VA2163-8HM42-0AA0
100	3VA2110-6HM42-0AA0	3VA2110-7HM42-0AA0	3VA2110-8HM42-0AA0
160	3VA2116-6HM42-0AA0	3VA2116-7HM42-0AA0	3VA2116-8HM42-0AA0
160	3VA2216-6HM42-0AA0	3VA2216-7HM42-0AA0	3VA2216-8HM42-0AA0
250	3VA2225-6HM42-0AA0	3VA2225-7HM42-0AA0	3VA2225-8HM42-0AA0
250	3VA2325-6HM42-0AA0	3VA2325-7HM42-0AA0	3VA2325-8HM42-0AA0
400	3VA2340-6HM42-0AA0	3VA2340-7HM42-0AA0	3VA2340-8HM42-0AA0
400	3VA2440-6HM42-0AA0	3VA2440-7HM42-0AA0	3VA2440-8HM42-0AA0
630	3VA2463-6HM42-0AA0	3VA2463-7HM42-0AA0	3VA2463-8HM42-0AA0

Molded Case Circuit Breakers

3VA2 Molded Case Circuit Breakers up to 630 A, IEC **NEW**

Line protection

PU (UNIT, SET, M) = 1

PS*/P. unit = 1 unit

PG = 1CB

2



Connection technology	Type	Rated current I_n	Current setting of the inverse-time delayed overload protection "L" I_r	S function (short-time delayed short-circuit protection "S") I_{sd}	Operating current of the instantaneous short-circuit protection "I" I_i	DT
		A	A	A	A	

I_{cu} up to 55 kA at 415 V, medium breaking capacity M M
 See "Overview", p. 2/6 and 2/7
 Article No. Basic price per PU
www.siemens.com/product?ArticleNo.

4-pole, fixed-mounted, 3VA21 to 3VA24, up to 630 A Electronic trip unit



1201_18427

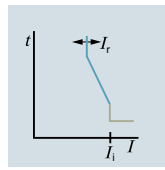

Line protection, ETU340 ELISA

With easily adjustable characteristic (characteristic form of a fuse) with "N" overload and short-circuit release 0 %, 50 % or 100 %

Connection with box terminal

3VA21	25	40	63	100	10 ... 25	16 ... 40	25 ... 63	40 ... 100	--	375	600	945	1500

[3VA2125-5HK46-0AA0](#)
[3VA2140-5HK46-0AA0](#)
[3VA2163-5HK46-0AA0](#)
[3VA2110-5HK46-0AA0](#)

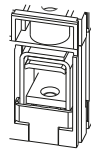

Connection with lug terminal

3VA21	25	40	63	100	10 ... 25	16 ... 40	25 ... 63	40 ... 100	--	375	600	945	1500
3VA22	160	63 ... 160	--	2400									
3VA23	250	100 ... 250	--	3750									
3VA24	400	160 ... 400	--	6000 ¹⁾									
	500	200 ... 500	--	7000									
	630	250 ... 630	--	5670									

[3VA2125-5HK42-0AA0](#)
[3VA2140-5HK42-0AA0](#)
[3VA2163-5HK42-0AA0](#)
[3VA2110-5HK42-0AA0](#)
[3VA2216-5HK42-0AA0](#)
[3VA2325-5HK42-0AA0](#)
[3VA2440-5HK42-0AA0](#)
[3VA2450-5HK42-0AA0](#)
[3VA2463-5HK42-0AA0](#)

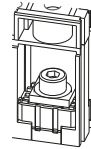

¹⁾ At breaking capacity L 4400 A

PU (UNIT, SET, M) = 1

PS*/P. unit = 1 unit

PG = 1CB

Rated current I_n	DT	I_{cu} up to 85 kA at 415 V, high breaking capacity H H		DT	I_{cu} up to 110 kA at 415 V, very high breaking capacity C C		DT	I_{cu} up to 150 kA at 415 V, extremely high breaking capacity L L	
		Article No. www.siemens.com/ product?Article No.	Basic price per PU		Article No. www.siemens.com/ product?Article No.	Basic price per PU		Article No. www.siemens.com/ product?Article No.	Basic price per PU
A									

Line protection, ETU340 ELISA

With easily adjustable characteristic (characteristic form of a fuse) with "N" overload and short-circuit release 0 %, 50 % or 100 %

Connection with box terminal			
25	3VA2125-6HK46-0AA0	3VA2125-7HK46-0AA0	3VA2125-8HK46-0AA0
40	3VA2140-6HK46-0AA0	3VA2140-7HK46-0AA0	3VA2140-8HK46-0AA0
63	3VA2163-6HK46-0AA0	3VA2163-7HK46-0AA0	3VA2163-8HK46-0AA0
100	3VA2110-6HK46-0AA0	3VA2110-7HK46-0AA0	3VA2110-8HK46-0AA0
Connection with lug terminal			
25	3VA2125-6HK42-0AA0	3VA2125-7HK42-0AA0	3VA2125-8HK42-0AA0
40	3VA2140-6HK42-0AA0	3VA2140-7HK42-0AA0	3VA2140-8HK42-0AA0
63	3VA2163-6HK42-0AA0	3VA2163-7HK42-0AA0	3VA2163-8HK42-0AA0
100	3VA2110-6HK42-0AA0	3VA2110-7HK42-0AA0	3VA2110-8HK42-0AA0
160	3VA2216-6HK42-0AA0	3VA2216-7HK42-0AA0	3VA2216-8HK42-0AA0
250	3VA2325-6HK42-0AA0	3VA2325-7HK42-0AA0	3VA2325-8HK42-0AA0
400	3VA2440-6HK42-0AA0	3VA2440-7HK42-0AA0	3VA2440-8HK42-0AA0
500	3VA2450-6HK42-0AA0	3VA2450-7HK42-0AA0	3VA2450-8HK42-0AA0
630	3VA2463-6HK42-0AA0	3VA2463-7HK42-0AA0	3VA2463-8HK42-0AA0

Molded Case Circuit Breakers

3VA2 Molded Case Circuit Breakers up to 630 A, IEC **NEW**

Line protection

PU (UNIT, SET, M) = 1

PS*/P. unit = 1 unit

PG = 1CB

2



Connection technology	Type	Rated current I_n	Current setting of the inverse-time delayed overload protection "L" I_r	S function (short-time delayed short-circuit protection "S") I_{sd}	Operating current of the instantaneous short-circuit protection "I" I_i	DT	I_{cu} up to 55 kA at 415 V, medium breaking capacity M See "Overview", p. 2/6 and 2/7
		A	A	A	A		Article No. www.siemens.com/product?ArticleNo. Basic price per PU

4-pole, fixed-mounted, 3VA20 to 3VA24, up to 630 A Electronic trip unit

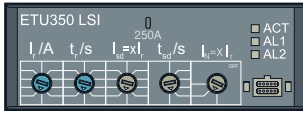

i201_18828

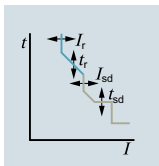

Line and generator protection, ETU350 LSI

With adjustable overload protection I_r , adjustable delayed short-circuit protection I_{sd} and fixed instantaneous short-circuit protection I_i , with neutral protection against overload and short circuit 0 % or 100 % (and 50 % with I_n 100 A and above)

$I_r \times \dots$

Connection with box terminal

3VA20	25	10 ... 25	1.5 ... 10	300	3VA2025-5HN46-0AA0
	40	16 ... 40	1.5 ... 10	480	3VA2040-5HN46-0AA0
	63	25 ... 63	1.5 ... 10	756	3VA2063-5HN46-0AA0
	100	40 ... 100	1.5 ... 10	1200	3VA2010-5HN46-0AA0
3VA21	25	10 ... 25	1.5 ... 10	300	3VA2125-5HN46-0AA0
	40	16 ... 40	1.5 ... 10	480	3VA2140-5HN46-0AA0
	63	25 ... 63	1.5 ... 10	756	3VA2163-5HN46-0AA0
	100	40 ... 100	1.5 ... 10	1200	3VA2110-5HN46-0AA0
	160	63 ... 160	1.5 ... 10	1600	3VA2116-5HN46-0AA0

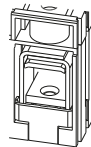

Connection with lug terminal

3VA20	25	10 ... 25	1.5 ... 10	300	3VA2025-5HN42-0AA0
	40	16 ... 40	1.5 ... 10	480	3VA2040-5HN42-0AA0
	63	25 ... 63	1.5 ... 10	756	3VA2063-5HN42-0AA0
	100	40 ... 100	1.5 ... 10	1200	3VA2010-5HN42-0AA0
3VA21	25	10 ... 25	1.5 ... 10	300	3VA2125-5HN42-0AA0
	40	16 ... 40	1.5 ... 10	480	3VA2140-5HN42-0AA0
	63	25 ... 63	1.5 ... 10	756	3VA2163-5HN42-0AA0
	100	40 ... 100	1.5 ... 10	1200	3VA2110-5HN42-0AA0
	160	63 ... 160	1.5 ... 10	1600	3VA2116-5HN42-0AA0
3VA22	160	63 ... 160	1.5 ... 10	1920	3VA2216-5HN42-0AA0
	250	100 ... 250	1.5 ... 10	2500	3VA2225-5HN42-0AA0
3VA23	250	100 ... 250	1.5 ... 10	3000	3VA2325-5HN42-0AA0
	400	160 ... 400	1.5 ... 10	4000	3VA2340-5HN42-0AA0
3VA24	400	160 ... 400	1.5 ... 10	4800 ¹⁾	3VA2440-5HN42-0AA0
	630	250 ... 630	1.5 ... 9	5670	3VA2463-5HN42-0AA0

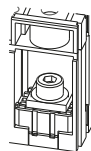

¹⁾ At breaking capacity L 4400 A

PU (UNIT, SET, M) = 1

PS*/P. unit = 1 unit

PG = 1CB

Rated current I_n	DT	I_{cu} up to 85 kA at 415 V, high breaking capacity H H		DT	I_{cu} up to 110 kA at 415 V, very high breaking capacity C C		DT	I_{cu} up to 150 kA at 415 V, extremely high breaking capacity L L	
		Article No. www.siemens.com/product?Article No.	Basic price per PU		Article No. www.siemens.com/product?Article No.	Basic price per PU		Article No. www.siemens.com/product?Article No.	Basic price per PU
A									

Line and generator protection, ETU350 LSI

With adjustable overload protection I_n , adjustable delayed short-circuit protection I_{sd} and fixed instantaneous short-circuit protection I_i , with neutral protection against overload and short circuit 0 % or 100 % (and 50 % with I_n 100 A and above)

Connection with box terminal

25	3VA2025-6HN46-0AA0	3VA2025-7HN46-0AA0	3VA2025-8HN46-0AA0
40	3VA2040-6HN46-0AA0	3VA2040-7HN46-0AA0	3VA2040-8HN46-0AA0
63	3VA2063-6HN46-0AA0	3VA2063-7HN46-0AA0	3VA2063-8HN46-0AA0
100	3VA2010-6HN46-0AA0	3VA2010-7HN46-0AA0	3VA2010-8HN46-0AA0
25	3VA2125-6HN46-0AA0	3VA2125-7HN46-0AA0	3VA2125-8HN46-0AA0
40	3VA2140-6HN46-0AA0	3VA2140-7HN46-0AA0	3VA2140-8HN46-0AA0
63	3VA2163-6HN46-0AA0	3VA2163-7HN46-0AA0	3VA2163-8HN46-0AA0
100	3VA2110-6HN46-0AA0	3VA2110-7HN46-0AA0	3VA2110-8HN46-0AA0
160	3VA2116-6HN46-0AA0	3VA2116-7HN46-0AA0	3VA2116-8HN46-0AA0

Connection with lug terminal

25	3VA2025-6HN42-0AA0	3VA2025-7HN42-0AA0	3VA2025-8HN42-0AA0
40	3VA2040-6HN42-0AA0	3VA2040-7HN42-0AA0	3VA2040-8HN42-0AA0
63	3VA2063-6HN42-0AA0	3VA2063-7HN42-0AA0	3VA2063-8HN42-0AA0
100	3VA2010-6HN42-0AA0	3VA2010-7HN42-0AA0	3VA2010-8HN42-0AA0
25	3VA2125-6HN42-0AA0	3VA2125-7HN42-0AA0	3VA2125-8HN42-0AA0
40	3VA2140-6HN42-0AA0	3VA2140-7HN42-0AA0	3VA2140-8HN42-0AA0
63	3VA2163-6HN42-0AA0	3VA2163-7HN42-0AA0	3VA2163-8HN42-0AA0
100	3VA2110-6HN42-0AA0	3VA2110-7HN42-0AA0	3VA2110-8HN42-0AA0
160	3VA2116-6HN42-0AA0	3VA2116-7HN42-0AA0	3VA2116-8HN42-0AA0
160	3VA2216-6HN42-0AA0	3VA2216-7HN42-0AA0	3VA2216-8HN42-0AA0
250	3VA2225-6HN42-0AA0	3VA2225-7HN42-0AA0	3VA2225-8HN42-0AA0
250	3VA2325-6HN42-0AA0	3VA2325-7HN42-0AA0	3VA2325-8HN42-0AA0
400	3VA2340-6HN42-0AA0	3VA2340-7HN42-0AA0	3VA2340-8HN42-0AA0
400	3VA2440-6HN42-0AA0	3VA2440-7HN42-0AA0	3VA2440-8HN42-0AA0
630	3VA2463-6HN42-0AA0	3VA2463-7HN42-0AA0	3VA2463-8HN42-0AA0

Molded Case Circuit Breakers

3VA2 Molded Case Circuit Breakers up to 630 A, IEC **NEW**

Line protection

PU (UNIT, SET, M) = 1

PS*/P. unit = 1 unit

PG = 1CB

2



Connection technology	Type	Rated current I_n	Current setting of the inverse-time delayed overload protection "L" I_r	S function (short-time delayed short-circuit protection "S") I_{sd}	Operating current of the instantaneous short-circuit protection "I" I_i	DT
		A	A	A	A	

I_{cu} up to 55 kA at 415 V, medium breaking capacity M M

See "Overview", p. 2/6 and 2/7

Article No. www.siemens.com/product?ArticleNo. Basic price per PU

4-pole, fixed-mounted, 3VA20 to 3VA24, up to 630 A Electronic trip unit



i201_18480

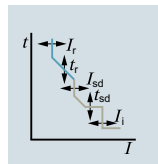

Line and generator protection, with display, ETU550 LSI

With adjustable overload protection I_r , adjustable delayed short-circuit protection I_{sd} and fixed instantaneous short-circuit protection I_i , with neutral protection against overload and short circuit from 20 %/40 % to 100 %/160 %

Connection with box terminal

Rated current I_n	I_r	I_{sd}	I_i	Article No.
3VA20	25	10 ... 25	15 ... 250	3VA2025-5JP46-0AA0
	40	16 ... 40	24 ... 400	3VA2040-5JP46-0AA0
	63	25 ... 63	38 ... 630	3VA2063-5JP46-0AA0
	100	40 ... 100	60 ... 1000	3VA2010-5JP46-0AA0
3VA21	25	10 ... 25	15 ... 250	3VA2125-5JP46-0AA0
	40	16 ... 40	24 ... 400	3VA2140-5JP46-0AA0
	63	25 ... 63	38 ... 630	3VA2163-5JP46-0AA0
	100	40 ... 100	60 ... 1000	3VA2110-5JP46-0AA0
	160	63 ... 160	96 ... 1600	3VA2116-5JP46-0AA0

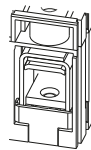

Connection with lug terminal

Rated current I_n	I_r	I_{sd}	I_i	Article No.
3VA20	25	10 ... 25	15 ... 250	3VA2025-5JP42-0AA0
	40	16 ... 40	24 ... 400	3VA2040-5JP42-0AA0
	63	25 ... 63	38 ... 630	3VA2063-5JP42-0AA0
	100	40 ... 100	60 ... 1000	3VA2010-5JP42-0AA0
3VA21	25	10 ... 25	15 ... 250	3VA2125-5JP42-0AA0
	40	16 ... 40	24 ... 400	3VA2140-5JP42-0AA0
	63	25 ... 63	38 ... 630	3VA2163-5JP42-0AA0
	100	40 ... 100	60 ... 1000	3VA2110-5JP42-0AA0
	160	63 ... 160	96 ... 1600	3VA2116-5JP42-0AA0
3VA22	160	63 ... 160	96 ... 1600	3VA2216-5JP42-0AA0
	250	100 ... 250	150 ... 2500	3VA2225-5JP42-0AA0
3VA23	250	100 ... 250	150 ... 2500	3VA2325-5JP42-0AA0
	400	160 ... 400	240 ... 4000	3VA2340-5JP42-0AA0
3VA24	400	160 ... 400	240 ... 4000	3VA2440-5JP42-0AA0
	500	200 ... 500	300 ... 5000	3VA2450-5JP42-0AA0
	630	250 ... 630	378 ... 5670	3VA2463-5JP42-0AA0

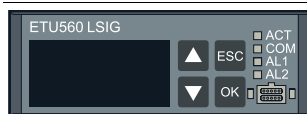
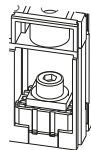

i201_18481

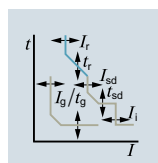

Line and generator protection, with display, ETU560 LSI

With adjustable overload protection I_r , adjustable delayed short-circuit protection I_{sd} and fixed instantaneous short-circuit protection I_i , with neutral protection against overload and short circuit from 20 %/40 % to 100 %/160 % and adjustable ground-fault protection I_g

Connection with box terminal

Rated current I_n	I_r	I_{sd}	I_i	Article No.
3VA20	25	10 ... 25	15 ... 250	3VA2025-5JQ46-0AA0
	40	16 ... 40	24 ... 400	3VA2040-5JQ46-0AA0
	63	25 ... 63	38 ... 630	3VA2063-5JQ46-0AA0
	100	40 ... 100	60 ... 1000	3VA2010-5JQ46-0AA0
3VA21	25	10 ... 25	15 ... 250	3VA2125-5JQ46-0AA0
	40	16 ... 40	24 ... 400	3VA2140-5JQ46-0AA0
	63	25 ... 63	38 ... 630	3VA2163-5JQ46-0AA0
	100	40 ... 100	60 ... 1000	3VA2110-5JQ46-0AA0
	160	63 ... 160	96 ... 1600	3VA2116-5JQ46-0AA0

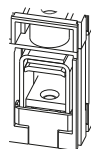

Connection with lug terminal

Rated current I_n	I_r	I_{sd}	I_i	Article No.
3VA20	25	10 ... 25	15 ... 250	3VA2025-5JQ42-0AA0
	40	16 ... 40	24 ... 400	3VA2040-5JQ42-0AA0
	63	25 ... 63	38 ... 630	3VA2063-5JQ42-0AA0
	100	40 ... 100	60 ... 1000	3VA2010-5JQ42-0AA0
3VA21	25	10 ... 25	15 ... 250	3VA2125-5JQ42-0AA0
	40	16 ... 40	24 ... 400	3VA2140-5JQ42-0AA0
	63	25 ... 63	38 ... 630	3VA2163-5JQ42-0AA0
	100	40 ... 100	60 ... 1000	3VA2110-5JQ42-0AA0
	160	63 ... 160	96 ... 1600	3VA2116-5JQ42-0AA0
3VA22	160	63 ... 160	96 ... 1600	3VA2216-5JQ42-0AA0
	250	100 ... 250	150 ... 2500	3VA2225-5JQ42-0AA0
3VA23	250	100 ... 250	150 ... 2500	3VA2325-5JQ42-0AA0
	400	160 ... 400	240 ... 4000	3VA2340-5JQ42-0AA0
3VA24	400	160 ... 400	240 ... 4000	3VA2440-5JQ42-0AA0
	500	200 ... 500	300 ... 5000	3VA2450-5JQ42-0AA0
	630	250 ... 630	378 ... 5670	3VA2463-5JQ42-0AA0

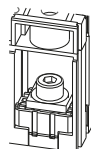

¹⁾ At breaking capacity L 4400 A

PU (UNIT, SET, M) = 1

PS*/P. unit = 1 unit

PG = 1CB

Rated current I_n	DT	I_{cu} up to 85 kA at 415 V, high breaking capacity H H		DT	I_{cu} up to 110 kA at 415 V, very high breaking capacity C C		DT	I_{cu} up to 150 kA at 415 V, extremely high breaking capacity L L	
		Article No. www.siemens.com/ product?Article No.	Basic price per PU		Article No. www.siemens.com/ product?Article No.	Basic price per PU		Article No. www.siemens.com/ product?Article No.	Basic price per PU
A									

Line and generator protection, with display, ETU550 LSI

With adjustable overload protection I_r , adjustable delayed short-circuit protection I_{sd} and fixed instantaneous short-circuit protection I_i , with neutral protection against overload and short circuit from 20 %/40 % to 100 %/160 %

Connection with box terminal

25	3VA2025-6JP46-0AA0	3VA2025-7JP46-0AA0	3VA2025-8JP46-0AA0
40	3VA2040-6JP46-0AA0	3VA2040-7JP46-0AA0	3VA2040-8JP46-0AA0
63	3VA2063-6JP46-0AA0	3VA2063-7JP46-0AA0	3VA2063-8JP46-0AA0
100	3VA2010-6JP46-0AA0	3VA2010-7JP46-0AA0	3VA2010-8JP46-0AA0
25	3VA2125-6JP46-0AA0	3VA2125-7JP46-0AA0	3VA2125-8JP46-0AA0
40	3VA2140-6JP46-0AA0	3VA2140-7JP46-0AA0	3VA2140-8JP46-0AA0
63	3VA2163-6JP46-0AA0	3VA2163-7JP46-0AA0	3VA2163-8JP46-0AA0
100	3VA2110-6JP46-0AA0	3VA2110-7JP46-0AA0	3VA2110-8JP46-0AA0
160	3VA2116-6JP46-0AA0	3VA2116-7JP46-0AA0	3VA2116-8JP46-0AA0

Connection with lug terminal

25	3VA2025-6JP42-0AA0	3VA2025-7JP42-0AA0	3VA2025-8JP42-0AA0
40	3VA2040-6JP42-0AA0	3VA2040-7JP42-0AA0	3VA2040-8JP42-0AA0
63	3VA2063-6JP42-0AA0	3VA2063-7JP42-0AA0	3VA2063-8JP42-0AA0
100	3VA2010-6JP42-0AA0	3VA2010-7JP42-0AA0	3VA2010-8JP42-0AA0
25	3VA2125-6JP42-0AA0	3VA2125-7JP42-0AA0	3VA2125-8JP42-0AA0
40	3VA2140-6JP42-0AA0	3VA2140-7JP42-0AA0	3VA2140-8JP42-0AA0
63	3VA2163-6JP42-0AA0	3VA2163-7JP42-0AA0	3VA2163-8JP42-0AA0
100	3VA2110-6JP42-0AA0	3VA2110-7JP42-0AA0	3VA2110-8JP42-0AA0
160	3VA2116-6JP42-0AA0	3VA2116-7JP42-0AA0	3VA2116-8JP42-0AA0
160	3VA2216-6JP42-0AA0	3VA2216-7JP42-0AA0	3VA2216-8JP42-0AA0
250	3VA2225-6JP42-0AA0	3VA2225-7JP42-0AA0	3VA2225-8JP42-0AA0
250	3VA2325-6JP42-0AA0	3VA2325-7JP42-0AA0	3VA2325-8JP42-0AA0
400	3VA2340-6JP42-0AA0	3VA2340-7JP42-0AA0	3VA2340-8JP42-0AA0
400	3VA2440-6JP42-0AA0	3VA2440-7JP42-0AA0	3VA2440-8JP42-0AA0
500	3VA2450-6JP42-0AA0	3VA2450-7JP42-0AA0	--
630	3VA2463-6JP42-0AA0	3VA2463-7JP42-0AA0	3VA2463-8JP42-0AA0

Line and generator protection, with display, ETU560 LSIg

With adjustable overload protection I_r , adjustable delayed short-circuit protection I_{sd} and fixed instantaneous short-circuit protection I_i , with neutral protection against overload and short circuit from 20 %/40 % to 100 %/160 % and adjustable ground-fault protection I_g

Connection with box terminal

25	3VA2025-6JQ46-0AA0	3VA2025-7JQ46-0AA0	3VA2025-8JQ46-0AA0
40	3VA2040-6JQ46-0AA0	3VA2040-7JQ46-0AA0	3VA2040-8JQ46-0AA0
63	3VA2063-6JQ46-0AA0	3VA2063-7JQ46-0AA0	3VA2063-8JQ46-0AA0
100	3VA2010-6JQ46-0AA0	3VA2010-7JQ46-0AA0	3VA2010-8JQ46-0AA0
25	3VA2125-6JQ46-0AA0	3VA2125-7JQ46-0AA0	3VA2125-8JQ46-0AA0
40	3VA2140-6JQ46-0AA0	3VA2140-7JQ46-0AA0	3VA2140-8JQ46-0AA0
63	3VA2163-6JQ46-0AA0	3VA2163-7JQ46-0AA0	3VA2163-8JQ46-0AA0
100	3VA2110-6JQ46-0AA0	3VA2110-7JQ46-0AA0	3VA2110-8JQ46-0AA0
160	3VA2116-6JQ46-0AA0	3VA2116-7JQ46-0AA0	3VA2116-8JQ46-0AA0

Connection with lug terminal

25	3VA2025-6JQ42-0AA0	3VA2025-7JQ42-0AA0	3VA2025-8JQ42-0AA0
40	3VA2040-6JQ42-0AA0	3VA2040-7JQ42-0AA0	3VA2040-8JQ42-0AA0
63	3VA2063-6JQ42-0AA0	3VA2063-7JQ42-0AA0	3VA2063-8JQ42-0AA0
100	3VA2010-6JQ42-0AA0	3VA2010-7JQ42-0AA0	3VA2010-8JQ42-0AA0
25	3VA2125-6JQ42-0AA0	3VA2125-7JQ42-0AA0	3VA2125-8JQ42-0AA0
40	3VA2140-6JQ42-0AA0	3VA2140-7JQ42-0AA0	3VA2140-8JQ42-0AA0
63	3VA2163-6JQ42-0AA0	3VA2163-7JQ42-0AA0	3VA2163-8JQ42-0AA0
100	3VA2110-6JQ42-0AA0	3VA2110-7JQ42-0AA0	3VA2110-8JQ42-0AA0
160	3VA2116-6JQ42-0AA0	3VA2116-7JQ42-0AA0	3VA2116-8JQ42-0AA0
160	3VA2216-6JQ42-0AA0	3VA2216-7JQ42-0AA0	3VA2216-8JQ42-0AA0
250	3VA2225-6JQ42-0AA0	3VA2225-7JQ42-0AA0	3VA2225-8JQ42-0AA0
250	3VA2325-6JQ42-0AA0	3VA2325-7JQ42-0AA0	3VA2325-8JQ42-0AA0
400	3VA2340-6JQ42-0AA0	3VA2340-7JQ42-0AA0	3VA2340-8JQ42-0AA0
400	3VA2440-6JQ42-0AA0	3VA2440-7JQ42-0AA0	3VA2440-8JQ42-0AA0
500	3VA2450-6JQ42-0AA0	3VA2450-7JQ42-0AA0	--
630	3VA2463-6JQ42-0AA0	3VA2463-7JQ42-0AA0	3VA2463-8JQ42-0AA0

Molded Case Circuit Breakers

3VA2 Molded Case Circuit Breakers up to 630 A, IEC **NEW**

Line protection

PU (UNIT, SET, M) = 1

PS*/P. unit = 1 unit

PG = 1CB



Connection technology	Type	Rated current I_n	Current setting of the inverse-time delayed overload protection "L" I_r	S function (short-time delayed short-circuit protection "S") I_{sd}	Operating current of the instantaneous short-circuit protection "I" I_i	DT
		A	A	A	A	

I_{cu} up to 55 kA at 415 V, medium breaking capacity M **(M)**
 See "Overview", p. 2/6 and 2/7
 Article No. www.siemens.com/product?Article No. Basic price per PU

4-pole, fixed-mounted, 3VA20 to 3VA24, up to 630 A Electronic trip unit



i201_18482

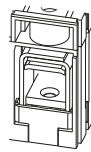
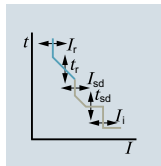

Line and generator protection, with display, with metering function, ETU850 LSI

With adjustable overload protection I_r , adjustable delayed short-circuit protection I_{sd} and fixed instantaneous short-circuit protection I_i , with neutral protection against overload and short circuit from 20 %/40 % to 100 %/160 %

Connection with box terminal

Model	Rated current I_n	I_r	I_{sd}	I_i	Article No.
3VA20	25	10 ... 25	15 ... 250	38 ... 300	3VA2025-5KP46-0AA0
	40	16 ... 40	24 ... 400	60 ... 480	3VA2040-5KP46-0AA0
	63	25 ... 63	38 ... 630	95 ... 756	3VA2063-5KP46-0AA0
	100	40 ... 100	60 ... 1000	150 ... 1200	3VA2010-5KP46-0AA0
3VA21	25	10 ... 25	15 ... 250	38 ... 300	3VA2125-5KP46-0AA0
	40	16 ... 40	24 ... 400	60 ... 480	3VA2140-5KP46-0AA0
	63	25 ... 63	38 ... 630	95 ... 756	3VA2163-5KP46-0AA0
	100	40 ... 100	60 ... 1000	150 ... 1200	3VA2110-5KP46-0AA0
	160	63 ... 160	96 ... 1600	240 ... 1600	3VA2116-5KP46-0AA0

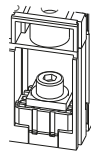

Connection with lug terminal

Model	Rated current I_n	I_r	I_{sd}	I_i	Article No.
3VA20	25	10 ... 25	15 ... 250	38 ... 300	3VA2025-5KP42-0AA0
	40	16 ... 40	24 ... 400	60 ... 480	3VA2040-5KP42-0AA0
	63	25 ... 63	38 ... 630	95 ... 756	3VA2063-5KP42-0AA0
	100	40 ... 100	60 ... 1000	150 ... 1200	3VA2010-5KP42-0AA0
3VA21	25	10 ... 25	15 ... 250	38 ... 300	3VA2125-5KP42-0AA0
	40	16 ... 40	24 ... 400	60 ... 480	3VA2140-5KP42-0AA0
	63	25 ... 63	38 ... 630	95 ... 756	3VA2163-5KP42-0AA0
	100	40 ... 100	60 ... 1000	150 ... 1200	3VA2110-5KP42-0AA0
	160	63 ... 160	96 ... 1600	240 ... 1600	3VA2116-5KP42-0AA0
3VA22	160	63 ... 160	96 ... 1600	240 ... 1920	3VA2216-5KP42-0AA0
	250	100 ... 250	150 ... 2500	375 ... 2500	3VA2225-5KP42-0AA0
3VA23	250	100 ... 250	150 ... 2500	375 ... 3000	3VA2325-5KP42-0AA0
	400	160 ... 400	240 ... 4000	600 ... 4000	3VA2340-5KP42-0AA0
3VA24	400	160 ... 400	240 ... 4000	600 ... 6000 ¹⁾	3VA2440-5KP42-0AA0
	500	200 ... 500	300 ... 5000	750 ... 7000	3VA2450-5KP42-0AA0
	630	250 ... 630	378 ... 5670	945 ... 5670	3VA2463-5KP42-0AA0

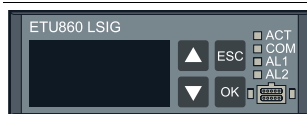

i201_18483

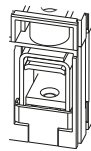
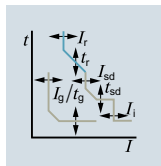

Line and generator protection, with display, with metering function, ETU860 LSIG

With adjustable overload protection I_r , adjustable delayed short-circuit protection I_{sd} and fixed instantaneous short-circuit protection I_i , with neutral protection against overload and short circuit from 20 %/40 % to 100 %/160 % and adjustable ground-fault protection I_g

Connection with box terminal

Model	Rated current I_n	I_r	I_{sd}	I_i	Article No.
3VA20	25	10 ... 25	15 ... 250	38 ... 300	3VA2025-5KQ46-0AA0
	40	16 ... 40	24 ... 400	60 ... 480	3VA2040-5KQ46-0AA0
	63	25 ... 63	38 ... 630	95 ... 756	3VA2063-5KQ46-0AA0
	100	40 ... 100	60 ... 1000	150 ... 1200	3VA2010-5KQ46-0AA0
3VA21	25	10 ... 25	15 ... 250	38 ... 300	3VA2125-5KQ46-0AA0
	40	16 ... 40	24 ... 400	60 ... 480	3VA2140-5KQ46-0AA0
	63	25 ... 63	38 ... 630	95 ... 756	3VA2163-5KQ46-0AA0
	100	40 ... 100	60 ... 1000	150 ... 1200	3VA2110-5KQ46-0AA0
	160	63 ... 160	96 ... 1600	240 ... 1600	3VA2116-5KQ46-0AA0

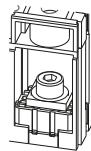

Connection with lug terminal

Model	Rated current I_n	I_r	I_{sd}	I_i	Article No.
3VA20	25	10 ... 25	15 ... 250	38 ... 300	3VA2025-5KQ42-0AA0
	40	16 ... 40	24 ... 400	60 ... 480	3VA2040-5KQ42-0AA0
	63	25 ... 63	38 ... 630	95 ... 756	3VA2063-5KQ42-0AA0
	100	40 ... 100	60 ... 1000	150 ... 1200	3VA2010-5KQ42-0AA0
3VA21	25	10 ... 25	15 ... 250	38 ... 300	3VA2125-5KQ42-0AA0
	40	16 ... 40	24 ... 400	60 ... 480	3VA2140-5KQ42-0AA0
	63	25 ... 63	38 ... 630	95 ... 756	3VA2163-5KQ42-0AA0
	100	40 ... 100	60 ... 1000	150 ... 1200	3VA2110-5KQ42-0AA0
	160	63 ... 160	96 ... 1600	240 ... 1600	3VA2116-5KQ42-0AA0
3VA22	160	63 ... 160	96 ... 1600	240 ... 1920	3VA2216-5KQ42-0AA0
	250	100 ... 250	150 ... 2500	375 ... 2500	3VA2225-5KQ42-0AA0
3VA23	250	100 ... 250	150 ... 2500	375 ... 3000	3VA2325-5KQ42-0AA0
	400	160 ... 400	240 ... 4000	600 ... 4000	3VA2340-5KQ42-0AA0
3VA24	400	160 ... 400	240 ... 4000	600 ... 6000 ¹⁾	3VA2440-5KQ42-0AA0
	500	200 ... 500	300 ... 5000	750 ... 7000	3VA2450-5KQ42-0AA0
	630	250 ... 630	378 ... 5670	945 ... 5670	3VA2463-5KQ42-0AA0

¹⁾ At breaking capacity L 4400 A

PU (UNIT, SET, M) = 1

PS*/P. unit = 1 unit

PG = 1CB

Rated current I_n	DT	I_{cu} up to 85 kA at 415 V, high breaking capacity H H	DT	I_{cu} up to 110 kA at 415 V, very high breaking capacity C C	DT	I_{cu} up to 150 kA at 415 V, extremely high breaking capacity L L	
		Article No. www.siemens.com/ product?Article No.	Basic price per PU	Article No. www.siemens.com/ product?Article No.	Basic price per PU	Article No. www.siemens.com/ product?Article No.	Basic price per PU
A							

2

Line and generator protection, with display, with metering function, ETU850 LSI

With adjustable overload protection I_r , adjustable delayed short-circuit protection I_{sd}
and fixed instantaneous short-circuit protection I_i ,
with neutral protection against overload and short circuit from 20 %/40 % to 100 %/160 %

Connection with box terminal

25	3VA2025-6KP46-0AA0	3VA2025-7KP46-0AA0	3VA2025-8KP46-0AA0
40	3VA2040-6KP46-0AA0	3VA2040-7KP46-0AA0	3VA2040-8KP46-0AA0
63	3VA2063-6KP46-0AA0	3VA2063-7KP46-0AA0	3VA2063-8KP46-0AA0
100	3VA2010-6KP46-0AA0	3VA2010-7KP46-0AA0	3VA2010-8KP46-0AA0
25	3VA2125-6KP46-0AA0	3VA2125-7KP46-0AA0	3VA2125-8KP46-0AA0
40	3VA2140-6KP46-0AA0	3VA2140-7KP46-0AA0	3VA2140-8KP46-0AA0
63	3VA2163-6KP46-0AA0	3VA2163-7KP46-0AA0	3VA2163-8KP46-0AA0
100	3VA2110-6KP46-0AA0	3VA2110-7KP46-0AA0	3VA2110-8KP46-0AA0
160	3VA2116-6KP46-0AA0	3VA2116-7KP46-0AA0	3VA2116-8KP46-0AA0

Connection with lug terminal

25	3VA2025-6KP42-0AA0	3VA2025-7KP42-0AA0	3VA2025-8KP42-0AA0
40	3VA2040-6KP42-0AA0	3VA2040-7KP42-0AA0	3VA2040-8KP42-0AA0
63	3VA2063-6KP42-0AA0	3VA2063-7KP42-0AA0	3VA2063-8KP42-0AA0
100	3VA2010-6KP42-0AA0	3VA2010-7KP42-0AA0	3VA2010-8KP42-0AA0
25	3VA2125-6KP42-0AA0	3VA2125-7KP42-0AA0	3VA2125-8KP42-0AA0
40	3VA2140-6KP42-0AA0	3VA2140-7KP42-0AA0	3VA2140-8KP42-0AA0
63	3VA2163-6KP42-0AA0	3VA2163-7KP42-0AA0	3VA2163-8KP42-0AA0
100	3VA2110-6KP42-0AA0	3VA2110-7KP42-0AA0	3VA2110-8KP42-0AA0
160	3VA2116-6KP42-0AA0	3VA2116-7KP42-0AA0	3VA2116-8KP42-0AA0
160	3VA2216-6KP42-0AA0	3VA2216-7KP42-0AA0	3VA2216-8KP42-0AA0
250	3VA2225-6KP42-0AA0	3VA2225-7KP42-0AA0	3VA2225-8KP42-0AA0
250	3VA2325-6KP42-0AA0	3VA2325-7KP42-0AA0	3VA2325-8KP42-0AA0
400	3VA2340-6KP42-0AA0	3VA2340-7KP42-0AA0	3VA2340-8KP42-0AA0
400	3VA2440-6KP42-0AA0	3VA2440-7KP42-0AA0	3VA2440-8KP42-0AA0
500	3VA2450-6KP42-0AA0	3VA2450-7KP42-0AA0	--
630	3VA2463-6KP42-0AA0	3VA2463-7KP42-0AA0	3VA2463-8KP42-0AA0

Line and generator protection, with display, with metering function, ETU860 LSI

With adjustable overload protection I_r , adjustable delayed short-circuit protection I_{sd}
and fixed instantaneous short-circuit protection I_i ,
with neutral protection against overload and short circuit from 20 %/40 % to 100 %/160 %
and adjustable ground-fault protection I_g

Connection with box terminal

25	3VA2025-6KQ46-0AA0	3VA2025-7KQ46-0AA0	3VA2025-8KQ46-0AA0
40	3VA2040-6KQ46-0AA0	3VA2040-7KQ46-0AA0	3VA2040-8KQ46-0AA0
63	3VA2063-6KQ46-0AA0	3VA2063-7KQ46-0AA0	3VA2063-8KQ46-0AA0
100	3VA2010-6KQ46-0AA0	3VA2010-7KQ46-0AA0	3VA2010-8KQ46-0AA0
25	3VA2125-6KQ46-0AA0	3VA2125-7KQ46-0AA0	3VA2125-8KQ46-0AA0
40	3VA2140-6KQ46-0AA0	3VA2140-7KQ46-0AA0	3VA2140-8KQ46-0AA0
63	3VA2163-6KQ46-0AA0	3VA2163-7KQ46-0AA0	3VA2163-8KQ46-0AA0
100	3VA2110-6KQ46-0AA0	3VA2110-7KQ46-0AA0	3VA2110-8KQ46-0AA0
160	3VA2116-6KQ46-0AA0	3VA2116-7KQ46-0AA0	3VA2116-8KQ46-0AA0

Connection with lug terminal

25	3VA2025-6KQ42-0AA0	3VA2025-7KQ42-0AA0	3VA2025-8KQ42-0AA0
40	3VA2040-6KQ42-0AA0	3VA2040-7KQ42-0AA0	3VA2040-8KQ42-0AA0
63	3VA2063-6KQ42-0AA0	3VA2063-7KQ42-0AA0	3VA2063-8KQ42-0AA0
100	3VA2010-6KQ42-0AA0	3VA2010-7KQ42-0AA0	3VA2010-8KQ42-0AA0
25	3VA2125-6KQ42-0AA0	3VA2125-7KQ42-0AA0	3VA2125-8KQ42-0AA0
40	3VA2140-6KQ42-0AA0	3VA2140-7KQ42-0AA0	3VA2140-8KQ42-0AA0
63	3VA2163-6KQ42-0AA0	3VA2163-7KQ42-0AA0	3VA2163-8KQ42-0AA0
100	3VA2110-6KQ42-0AA0	3VA2110-7KQ42-0AA0	3VA2110-8KQ42-0AA0
160	3VA2116-6KQ42-0AA0	3VA2116-7KQ42-0AA0	3VA2116-8KQ42-0AA0
160	3VA2216-6KQ42-0AA0	3VA2216-7KQ42-0AA0	3VA2216-8KQ42-0AA0
250	3VA2225-6KQ42-0AA0	3VA2225-7KQ42-0AA0	3VA2225-8KQ42-0AA0
250	3VA2325-6KQ42-0AA0	3VA2325-7KQ42-0AA0	3VA2325-8KQ42-0AA0
400	3VA2340-6KQ42-0AA0	3VA2340-7KQ42-0AA0	3VA2340-8KQ42-0AA0
400	3VA2440-6KQ42-0AA0	3VA2440-7KQ42-0AA0	3VA2440-8KQ42-0AA0
500	3VA2450-6KQ42-0AA0	3VA2450-7KQ42-0AA0	--
630	3VA2463-6KQ42-0AA0	3VA2463-7KQ42-0AA0	3VA2463-8KQ42-0AA0

Molded Case Circuit Breakers

3VA2 Molded Case Circuit Breakers up to 630 A, IEC **NEW**

Motor and starter protection

PU (UNIT, SET, M) = 1

PS*/P. unit = 1 unit

PG = 1CB

2



Connection technology	Type	Rated current I_n	Current setting of the inverse-time delayed overload protection "L" I_r	S function (short-time delayed short-circuit protection "S") I_{sd}	Operating current of the instantaneous short-circuit protection "I" I_i	DT
		A	A	A	A	

I_{cu} up to 55 kA at 415 V, medium breaking capacity M M

See "Overview", p. 2/6 and 2/7

Article No. www.siemens.com/product?Article No. Basic price per PU

3-pole, fixed-mounted, 3VA20 to 3VA24, up to 630 A Electronic trip unit

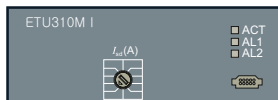

1201_18428

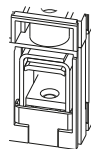

Starter protection, ETU310M I

With adjustable short-circuit protection I_i

Connection with box terminal

3VA21	25	40	63	100	--	--	--	75 ... 375	120 ... 600	189 ... 945	300 ... 1500

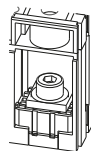
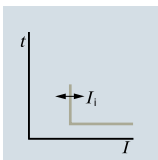

Connection with lug terminal

3VA21	25	40	63	100	--	--	--	75 ... 375	120 ... 600	189 ... 945	300 ... 1500
3VA22	160	200	--	--	--	--	--	480 ... 2400	600 ... 3000	--	--
3VA23	250	--	--	--	--	--	--	750 ... 3750	--	--	--
3VA24	400	500	--	--	--	--	--	1200 ... 6000	1500 ... 7500	--	--



1201_18429

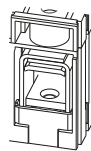

Motor protection, ETU350M LSI

With adjustable overload protection I_r (delay adjustable via trip class T_C (10A, 10/10E, 20/20E), adjustable delayed short-circuit protection I_{sd} and fixed instantaneous short-circuit protection I_i

$I_r \times \dots$

Connection with box terminal

3VA21	25	40	63	100	10 ... 25	16 ... 40	25 ... 63	40 ... 100	3 ... 15	3 ... 15	3 ... 15	3 ... 15	375	600	945	1500

[3VA2125-5MN36-0AA0](#)
[3VA2140-5MN36-0AA0](#)
[3VA2163-5MN36-0AA0](#)
[3VA2110-5MN36-0AA0](#)

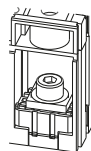
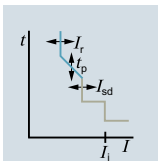

Connection with screw terminal

3VA21	25	40	63	100	10 ... 25	16 ... 40	25 ... 63	40 ... 100	3 ... 15	3 ... 15	3 ... 15	3 ... 15	375	600	945	1500
3VA22	160	200	--	--	63 ... 160	80 ... 200	--	--	3 ... 15	3 ... 15	3 ... 15	3 ... 15	2400	3000	--	--
3VA23	250	--	--	--	100 ... 250	--	--	--	3 ... 15	--	--	--	3750	--	--	--
3VA24	400	500	--	--	160 ... 400	200 ... 500	--	--	3 ... 15	3 ... 15	3 ... 15	3 ... 15	6000	7500	--	--

[3VA2125-5MN32-0AA0](#)
[3VA2140-5MN32-0AA0](#)
[3VA2163-5MN32-0AA0](#)
[3VA2110-5MN32-0AA0](#)
[3VA2216-5MN32-0AA0](#)
[3VA2220-5MN32-0AA0](#)
[3VA2325-5MN32-0AA0](#)
[3VA2440-5MN32-0AA0](#)
[3VA2450-5MN32-0AA0](#)



1201_18484

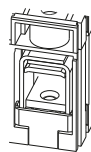

Motor protection, with display, with metering function, ETU860M LSiG

With adjustable overload protection I_r (delay adjustable either via trip class T_C (10A, 10/10E, 20/20E, 30/30E) or directly via T_P in the range of 3 ... 30 s at 7.2 x I (depending on size)), adjustable delayed short-circuit protection I_{sd} , and adjustable instantaneous short-circuit protection I_i , and fixed ground-fault protection I_g

Connection with box terminal

3VA21	25	40	63	100	10 ... 25	16 ... 40	25 ... 63	40 ... 100	38 ... 375	60 ... 600	95 ... 945	150 ... 1500	75 ... 375	120 ... 600	189 ... 945	300 ... 1500

[3VA2125-5MQ36-0AA0](#)
[3VA2140-5MQ36-0AA0](#)
[3VA2163-5MQ36-0AA0](#)
[3VA2110-5MQ36-0AA0](#)

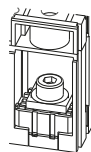
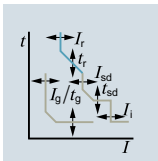

Connection with screw terminal

3VA21	25	40	63	100	10 ... 25	16 ... 40	25 ... 63	40 ... 100	30 ... 375	48 ... 600	76 ... 945	120 ... 1500	75 ... 375	120 ... 600	189 ... 945	300 ... 1500
3VA22	160	200	--	--	63 ... 160	80 ... 200	--	--	192 ... 2400	240 ... 3000	--	--	480 ... 2400	600 ... 3000	--	--
3VA23	250	--	--	--	100 ... 250	--	--	--	300 ... 3750	750 ... 3750	--	--	750 ... 3750	--	--	--
3VA24	400	500	--	--	160 ... 400	200 ... 500	--	--	480 ... 6000	600 ... 7500	--	--	1200 ... 6000	1500 ... 7500	--	--

[3VA2125-5MQ32-0AA0](#)
[3VA2140-5MQ32-0AA0](#)
[3VA2163-5MQ32-0AA0](#)
[3VA2110-5MQ32-0AA0](#)
[3VA2216-5MQ32-0AA0](#)
[3VA2220-5MQ32-0AA0](#)
[3VA2325-5MQ32-0AA0](#)
[3VA2440-5MQ32-0AA0](#)
[3VA2450-5MQ32-0AA0](#)

PU (UNIT, SET, M) = 1

PS*/P. unit = 1 unit

PG = 1CB

Rated current I_n	DT	I_{cu} up to 85 kA at 415 V, high breaking capacity H See "Overview", p. 2/6 and 2/7	DT	I_{cu} up to 110 kA at 415 V, very high breaking capacity C See "Overview", p. 2/6 and 2/7
A		Article No. www.siemens.com/product?Article No. Basic price per PU		Article No. www.siemens.com/product?Article No. Basic price per PU

Starter protection, ETU310M I

With adjustable short-circuit protection I_i

	Connection with box terminal	Connection with lug terminal
25	---	3VA2125-7MS36-0AA0
40	---	3VA2140-7MS36-0AA0
63	---	3VA2163-7MS36-0AA0
100	---	3VA2110-7MS36-0AA0
25	---	3VA2125-7MS32-0AA0
40	---	3VA2140-7MS32-0AA0
63	---	3VA2163-7MS32-0AA0
100	---	3VA2110-7MS32-0AA0
160	---	3VA2216-7MS32-0AA0
200	---	3VA22 20-7MS32-0AA0
250	---	3VA2325-7MS32-0AA0
400	---	3VA2440-7MS32-0AA0
500	---	3VA2450-7MS32-0AA0

Motor protection, ETU350M LSI

With adjustable overload protection I_p (delay adjustable via trip class T_C (10A, 10/10E, 20/20E), adjustable delayed short-circuit protection I_{sd} and fixed instantaneous short-circuit protection I_i

	Connection with box terminal	Connection with lug terminal
25	---	3VA2125-7MN36-0AA0
40	---	3VA2140-7MN36-0AA0
63	---	3VA2163-7MN36-0AA0
100	---	3VA2110-7MN36-0AA0
25	---	3VA2125-7MN32-0AA0
40	---	3VA2140-7MN32-0AA0
63	---	3VA2163-7MN32-0AA0
100	---	3VA2110-7MN32-0AA0
160	---	3VA2216-7MN32-0AA0
200	---	3VA2220-7MN32-0AA0
250	---	3VA2325-7MN32-0AA0
400	---	3VA2440-7MN32-0AA0
500	---	3VA2450-7MN32-0AA0

Motor protection, with display, with metering function, ETU860M LSI G

With adjustable overload protection I_p (delay adjustable either via trip class T_C (10A, 10/10E, 20/20E, 30/30E) or directly via T_p in the range of 3 ... 30 s at $7.2 \times I$ (depending on size)), adjustable delayed short-circuit protection I_{sd} , and adjustable instantaneous short-circuit protection I_i , and fixed ground-fault protection I_g

	Connection with box terminal	Connection with lug terminal
25	---	3VA2125-7MQ36-0AA0
40	---	3VA2140-7MQ36-0AA0
63	---	3VA2163-7MQ36-0AA0
100	---	3VA2110-7MQ36-0AA0
25	---	3VA2125-7MQ32-0AA0
40	---	3VA2140-7MQ32-0AA0
63	---	3VA2163-7MQ32-0AA0
100	---	3VA2110-7MQ32-0AA0
160	---	3VA2216-7MQ32-0AA0
200	---	3VA2220-7MQ32-0AA0
250	---	3VA2325-7MQ32-0AA0
400	---	3VA2440-7MQ32-0AA0
500	---	3VA2450-7MQ32-0AA0

Molded Case Circuit Breakers

3VA Molded Case Circuit Breakers – Accessories, IEC **NEW**

Internal accessories

Overview

Color coding of accessories

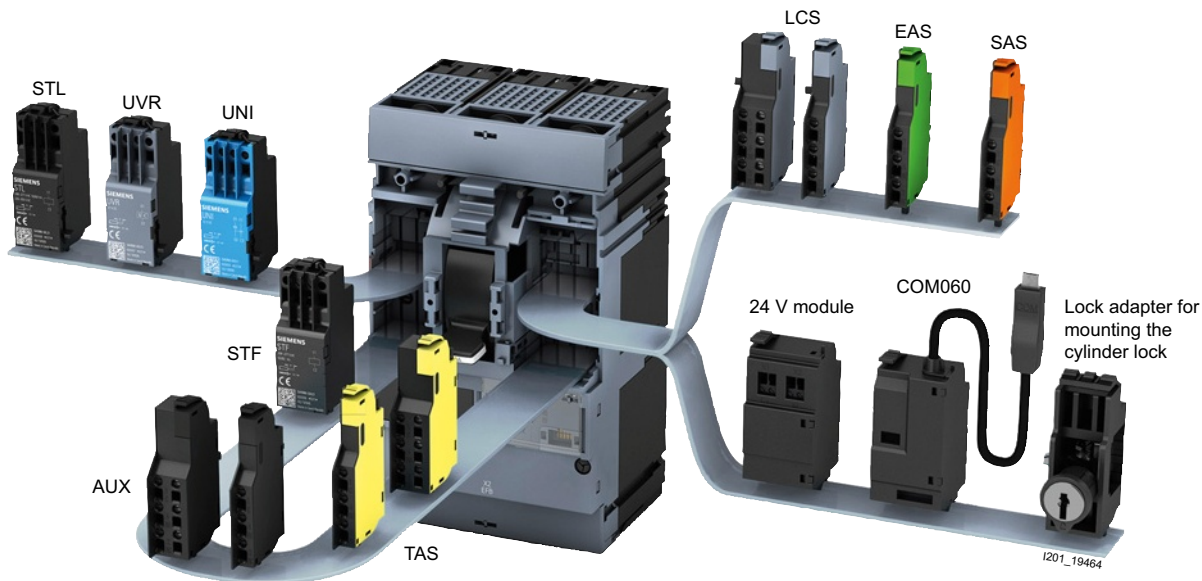

A color coding system has been used to clearly identify the specific functions of individual accessories:

Color	Auxiliary switches and alarm switches	Auxiliary release
Black	Auxiliary switch AUX	<ul style="list-style-type: none"> • Shunt trip left STL • Shunt trip flexible STF
Gray	Leading changeover switch LCS	<ul style="list-style-type: none"> • Undervoltage release UVR
Yellow	Trip alarm switches TAS	--
Orange	Short circuit alarm switch SAS	--
Green	Electrical alarm switch EAS	--
Blue	--	Universal release UNI

Auxiliary switches

All auxiliary and alarm switches for the 3VA molded case circuit breakers and switch disconnectors belong to an integrated range of accessories. The auxiliary switches can be simply snapped into place and connected up in the accessories compartment provided on the front face of the unit to the left and right of the handle.

The purpose of the auxiliary switches AUX is to signal the position of the main contacts of the molded case circuit breaker. The contacts of the auxiliary switches open and close simultaneously with the main contacts of the molded case circuit breaker.

Leading changeover switches LCS signal the opening of the main contacts with a lead time of 20 ms in advance of the circuit breaker trips and are used for load shedding, for example.

Trip alarm switches TAS signal every circuit breaker tripping operation, regardless of the cause of the trip. The trip alarm switches are actuated whenever the molded case circuit breaker switches to the TRIP position.

Electrical alarm switches EAS are actuated as soon as the main contacts of the molded case circuit breaker open in the event that the breaker is tripped by the ETU.

Special electronic-compatible variants are available for applications which require the auxiliary switch signals to be linked to automation systems.

Auxiliary release

Auxiliary releases allow remote electrical tripping of the circuit breaker. They can be used to monitor control or main circuits in order to implement a protective system against accidental restart following a power failure, for example.

Undervoltage releases trip the 3VA molded case circuit breaker in the event that the rated voltage of a monitored circuit drops below a minimum permissible limit or fails altogether.

Shunt trips can be used to trip the 3VA molded case circuit breaker remotely. The STF variant can be mounted in either the left-hand or the right-hand accessories compartment. The STL and STL (EI) types are specifically designed for mounting in the left-hand compartment and are very low-consumption devices. The STL (EI) variant can be used to implement electrical interlocks between molded case circuit breakers.

A universal release is a single, 21 mm wide component in which a shunt trip and an undervoltage release are combined. These are subject to the same tripping conditions as the individual devices.

Short circuit alarm switch SAS

Short circuit alarm switches signal tripping operations only if they have been initiated by a short circuit. Tripping due to a short circuit is also indicated on the molded case circuit breaker.

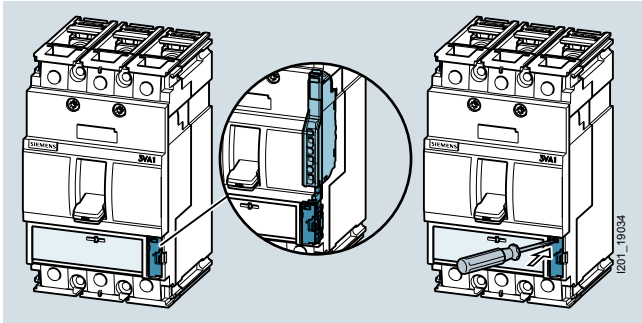

The tripping operation must be reset by deliberate acknowledgement of the fault before the molded case circuit breaker can be switched to ON again.

Note

Short circuit alarm switches are only compatible with 3VA1 molded case circuit breakers. On breakers equipped with electronic trip units, the short circuit alarm function is performed by the electronic trip unit (ETU) and the EFB external function box.

3VA with internal accessories pre-assembled at the factory

The basic circuit breakers with -0AA0 at the end of the article number are supplied without installed internal accessories.

Due to the high number of different internal accessory components available and the associated flexibility of use, it is not possible to represent all options with an article number for circuit breakers and installed internal accessories.

However, it is possible to order a basic circuit breaker with pre-defined combinations of internal accessories that are installed at the factory. This concerns a selection of different auxiliary releases and auxiliary/alarm switch combinations especially for each basic circuit breaker type.

Benefits

- The internal accessories are extremely easy to install. No tools are required because they are simply snapped into place in the accessories compartments to the left and right of the handle.
- The accessories are connected by screw terminals for auxiliary conductors with a cross-section of up to 2.5 mm². The terminals are mounted on the front of the unit for easy access.
- All auxiliary and alarm switches are designed as changeover contacts and therefore provide a high degree of flexibility for planning and installation purposes.
- Slimline auxiliary and alarm switches HQ and double-width auxiliary and alarm switches HP are suitable for use in applications involving diverse types of signaling contact and with high continuous currents.
- With two conductors per contact point for the auxiliary and alarm switches HP, looping through is extremely easy.
- Symbols engraved in the lid of the accessories compartment indicate the possible mounting positions of the internal accessories.

In the case of factory installation, an installation surcharge is levied for the installed internal accessories.

The normal delivery time for equipped 3VA breakers is 10 working days. The best possible delivery times are only achieved when the individual components are ordered.

Basic circuit breakers with pre-installed internal accessories can only be ordered by registered customers using the 3VA Configurator:

www.siemens.com/lowvoltage/configurator-3VA

Molded Case Circuit Breakers

3VA Molded Case Circuit Breakers – Accessories, IEC **NEW**

Internal accessories

Design

2

Internal accessories		3VA1 160 A 2-pole	3VA1 100 A 3- and 4-pole	3VA1 160 A 3- and 4-pole	3VA1 250 A 3- and 4-pole
Optional equipment		Slot No.:		Slot No.:	
		23 22 21	23 22 21 11 12 13	23 22 21 11 12 13	24 23 22 21 11 12 13 14
Auxiliary switch	AUX_HQ	x x x	x x x x x x	x x x x x x	x x x x x x x x
	AUX_HQ_el	x x x	x x x x x x	x x x x x x	x x x x x x x x
	AUX_HP	x		x	x x x
Leading changeover switch	LCS_HQ			x	x
	LCS_HQ_el			x	x
	LCS_HP			x	x
Alarm switch	TAS_HQ	x x	x x x x	x x x x	x x x x
	TAS_HQ_el	x x	x x x x	x x x x	x x x x
	TAS_HP	x		x	x
Short circuit alarm switch	SAS_HQ				x
	SAS_HQ_el				x
Auxiliary release	STF	x	x	x	x
	STL	x	x	x	x
	STL (EI)	x	x	x	x
	RCR ¹⁾		x	x	x
	UVR	x	x	x	x
	UNI	x	x	x	x
Other	Cylinder lock (type Ronis)		x	x	x

¹⁾ Included in the scope of supply for side mounted residual current devices

Internal accessories		3VA2 100/160/250 A 3-pole	3VA2 100/160/250 A 4-pole
Optional equipment		24 23 22 21 11 12 13 14	34 33 32 31 24 23 22 21 11 12 13 14
		250 A	
		Slot No.:	
Auxiliary switch	Type		
Auxiliary switch	AUX_HQ	x x x x x x x x	x x x x x x x x
	AUX_HQ_el	x x x x x x x x	x x x x x x x x
	AUX_HP	x x x x x x	x x x x x x
Leading changeover switch	LCS_HQ		
	LCS_HQ_el		
	LCS_HP		
Alarm switch	Type		
Trip alarm switch	TAS_HQ	x x x x	x x x x
	TAS_HQ_el	x x x x	x x x x
	TAS_HP	x x x x	x x x x
Electrical alarm switch	EAS_HQ		
	EAS_HQ_el		
Auxiliary release	Type		
Shunt trip flexible	STF	x x x x	x x x x
Shunt trip left	STL	x x x x	x x x x
	STL (EI)	x x x x	x x x x
Undervoltage release	UVR	x x x x	x x x x
Universal release	UNI	x x x x	x x x x
ETU/communication	Type		
Breaker data server communication module	COM060		
24 V module			
Other			
Cylinder lock (type Ronis)			

I201_18812

Molded Case Circuit Breakers

3VA Molded Case Circuit Breakers – Accessories, IEC **NEW**

Internal accessories

2

Internal accessories		3VA2 400/630 A 3-pole															3VA2 400/630 A 4-pole														
Optional equipment		630 A															630 A														
		Slot No.:															Slot No.:														
		25	24	23	22	21	11	12	13	14	15	35	34	33	32	31	25	24	23	22	21	11	12	13	14	15					
Auxiliary switch	Type																														
Auxiliary switch	AUX_HQ	x	x	x	x	x	x	x	x	x	x	x	x	x	x	x	x	x	x	x	x	x	x	x	x	x					
	AUX_HQ_el	x	x	x	x	x	x	x	x	x	x	x	x	x	x	x	x	x	x	x	x	x	x	x	x	x					
	AUX_HP			x	x				x	x				x	x				x	x				x	x						
Leading changeover switch	LCS_HQ								x																	x					
	LCS_HQ_el								x																	x					
	LCS_HP									x																x					
Alarm switch	Type																														
Trip alarm switch	TAS_HQ			x	x			x	x										x	x											
	TAS_HQ_el			x	x			x	x										x	x											
	TAS_HP			x				x											x												
Electrical alarm switch	EAS_HQ																									x					
	EAS_HQ_el																									x					
Auxiliary release	Type																														
Shunt trip flexible	STF			x					x										x							x					
Shunt trip left	STL			x															x												
	STL (EI)			x															x												
Undervoltage release	UVR			x															x												
Universal release	UNI			x															x												
ETU/communication	Type																														
Breaker data server communication module	COM060																									x					
24 V module																										x					
Other																															
Cylinder lock (type Ronis)																										x					

I201_18812

Selection and ordering data

Version	DT	Article No. www.siemens.com/ product?Article No.	Price per PU	PU (UNIT, SET, M)	PS*/ P. unit	PG
Auxiliary Switches and Alarm Switches						
Auxiliary switch AUX						
 3VA9988-0AA11 3VA9988-0AA12	Type/switching capacity/size	Electronic-compatible				
	HP/high switching capacity/2 slots	--	3VA9988-0AA11 3VA9988-0AA12 3VA9988-0AA13	1	1 unit	1CB
	HQ/compact size/1 slot	--		1	1 unit	1CB
	HQ_el/compact size/1 slot	✓		1	1 unit	1CB
Leading changeover switch LCS						
 3VA9988-0AA21 3VA9988-0AA22	Type/switching capacity/size	Electronic-compatible				
	HP/high switching capacity/2 slots	--	3VA9988-0AA21 3VA9988-0AA22 3VA9988-0AA23	1	1 unit	1CB
	HQ/compact size/1 slot	--		1	1 unit	1CB
	HQ_el/compact size/1 slot	✓		1	1 unit	1CB
Trip alarm switch TAS						
 3VA9988-0AB11 3VA9988-0AB12	Type/switching capacity/size	Electronic-compatible				
	HP/high switching capacity/2 slots	--	3VA9988-0AB11 3VA9988-0AB12 3VA9988-0AB13	1	1 unit	1CB
	HQ/compact size/1 slot	--		1	1 unit	1CB
	HQ_el/compact size/1 slot	✓		1	1 unit	1CB
Short-circuit alarm switches SAS (3VA1 only)						
 3VA9988-0AB32	For molded case circuit breakers, frame size	Electronic-compatible				
	For 3VA1 100 A/160 A		3VA9988-0AB32 3VA9988-0AB33	1	1 unit	1CB
	• HQ/compact size/1 slot	--		1	1 unit	1CB
	• HQ_el/compact size/1 slot	✓				
	For 3VA1 250 A		3VA9988-0AB34 3VA9988-0AB35	1	1 unit	1CB
	• HQ/compact size/1 slot	--		1	1 unit	1CB
• HQ_el/compact size/1 slot	✓					
Electrical alarm switches EAS (3VA2 only)						
 3VA9988-0AB22	Type/switching capacity/size	Electronic-compatible				
	HQ/compact size/1 slot	--	3VA9988-0AB22 3VA9988-0AB23	1	1 unit	1CB
	HQ_el/compact size/1 slot	✓		1	1 unit	1CB
Undervoltage releases						
Undervoltage release UVR						
 3VA9908-0BB15	50/60 Hz V AC	V DC				
	--	12	3VA9908-0BB10 3VA9908-0BB11 3VA9908-0BB12 3VA9908-0BB13	1	1 unit	1CB
	--	24		1	1 unit	1CB
	--	48		1	1 unit	1CB
	--	60		1	1 unit	1CB
	--	125 ... 127		1	1 unit	1CB
	--	220 ... 230		1	1 unit	1CB
	--	250	1	1 unit	1CB	
	24	--	3VA9908-0BB20 3VA9908-0BB21 3VA9908-0BB22 3VA9908-0BB23	1	1 unit	1CB
	48	--		1	1 unit	1CB
	60	--		1	1 unit	1CB
	110	--		1	1 unit	1CB
	120 ... 127	--		1	1 unit	1CB
	208 ... 230	--		1	1 unit	1CB
	380 ... 400	--		1	1 unit	1CB
	440 ... 480	--	1	1 unit	1CB	
		3VA9908-0BB24 3VA9908-0BB25 3VA9908-0BB26 3VA9908-0BB27				

Molded Case Circuit Breakers

3VA Molded Case Circuit Breakers – Accessories, IEC **NEW**

Internal accessories

2

Version	DT	Article No. www.siemens.com/ product?Article No.	Price per PU	PU (UNIT, SET, M)	PS*/ P. unit	PG
Shunt trip left						
Shunt trip left STL						
50/60 Hz V AC	V DC					
--	12	3VA9988-0BL10		1	1 unit	1CB
24	24 ... 30	3VA9988-0BL30		1	1 unit	1CB
110 ... 127	110 ... 127	3VA9988-0BL32		1	1 unit	1CB
208 ... 277	220 ... 250	3VA9988-0BL33		1	1 unit	1CB
--	12	3VA9988-0BL10		1	1 unit	1CB
380 ... 600	--	3VA9988-0BL20		1	1 unit	1CB
Shunt trip left STL (EI)						
50/60 Hz V AC	V DC					
--	24	3VA9988-0BM10		1	1 unit	1CB
Shunt trip flexible STF						
Shunt trip flexible						
50/60 Hz V AC	V DC					
24	--	3VA9988-0BA20		1	1 unit	1CB
48 ... 60	--	3VA9988-0BA21		1	1 unit	1CB
110 ... 127	--	3VA9988-0BA22		1	1 unit	1CB
208 ... 277	--	3VA9988-0BA23		1	1 unit	1CB
380 ... 500	--	3VA9988-0BA24		1	1 unit	1CB
600	--	3VA9988-0BA25		1	1 unit	1CB
Universal release UNI						
Universal release						
50/60 Hz V AC	V DC					
--	12	3VA9908-0BD11		1	1 unit	1CB
--	24	3VA9908-0BD12		1	1 unit	1CB
--	48	3VA9908-0BD13		1	1 unit	1CB
Time-delay device for undervoltage releases						
Time-delay device						
V AC	V DC	Delay time				
110	110	Fixed	3VA9988-0BF21	1	1 unit	1CB
230	230	Fixed	3VA9988-0BF22	1	1 unit	1CB
--	24	Fixed	3VA9988-0BF23	1	1 unit	1CB



3VA9988-0BL33



3VA9988-0BA23



3VA9908-0BD13



3VA9988-0BF22

Overview

Manual operators are provided to facilitate manual operation of the 3VA molded case circuit breakers, either directly at the circuit breaker or through the door or side wall of the cubicle.

Front mounted rotary operators

The front mounted rotary operator is mounted directly on the molded case circuit breaker and is available with or without a door interlocking system. It meets the requirements for degree of protection IP30. The door interlock locks the cubicle door when the molded case circuit breaker is closed, but can be deliberately overridden if necessary.

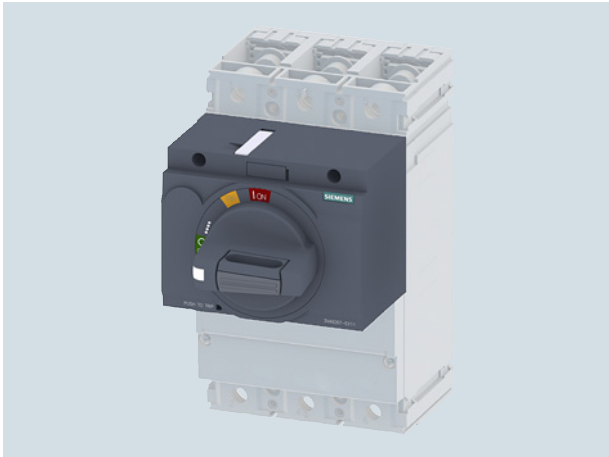

Door mounted rotary operator

The door mounted rotary operator enables operation of the molded case circuit breaker from the cubicle door. The door element meets the requirements for degree of protection IP65 and features a door interlocking system and tolerance compensation. A variable depth adapter can be deployed to allow use of the door mounted rotary operator in conjunction with draw-out units. A supplementary handle can be attached directly to the shaft shoulder to allow convenient operation of the molded case circuit breaker when the cubicle door is open (i.e. when the control element is decoupled).

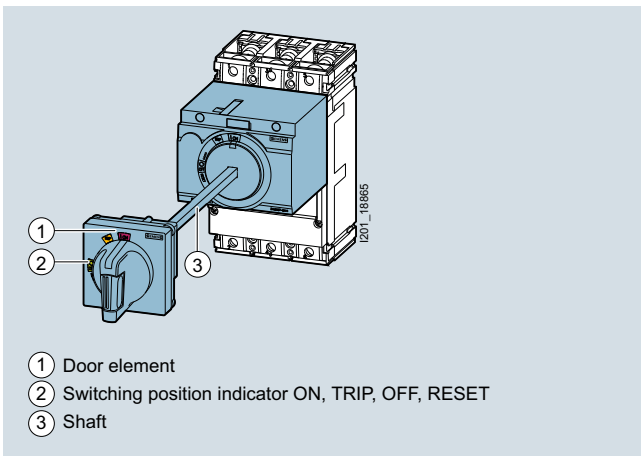

Side wall mounted rotary operators

The side wall mounted rotary operator is designed for installation in the cubicle side wall. It is available optionally with short shaft and mounting plate for mounting directly adjacent to the cubicle wall. The wall element meets the requirements for degree of protection IP65.

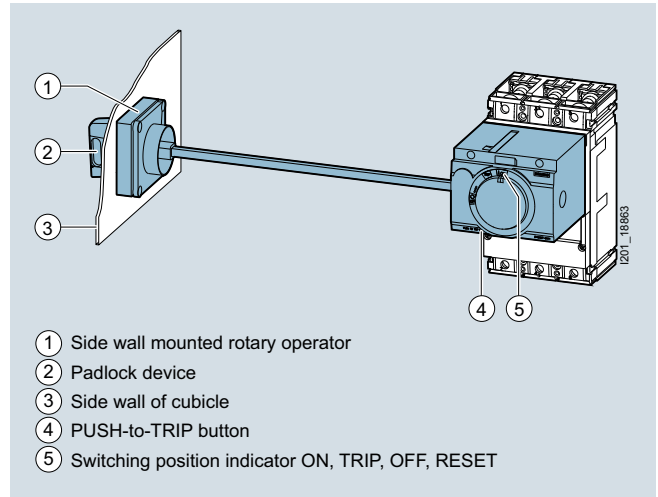

All manual operators as well as the supplementary handle for the door mounted rotary operator are also available in a version for use in EMERGENCY OFF applications. These are colored a conspicuous yellow/red for easier identification.

Interlocking methods

All manual operators are designed to allow locking of the operator at the handle and at the rotary operator with up to three padlocks in each case. It is also possible to fit a cylinder lock which can be used either to lock or to interlock molded case circuit breakers depending on the application.

If the cylinder lock is applied as a lock, it can be used to prevent the molded case circuit breaker from closing. The key can be removed at any time. If the lock is used to create an interlock, the key can be removed only when it is in the OFF position, allowing the creation of an interlock by the use of a single key for several breakers.

Active illumination

The manual operators are also available in illuminated variants in which the handle is illuminated red, yellow or green via LEDs (24 V DC) depending on the position of the breaker. This means that the switching position of the molded case circuit breaker can be immediately identified, even when light conditions are poor. This option can also be retrofitted.

Benefits



- Convenient circuit breaker operation inside and outside the cubicle
- Locking and interlocking for all manual operators prevents unauthorized breaker operation
- Conspicuously colored variant for EMERGENCY OFF circuits
- Illumination for clear indication of switching position even when light conditions are poor
- All manual operators meet the standards for isolating characteristics defined by IEC / EN 60947-1

Molded Case Circuit Breakers

3VA Molded Case Circuit Breakers – Accessories, IEC **NEW**

Manual operators

Selection and ordering data

Version	For molded case circuit breakers/ frame size				DT	Article No. www.siemens.com/ product?Article No.	Price per PU	PU (UNIT, SET, M)	PS*/ P. unit	PG	
	3VA1 100 A, 160 A	3VA1 250 A	3VA2 100 A, 160 A, 250 A	3VA2 400 A, 630 A							
Front mounted rotary operators											
 3VA9267-0EK11	Front mounted rotary operators										
	<ul style="list-style-type: none"> Rotary operating mechanisms Handle For IEC Degree of protection IP30 										
	Type	Color									
	• Standard, without illumination kit	Gray	✓	--	--	--	3VA9157-0EK11		1	1 unit	1CB
			--	✓	--	--	3VA9257-0EK11		1	1 unit	1CB
			--	--	✓	--	3VA9267-0EK11		1	1 unit	1CB
			--	--	--	✓	3VA9467-0EK11		1	1 unit	1CB
	• Standard, with illumination kit	Gray	✓	--	--	--	3VA9157-0EK13		1	1 unit	1CB
			--	✓	--	--	3VA9257-0EK13		1	1 unit	1CB
			--	--	✓	--	3VA9267-0EK13		1	1 unit	1CB
--			--	--	✓	3VA9467-0EK13		1	1 unit	1CB	
• EMERGENCY OFF, without illumination kit	Yellow-red	✓	--	--	--	3VA9157-0EK15		1	1 unit	1CB	
		--	✓	--	--	3VA9257-0EK15		1	1 unit	1CB	
		--	--	✓	--	3VA9267-0EK15		1	1 unit	1CB	
		--	--	--	✓	3VA9467-0EK15		1	1 unit	1CB	
• EMERGENCY OFF, with illumination kit	Yellow-red	✓	--	--	--	3VA9157-0EK17		1	1 unit	1CB	
		--	✓	--	--	3VA9257-0EK17		1	1 unit	1CB	
		--	--	✓	--	3VA9267-0EK17		1	1 unit	1CB	
		--	--	--	✓	3VA9467-0EK17		1	1 unit	1CB	
• Standard, with door interlock	Gray	✓	--	--	--	3VA9157-0EK21		1	1 unit	1CB	
		--	✓	--	--	3VA9257-0EK21		1	1 unit	1CB	
		--	--	✓	--	3VA9267-0EK21		1	1 unit	1CB	
		--	--	--	✓	3VA9467-0EK21		1	1 unit	1CB	
• Standard, with door interlock, with illumination kit	Gray	✓	--	--	--	3VA9157-0EK23		1	1 unit	1CB	
		--	✓	--	--	3VA9257-0EK23		1	1 unit	1CB	
		--	--	✓	--	3VA9267-0EK23		1	1 unit	1CB	
		--	--	--	✓	3VA9467-0EK23		1	1 unit	1CB	
• EMERGENCY OFF, with door interlock	Yellow-red	✓	--	--	--	3VA9157-0EK25		1	1 unit	1CB	
		--	✓	--	--	3VA9257-0EK25		1	1 unit	1CB	
		--	--	✓	--	3VA9267-0EK25		1	1 unit	1CB	
		--	--	--	✓	3VA9467-0EK25		1	1 unit	1CB	
• EMERGENCY OFF, with door interlock, with illumination kit	Yellow-red	✓	--	--	--	3VA9157-0EK27		1	1 unit	1CB	
		--	✓	--	--	3VA9257-0EK27		1	1 unit	1CB	
		--	--	✓	--	3VA9267-0EK27		1	1 unit	1CB	
		--	--	--	✓	3VA9467-0EK27		1	1 unit	1CB	
 3VA9267-0GK00	Gray	✓	--	--	--	3VA9157-0GK00		1	1 unit	1CB	
		--	✓	--	--	3VA9257-0GK00		1	1 unit	1CB	
		--	--	✓	--	3VA9267-0GK00		1	1 unit	1CB	
		--	--	--	✓	3VA9467-0GK00		1	1 unit	1CB	

Version	For molded case circuit breakers/ frame size				DT	Article No. www.siemens.com/ product?Article No.	Price per PU	PU (UNIT, SET, M)	PS*/ P. unit	PG
	3VA1 100 A, 160 A	3VA1 250 A	3VA2 100 A, 160 A, 250 A	3VA2 400 A, 630 A						

Door mounted rotary operator



- Door mounted rotary operator**
- Rotary operating mechanisms
 - Shaft 300 mm
 - Mounting tolerance compensation
 - Handle with masking plate 75 × 75 mm
 - Degree of protection IP65

Type	Color	3VA1 100 A, 160 A	3VA1 250 A	3VA2 100 A, 160 A, 250 A	3VA2 400 A, 630 A	Article No.	Price per PU	PU (UNIT, SET, M)	PS*/ P. unit	PG
• Standard	Gray	✓	--	--	--	3VA9157-0FK21		1	1 unit	1CB
		--	✓	--	--	3VA9257-0FK21		1	1 unit	1CB
		--	--	✓	--	3VA9267-0FK21		1	1 unit	1CB
		--	--	--	✓	3VA9467-0FK21		1	1 unit	1CB
• Standard, with illumination kit	Gray	✓	--	--	--	3VA9157-0FK23		1	1 unit	1CB
		--	✓	--	--	3VA9257-0FK23		1	1 unit	1CB
		--	--	✓	--	3VA9267-0FK23		1	1 unit	1CB
		--	--	--	✓	3VA9467-0FK23		1	1 unit	1CB
• EMERGENCY OFF	Yellow- red	✓	--	--	--	3VA9157-0FK25		1	1 unit	1CB
		--	✓	--	--	3VA9257-0FK25		1	1 unit	1CB
		--	--	✓	--	3VA9267-0FK25		1	1 unit	1CB
		--	--	--	✓	3VA9467-0FK25		1	1 unit	1CB
• EMERGENCY OFF, with illumination kit	Yellow- red	✓	--	--	--	3VA9157-0FK27		1	1 unit	1CB
		--	✓	--	--	3VA9257-0FK27		1	1 unit	1CB
		--	--	✓	--	3VA9267-0FK27		1	1 unit	1CB
		--	--	--	✓	3VA9467-0FK27		1	1 unit	1CB

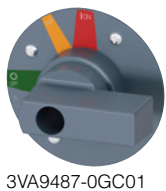

Supplementary handle for door mounted rotary operator

Type	Color	3VA1 100 A, 160 A	3VA1 250 A	3VA2 100 A, 160 A, 250 A	3VA2 400 A, 630 A	Article No.	Price per PU	PU (UNIT, SET, M)	PS*/ P. unit	PG
• Standard	Gray	✓	✓	--	--	3VA9287-0GC01		1	1 unit	1CB
		--	--	✓	--	3VA9487-0GC01		1	1 unit	1CB
		--	--	--	✓	3VA9487-0GC11		1	1 unit	1CB
• EMERGENCY OFF	Yellow- red	✓	✓	--	--	3VA9287-0GC05		1	1 unit	1CB
		--	--	✓	--	3VA9487-0GC05		1	1 unit	1CB
		--	--	--	✓	3VA9487-0GC15		1	1 unit	1CB

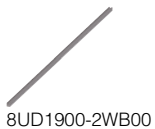

Shaft
8 mm

Versions	Article No.	Price per PU	PU (UNIT, SET, M)	PS*/ P. unit	PG
• 300 mm long	8UD1900-2WA00		1	1 unit	1CB
• 600 mm long	8UD1900-2WB00		1	1 unit	1CB



Adapter for shaft 8 mm x 8 mm
With door mounted rotary operator and
side wall mounted rotary operator

Article No.	Price per PU	PU (UNIT, SET, M)	PS*/ P. unit	PG
8UD1900-2DA00		1	1 unit	1CB



Door coupling
8 × 8 mm

Article No.	Price per PU	PU (UNIT, SET, M)	PS*/ P. unit	PG
8UD1900-2HA00		1	1 unit	1CB



Fixing bracket for shaft

3VA1 100 A, 160 A	3VA1 250 A	3VA2 100 A, 160 A, 250 A	3VA2 400 A, 630 A	Article No.	Price per PU	PU (UNIT, SET, M)	PS*/ P. unit	PG
✓	✓	--	--	3VA9287-0GA80		1	1 unit	1CB
--	--	✓	✓	3VA9487-0GA80		1	1 unit	1CB



Variable depth adapter
8 × 8 mm

Article No.	Price per PU	PU (UNIT, SET, M)	PS*/ P. unit	PG
3VA9487-0GB10		1	1 unit	1CB



Mounting tolerance compensation
8 × 8 mm

Article No.	Price per PU	PU (UNIT, SET, M)	PS*/ P. unit	PG
8UD1900-2GA00		1	1 unit	1CB

Molded Case Circuit Breakers

3VA Molded Case Circuit Breakers – Accessories, IEC **NEW**

Manual operators

2

Version	For molded case circuit breakers/ DT				Article No. www.siemens.com/ product?Article No.	Price per PU	PU (UNIT, SET, M)	PS*/ P. unit	PG
	3VA1 100 A, 160 A	3VA1 250 A	3VA2 100 A, 160 A, 250 A	3VA2 400 A, 630 A					

Side wall mounted rotary operators

Side wall mounted rotary operators

- Without mounting plate
 - Rotary operator with shaft 300 mm
 - Handle with masking plate 75 x 75 mm
 - Degree of protection IP65



3VA9267-0PK11

Type	Color	3VA1	3VA1	3VA2	3VA2	Article No.	Price	PU	PS*/	PG
• Standard	Gray	✓	--	--	--	3VA9157-0PK11		1	1 unit	1CB
		--	✓	--	--	3VA9257-0PK11		1	1 unit	1CB
		--	--	✓	--	3VA9267-0PK11		1	1 unit	1CB
		--	--	--	✓	3VA9467-0PK11		1	1 unit	1CB
• Standard, with illumination kit	Gray	✓	--	--	--	3VA9157-0PK13		1	1 unit	1CB
		--	✓	--	--	3VA9257-0PK13		1	1 unit	1CB
		--	--	✓	--	3VA9267-0PK13		1	1 unit	1CB
		--	--	--	✓	3VA9467-0PK13		1	1 unit	1CB
• EMERGENCY OFF	Yellow-red	✓	--	--	--	3VA9157-0PK15		1	1 unit	1CB
		--	✓	--	--	3VA9257-0PK15		1	1 unit	1CB
		--	--	✓	--	3VA9267-0PK15		1	1 unit	1CB
		--	--	--	✓	3VA9467-0PK15		1	1 unit	1CB
• EMERGENCY OFF, with illumination kit	Yellow-red	✓	--	--	--	3VA9157-0PK17		1	1 unit	1CB
		--	✓	--	--	3VA9257-0PK17		1	1 unit	1CB
		--	--	✓	--	3VA9267-0PK17		1	1 unit	1CB
		--	--	--	✓	3VA9467-0PK17		1	1 unit	1CB

- With mounting plate
 - Rotary operator with short shaft
 - Handle with masking plate 75 x 75 mm
 - Degree of protection IP65

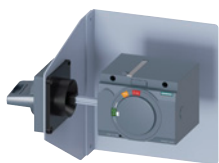

3VA9267-0PK51

Type	Color	3VA1	3VA1	3VA2	3VA2	Article No.	Price	PU	PS*/	PG
• Standard	Gray	✓	--	--	--	3VA9157-0PK51		1	1 unit	1CB
		--	✓	--	--	3VA9257-0PK51		1	1 unit	1CB
		--	--	✓	--	3VA9267-0PK51		1	1 unit	1CB
• Standard, with illumination kit	Gray	✓	--	--	--	3VA9157-0PK53		1	1 unit	1CB
		--	✓	--	--	3VA9257-0PK53		1	1 unit	1CB
		--	--	✓	--	3VA9267-0PK53		1	1 unit	1CB
• EMERGENCY OFF	Yellow-red	✓	--	--	--	3VA9157-0PK55		1	1 unit	1CB
		--	✓	--	--	3VA9257-0PK55		1	1 unit	1CB
		--	--	✓	--	3VA9267-0PK55		1	1 unit	1CB
• EMERGENCY OFF, with illumination kit	Yellow-red	✓	--	--	--	3VA9157-0PK57		1	1 unit	1CB
		--	✓	--	--	3VA9257-0PK57		1	1 unit	1CB
		--	--	✓	--	3VA9267-0PK57		1	1 unit	1CB

Extended DIN rail for N/PE terminal

- For mounting plate
- Up to 250 A



3VA9987-OGL30

						3VA9987-OGL30		1	1 unit	1CB
--	--	--	--	--	--	---------------	--	---	--------	-----

Handles

Handles

- With masking plate



8UD1731-0AB11

Type	Color	Tolerance compensation	3VA1	3VA1	3VA2	3VA2	Article No.	Price	PU	PS*/	PG
• Standard	Gray	None	✓	✓	✓	--	8UD1721-0AB11		1	1 unit	1CB
		With	✓	✓	✓	--	8UD1721-0AB21		1	1 unit	1CB
		None	--	--	--	✓	8UD1731-0AB11		1	1 unit	1CB
		With	--	--	--	✓	8UD1731-0AB21		1	1 unit	1CB
• EMERGENCY OFF	Yellow-red	None	✓	✓	✓	--	8UD1721-0AB15		1	1 unit	1CB
		With	✓	✓	✓	--	8UD1721-0AB25		1	1 unit	1CB
		None	--	--	--	✓	8UD1731-0AB15		1	1 unit	1CB
		With	--	--	--	✓	8UD1731-0AB25		1	1 unit	1CB

Version	DT	Article No. www.siemens.com/ product?Article.No.	Price per PU	PU (UNIT, SET, M)	PS*/ P. unit	PG
General accessories for manual operators						
 3VA9087-0SX10		Labeling plate for manual operators	3VA9087-0SX10	1	10 unit	1CB
 8UD1900-0KA20		Illumination kit for manual operators 24 V DC voltage	For molded case circuit breakers			
		3VA1, 100 ... 250 A	Front mounted rotary operators	8UD1900-0KA10	1	1 unit 1CB
		3VA2, 100 ... 630 A	Front mounted rotary operators	8UD1900-0KA20	1	1 unit 1CB
		3VA1, 3VA2, 100 ... 630 A	Door mounted rotary operator and side wall mounted rotary operator	8UD1900-0KA20	1	1 unit 1CB
 8UD1900-0MB01		Cylinder lock (type Kaba) • For door mounted rotary operator and side wall mounted rotary operator (in the masking plate) • Standard masking plate	Key 1	8UD1900-0MB01	1	1 unit 1CB
			Key 2	8UD1900-0NB01	1	1 unit 1CB
			Key 3	8UD1900-0PB01	1	1 unit 1CB
			Key 4	8UD1900-0QB01	1	1 unit 1CB
 8UD1900-0MB05		Cylinder lock (type Kaba) • For door mounted rotary operator and side wall mounted rotary operator (in the masking plate) • EMERGENCY OFF masking plate	Key 1	8UD1900-0MB05	1	1 unit 1CB
			Key 2	8UD1900-0NB05	1	1 unit 1CB
			Key 3	8UD1900-0PB05	1	1 unit 1CB
			Key 4	8UD1900-0QB05	1	1 unit 1CB
 3VA9488-0VF20		Rotary operator interlock¹⁾ • Contains 1 unit • For interlocking up to 3 operators (with 3 modules) • Interlocking via Bowden cable (not included in scope of delivery), see page 2/113	For molded case circuit breakers			
		3VA1, 160 A		3VA9158-0VF20		
		3VA1, 250 A		3VA9258-0VF20		
		3VA2, 250 A		3VA9268-0VF20		
		3VA2, 630 A		3VA9468-0VF20		
 3VA9980-0VL10		Cylinder lock (type Ronis) • Includes a lock with 2 keys • For locking or interlocking • For installation in all rotary operators with shaft stub • For mounting in the adapter kit for the accessories compartment	Key 1	3VA9980-0VL10	1	1 unit 1CB
			Key 2	3VA9980-0VL20	1	1 unit 1CB
			Key 3	3VA9980-0VL30	1	1 unit 1CB
			Key 4	3VA9980-0VL40	1	1 unit 1CB
Note		The cylinder lock adapter for rotary operators is also needed for locking or interlocking circuit breakers via rotary operators.				
 3VA9980-0LF20		Cylinder lock adapter for rotary operators To mount the cylinder lock in the rotary operator (also possible with door mounted rotary operator and side wall mounted rotary operator)	3VA9980-0LF20	1	1 unit	1CB

¹⁾ Start of delivery scheduled for 1st quarter 2016

Molded Case Circuit Breakers

3VA Molded Case Circuit Breakers – Accessories, IEC **NEW**

Motor operators

Overview

Lateral motorized operator MO310

The lateral motor operator MO310 is optimized for use in the area of electrical installation. It is mounted on the side of the 3VA1 molded-case circuit breaker and, thanks to the cover size of 45 mm, is suitable for side-by-side arrangement with miniature circuit breakers.

The motor operator MO310 can also be locked with several padlocks.

MO320 front motor operator

The MO320 motor operator is mounted on the front of the 3VA molded-case circuit breaker and opens and closes the molded case circuit breaker by means of control cable commands (e.g. from pushbuttons or a PLC). It can also be operated manually, however, and a handle is provided on the unit for this purpose.

The motor operator also features a clear switching position indicator which indicates ON and OFF and, via LED, whether the circuit breaker has tripped (TRIP). The motor operator therefore meets the standards for isolating characteristics defined by IEC / EN 60947-1. It is thus possible to identify the switching position of the molded case circuit breaker at any time.

Two different reset modes can be selected, i.e. in one mode, the operator resets the molded case circuit breaker automatically and in the other, it waits for confirmation by an OFF signal before it resets the breaker.

Furthermore, the motor operator can be locked in the OFF position by means of several padlocks.

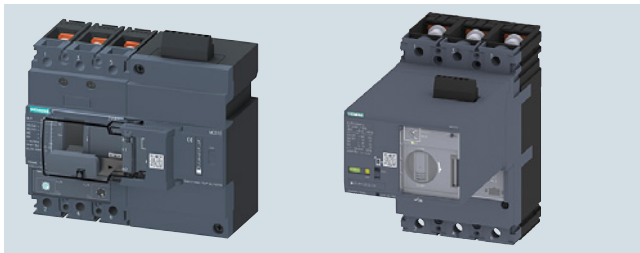

Benefits

- Remote operation of the molded case circuit breaker by means of control cable commands
- Clear switching position indication including TRIP provides a quick visual overview and prevents operating errors
- Locking capability prevents unauthorized operations
- Meets the standards for isolating characteristics defined by IEC / EN 60947-1

Design

- The MO320 motor operator is simply snapped into position on a mounting frame which is installed instead of the accessories lid of the molded case circuit breaker.

Technical specifications



MO310 motor operator	3VA1
	160 A
Degree of protection	IP20, with escutcheon IP30
Rated control supply voltage (operating range of control supply voltage)	42 V ... 60 V AC/ 24 V ... 60 V DC (0.85 ... 1.26)
	110 V ... 230 V AC/ 110 V ... 250 V DC (0.85 ... 1.1)
Rating	250 W, max. 500 W (60 ms)
Make time, typically	< 300 ms
Break time, typically	< 300 ms

MO320 motor operator	3VA1		3VA2	
	160 A	250 A	250 A	630 A
Degree of protection	IP20, with escutcheon IP30			
Rated control supply voltage (operating range of control supply voltage)	24 V ... 60 V DC (0.85 ... 1.26)			
	110 V ... 230 V AC/ 110 V ... 250 V DC (0.85 ... 1.1)			
Rating	250 W, max. 500 W (60 ms)			
Make time, typically	< 800 ms	< 800 ms	< 1000 ms	< 1700 ms
Break time, typically	< 800 ms	< 800 ms	< 1000 ms	< 1400 ms

Selection and ordering data

Version	For molded case circuit breakers/ DT frame size				Article No. www.siemens.com/product?Article No.	Price per PU	PU (UNIT, SET, M)	PS*/ P. unit	PG
	3VA1 160 A	3VA1 250 A	3VA2 100 A, 160 A, 250 A	3VA2 400 A, 630 A					

Motorized operating mechanisms

Motorized operating mechanisms	Lateral motor operator (MO310)				Article No.	Price per PU	PU (UNIT, SET, M)	PS*/ P. unit	PG
	24 ... 60 V DC	42 ... 60 V AC	110 ... 230 V AC, 110 ... 250 V DC						
 3VA9267-0HB10	✓	--	--	--	3VA9117-0HB10		1	1 unit	1CB
	✓	--	--	--	3VA9117-0HB20		1	1 unit	1CB
 3VA9267-0HA10	Motor operators without stored energy feature (MO320)				Article No.	Price per PU	PU (UNIT, SET, M)	PS*/ P. unit	PG
	Versions								
	✓	--	--	--	3VA9157-0HA10		1	1 unit	1CB
	--	✓	--	--	3VA9257-0HA10		1	1 unit	1CB
	--	--	✓	--	3VA9267-0HA10		1	1 unit	1CB
	--	--	--	✓	3VA9467-0HA10		1	1 unit	1CB
	✓	--	--	--	3VA9157-0HA20		1	1 unit	1CB
	--	✓	--	--	3VA9257-0HA20		1	1 unit	1CB
--	--	✓	--	3VA9267-0HA20		1	1 unit	1CB	
--	--	--	✓	3VA9467-0HA20		1	1 unit	1CB	

Overview

The proper functioning and in particular the safety of electrical installations does not just depend on the quality and design of the components, but also on the method of installation.

The following aspects of electrical installations are of crucial importance for the implementation of a safe, properly functioning connection to the 3VA molded case circuit breakers:

- Installation, e.g. connection to cables or busbars
- Dimensioning of the cables and busbars
- Installation medium, e.g. rigid or flexible

The following catalog pages provide all the information needed to ensure that a 3VA molded case circuit breaker is safely connected.

Connection technology for the 3VA molded case circuit breaker

The connection technology of the 3VA molded case circuit breaker is designed to support uncomplicated and convenient commissioning of the 3VA molded case circuit breakers and to meet all installation requirements.

To meet this objective, an extensive portfolio of connection components is available.

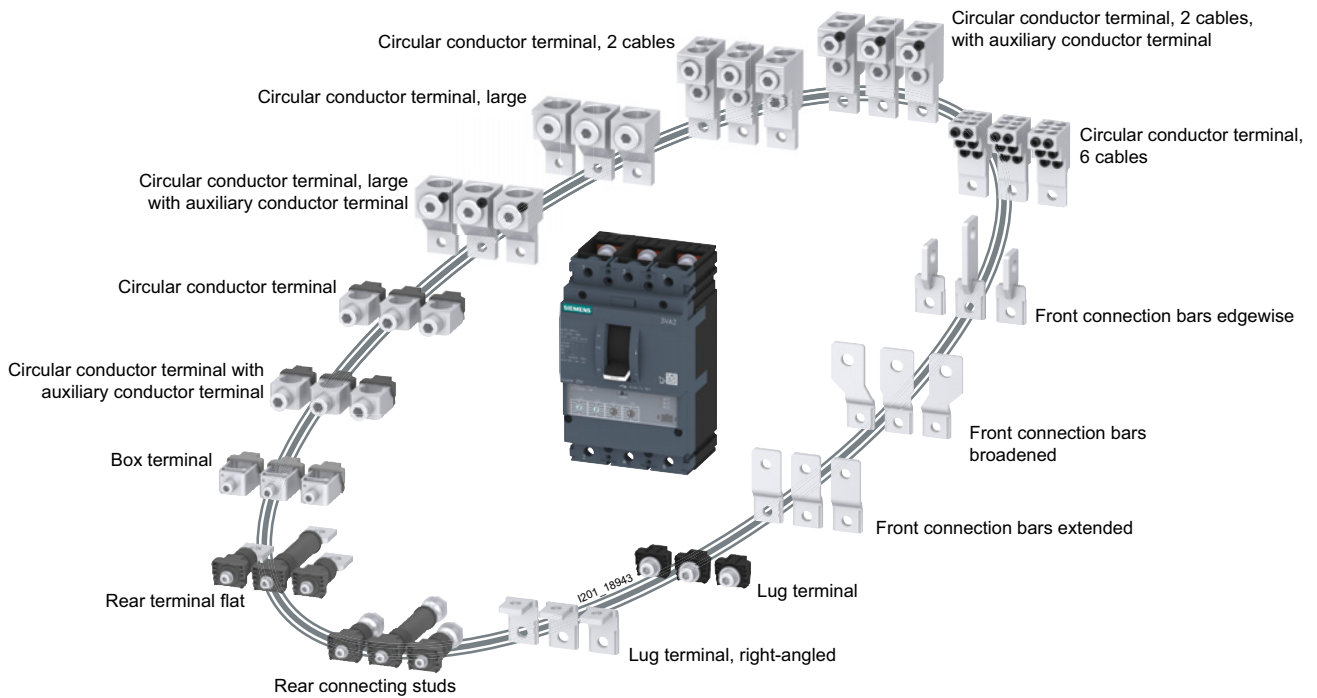





Molded Case Circuit Breakers

3VA Molded Case Circuit Breakers – Accessories, IEC **NEW**

Connection technology

Conductor cross-sections

Connection technology	Cable medium	Cables and busbars	Dimensions	3VA1		3VA2		
				100 A/160 A	250 A	100 A/160 A/250 A	400 A	630 A
 Box terminal	Solid cable	Cu cable	mm ²	1.5 ... 16	6 ... 16	6 ... 16	--	--
	Stranded cable	Cu cable	mm ²	1.5 ... 70	6 ... 120 50 ... 185	6 ... 120 25 ... 185	35 ... 300	35 ... 300
	Finely stranded cable	Cu cable	mm ²	1.5 ... 50	10 ... 95 95 ... 150	10 ... 95 35 ... 150	25 ... 240	25 ... 240
	Finely stranded with insulated end sleeve	Cu cable	mm ²	1.5 ... 50	6 ... 95 50 ... 150	6 ... 95 25 ... 150	25 ... 240	25 ... 240
	Flexible copper busbar	Flexible busbar	mm x mm		2x ..6x [13 x 0.5] ... 2x ..9x [9 x 0.8]	2x ..6x [13 x 0.5] ... 2x ..6x [15.5 x 0.8] ... 2x ..6x [20 x 1]	2x ..6x [13 x 0.5] ... 2x ..6x [15.5 x 0.8] ... 2x ..6x [20 x 1]	2x ..10x [20 x 1] ... 2x ..10x [24 x 1]
 Circular conductor terminals	Solid cable	Cu/Al cable	mm ²	2.5/4 ... 16	--	1.5/4 ... 16	--	--
	Stranded cable	Cu/Al cable	mm ²	1.5/4 ... 50	35 ... 185	1.5/4 ... 50 16 ... 185	50 ... 300	--
	Finely stranded cable	Cu cable	mm ²	1.5 ... 35	35 ... 150	1.5 ... 35 25 ... 150	50 ... 240	--
	Finely stranded with insulated end sleeve	Cu cable	mm ²	1.5 ... 35	35 ... 150	1.5 ... 35 16 ... 120	50 ... 240	--
 Circular conductor terminal, large	Solid cable			--	--	--	--	--
	Stranded cable	Cu/Al cable	mm ²	25 ... 150	50 ... 240	50 ... 240	--	--
	Finely stranded cable	Cu cable	mm ²	25 ... 120	50 ... 185	50 ... 185	--	--
	Finely stranded with insulated end sleeve	Cu cable	mm ²	25 ... 95	50 ... 185	50 ... 185	--	--
 Circular conductor terminal for 2 cables	Solid cable			--	--	--	--	--
	Stranded cable	Cu/Al cable	mm ²	--	25 ... 150	25 ... 150	70 ... 300	70 ... 300
	Finely stranded cable	Cu cable	mm ²	--	25 ... 150	25 ... 150	70 ... 240	70 ... 240
	Finely stranded with insulated end sleeve	Cu cable	mm ²	--	25 ... 70	25 ... 70	70 ... 185	70 ... 185
 Circular conductor terminal for 6 cables	Solid cable	Cu/Al cable	mm ²	1.5/4 ... 16	1.5/4 ... 16	1.5/4 ... 16	1.5/4 ... 16	1.5/4 ... 16
	Stranded cable	Cu/Al cable	mm ²	1.5/4 ... 35	1.5/4 ... 35	1.5/4 ... 35	1.5/4 ... 35	1.5/4 ... 35
	Finely stranded cable	Cu cable	mm ²	1.5 ... 25	1.5 ... 25	1.5 ... 25	1.5 ... 25	1.5 ... 25
	Finely stranded with insulated end sleeve	Cu cable	mm ²	1.5 ... 25	1.5 ... 25	1.5 ... 25	1.5 ... 25	1.5 ... 25
Busbar connection	Direct (width x height)	Busbar	mm x mm	17 x 6.5	25 x 8	25 x 8	35 x 10	35 x 10
	Front connection bars extended	Busbar	mm x mm	22 x 8	32 x 10	32 x 10	40 x 12.5	40 x 12.5
	Front connection bars broadened	Busbar	mm x mm	30 x 8	35 x 10	35 x 10	60 x 12.5	60 x 12.5

Further connection accessories

Insulation / auxiliary conductor connections

The connection accessories portfolio includes an extensive selection of insulating components (phase barriers, terminal

covers, etc.). Auxiliary conductor connections for box terminals and busbars are also available.

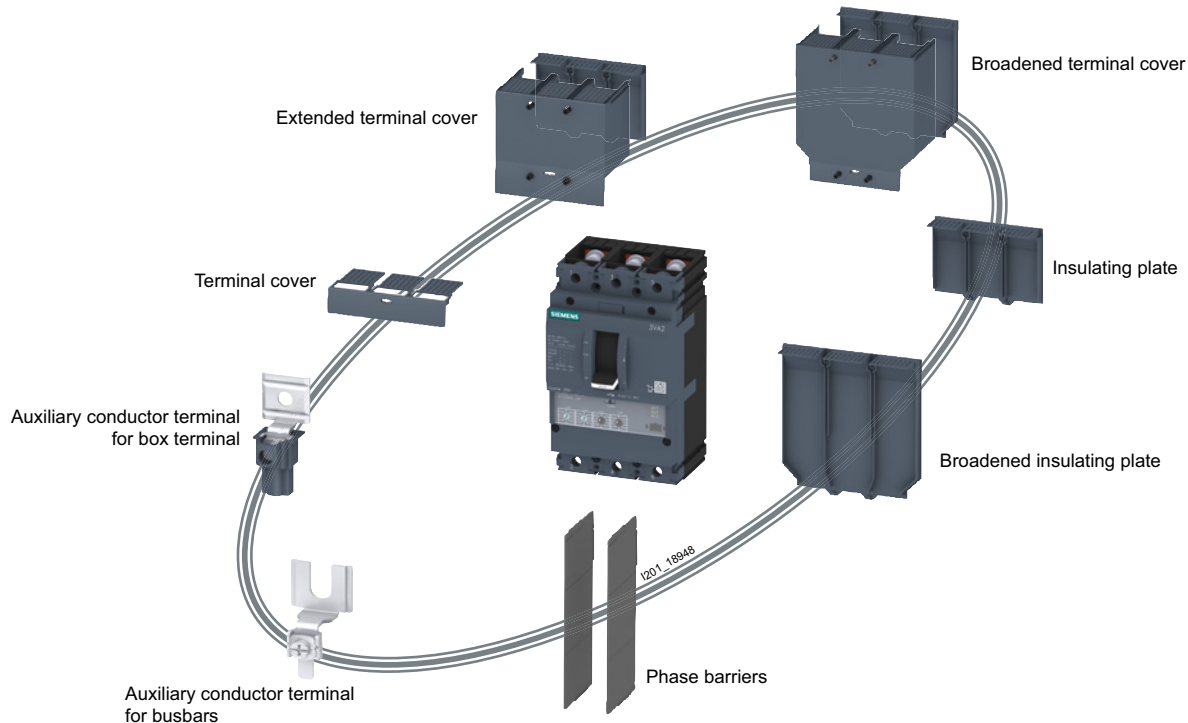

Terminal covers

Terminal covers are insulating and sealable insulation accessories which protect against accidental contact with main current paths. When mounted on the circuit breaker, terminal covers at the front provide degree of protection IP4x and when correctly installed at the infeed and load ends of the breaker, degree of protection IP2x. All terminal covers have a recess on the inside face which can be drilled out if necessary so that safe isolation can be afforded by commercially available voltage detectors.

- Short terminal covers are normally installed for all types of front termination which do not exceed the geometric dimensions of the molded-case circuit breaker (the termination area) (e.g. box terminal, lug terminal, etc.).
- Extended terminal covers are required when bar extensions or external terminals (i.e. terminals which exceed the dimensions of the termination area of the molded case circuit breaker) are installed. The extended terminal cover consists of two parts, an insulating plate and the top half of the terminal cover. Both parts are attached by screws and thus afford the degrees of protection specified above.
- Broad terminal covers are required when broadened connection bars are installed. The extended terminal cover consists of two parts, a broadened insulating plate and the top half of the terminal cover. Both parts are attached by screws and thus afford the degrees of protection specified above.

Insulating plates

The purpose of insulating plates is to insulate the main terminals of the molded case circuit breaker from the mounting plate (cubicle).

- Insulating plate: in combination with bar extensions, for example
- Insulating plate broadened: in combination with broadened connection bars, for example

Auxiliary conductor terminals

All circular conductor terminals can be ordered with or without auxiliary conductor terminal (see page 2/10, Front terminals). The following accessories are available to allow the implementation of an auxiliary conductor terminal in combination with a box terminal or busbar connection:

- Auxiliary conductor terminal for box terminal: This terminal is fastened by screws in the box terminal with the cable.
- Auxiliary conductor terminal for busbars: This terminal is attached by screws directly to the busbar.

All auxiliary conductor terminals are rated for a maximum load of 6 A. Cables of up to 2.5 mm² can be connected.

Benefits

- High degree of flexibility
- Cables and busbars can be connected quickly and easily to the 3VA molded case circuit breaker
- Extensive selection of connection accessories

Molded Case Circuit Breakers

3VA Molded Case Circuit Breakers – Accessories, IEC **NEW**

Connection parts – suitable for all installation types (fixed mounting, plug-in and draw-out versions)





Selection and ordering data

Version	Minimum mm ² for stranded cable	Maximum mm ² for stranded cable	For molded case circuit breakers/frame size				DT	Article No. www.siemens.com/product?Article No.	Price per PU	PU (UNIT, SET, M)	PS*/P. unit	PG
			3VA1 100 A 160 A	3VA1 250 A	3VA2 100 A 160 A 250 A	3VA2 400 A 630 A						

Box terminals suitable for all installation types (fixed mounting, plug-in and draw-out versions)

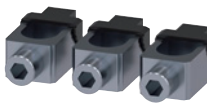

 3VA9163-0JA12 Box terminal • Connection of Cu cable • Included in scope of supply: 3 single terminals	1.5 mm ²	70 mm ²	✓	--	--	--	3VA9153-0JA11	1	1 unit	1CB
	6 mm ²	120 mm ²	--	✓	--	--	3VA9253-0JA11	1	1 unit	1CB
	50 mm ²	185 mm ²	--	✓	--	--	3VA9253-0JA12	1	1 unit	1CB
	6 mm ²	120 mm ²	--	--	✓	--	3VA9163-0JA12	1	1 unit	1CB
	25 mm ²	185 mm ²	--	--	✓	--	3VA9263-0JA12	1	1 unit	1CB
	35 mm ²	300 mm ²	--	--	--	✓	3VA9483-0JA13	1	1 unit	1CB
 3VA9164-0JA12 Box terminal • Connection of Cu cable • Included in scope of supply: 4 single terminals	1.5 mm ²	70 mm ²	✓	--	--	--	3VA9154-0JA11	1	1 unit	1CB
	6 mm ²	120 mm ²	--	✓	--	--	3VA9254-0JA11	1	1 unit	1CB
	50 mm ²	185 mm ²	--	✓	--	--	3VA9254-0JA12	1	1 unit	1CB
	6 mm ²	120 mm ²	--	--	✓	--	3VA9164-0JA12	1	1 unit	1CB
	25 mm ²	185 mm ²	--	--	✓	--	3VA9264-0JA12	1	1 unit	1CB
	35 mm ²	300 mm ²	--	--	--	✓	3VA9484-0JA13	1	1 unit	1CB

Circular conductor terminals suitable for all installation types (fixed mounting, plug-in and draw-out versions)







 3VA9103-0JB11 Circular conductor terminals • Connection of Cu/Al cable • Included in scope of supply: 3 single terminals	1.5 mm ²	50 mm ²	✓	--	--	--	3VA9113-0JB11	1	1 unit	1CB
	35 mm ²	185 mm ²	--	✓	--	--	3VA9253-0JB12	1	1 unit	1CB
	1.5 mm ²	50 mm ²	--	--	✓	--	3VA9103-0JB11	1	1 unit	1CB
	16 mm ²	185 mm ²	--	--	✓	--	3VA9263-0JB12	1	1 unit	1CB
	50 mm ²	300 mm ²	--	--	--	✓	3VA9383-0JB13	1	1 unit	1CB
 3VA9104-0JB11 Circular conductor terminals • Connection of Cu/Al cable • Included in scope of supply: 4 single terminals	1.5 mm ²	50 mm ²	✓	--	--	--	3VA9114-0JB11	1	1 unit	1CB
	35 mm ²	185 mm ²	--	✓	--	--	3VA9254-0JB12	1	1 unit	1CB
	1.5 mm ²	50 mm ²	--	--	✓	--	3VA9104-0JB11	1	1 unit	1CB
	16 mm ²	185 mm ²	--	--	✓	--	3VA9264-0JB12	1	1 unit	1CB
	50 mm ²	300 mm ²	--	--	--	✓	3VA9384-0JB13	1	1 unit	1CB
 3VA9103-0JG11 Circular conductor terminal with auxiliary conductor terminal • Connection of Cu/Al cable • Included in scope of supply: 3 single terminals	16 mm ²	50 mm ²	✓	--	--	--	3VA9113-0JG11	1	1 unit	1CB
	35 mm ²	185 mm ²	--	✓	--	--	3VA9253-0JG12	1	1 unit	1CB
	1.5 mm ²	50 mm ²	--	--	✓	--	3VA9103-0JG11	1	1 unit	1CB
	16 mm ²	185 mm ²	--	--	✓	--	3VA9263-0JG12	1	1 unit	1CB
	50 mm ²	300 mm ²	--	--	--	✓	3VA9383-0JG13	1	1 unit	1CB
 3VA9104-0JG11 Circular conductor terminal with auxiliary conductor terminal • Connection of Cu/Al cable • Included in scope of supply: 4 single terminals	16 mm ²	50 mm ²	✓	--	--	--	3VA9114-0JG11	1	1 unit	1CB
	35 mm ²	185 mm ²	--	✓	--	--	3VA9254-0JG12	1	1 unit	1CB
	1.5 mm ²	50 mm ²	--	--	✓	--	3VA9104-0JG11	1	1 unit	1CB
	16 mm ²	185 mm ²	--	--	✓	--	3VA9264-0JG12	1	1 unit	1CB
	50 mm ²	300 mm ²	--	--	--	✓	3VA9384-0JG13	1	1 unit	1CB

Version	Max. terminal width	Max. busbar thickness	For molded case circuit breakers/frame size				DT	Article No. www.siemens.com/product?Article No.	Price per PU	PU (UNIT, SET, M)	PS*/P. unit	PG
			3VA1 100 A 160 A	3VA1 250 A	3VA2 100 A 160 A 250 A	3VA2 400 A 630 A						

Lug terminals suitable for all installation types (fixed mounting, plug-in and draw-out versions)

 3VA9203-0QA00 Lug terminal Included in scope of supply: • 3 single terminals	17 mm	6.5 mm	✓	--	--	--	3VA9113-0QA00	1	1 unit	1CB
	25 mm	8 mm	--	✓	--	--	3VA9213-0QA00	1	1 unit	1CB
	25 mm	8 mm	--	--	✓	--	3VA9203-0QA00	1	1 unit	1CB
	35 mm	10 mm	--	--	--	✓	3VA9403-0QA00	1	1 unit	1CB
 3VA9204-0QA00 Lug terminal Included in scope of supply: • 4 single terminals	17 mm	6.5 mm	✓	--	--	--	3VA9114-0QA00	1	1 unit	1CB
	25 mm	8 mm	--	✓	--	--	3VA9214-0QA00	1	1 unit	1CB
	25 mm	8 mm	--	--	✓	--	3VA9204-0QA00	1	1 unit	1CB
	35 mm	10 mm	--	--	--	✓	3VA9404-0QA00	1	1 unit	1CB

Connection parts – suitable for all installation types (fixed mounting, plug-in and draw-out versions)



Version	Max. terminal width	Max. busbar thickness	For molded case circuit breakers/frame size				DT	Article No. www.siemens.com/product?Article No.	Price per PU	PU (UNIT, SET, M)	PS* / P. unit	PG
			3VA1 100 A 160 A	3VA1 250 A	3VA2 100 A 160 A 250 A	3VA2 400 A 630 A						
Bar extensions suitable for all installation types (fixed mounting, plug-in and draw-out versions)												
 3VA9263-0QB00	Front connection bars extended Included in scope of supply: • 3 single terminals • 2 phase barriers	22 mm	8 mm	✓	--	--	--	3VA9153-0QB00		1	1 unit	1CB
		32 mm	10 mm	--	✓	--	--	3VA9253-0QB00		1	1 unit	1CB
		32 mm	10 mm	--	--	✓	--	3VA9263-0QB00		1	1 unit	1CB
		40 mm	12.5 mm	--	--	--	✓	3VA9483-0QB00		1	1 unit	1CB
 3VA9264-0QB00	Front connection bars extended Included in scope of supply: • 4 single terminals • 3 phase barriers	22 mm	8 mm	✓	--	--	--	3VA9154-0QB00		1	1 unit	1CB
		32 mm	10 mm	--	✓	--	--	3VA9254-0QB00		1	1 unit	1CB
		32 mm	10 mm	--	--	✓	--	3VA9264-0QB00		1	1 unit	1CB
		40 mm	12.5 mm	--	--	--	✓	3VA9484-0QB00		1	1 unit	1CB
 3VA9263-0QC00	Front connection bars broadened Included in scope of supply: • 3 single terminals • 2 phase barriers Distance between pole centers: 100/160 A = 35 mm 250 A = 45 mm 400/630 A = 70 mm	30 mm	8 mm	✓	--	--	--	3VA9153-0QC00		1	1 unit	1CB
		35 mm	10 mm	--	✓	--	--	3VA9253-0QC00		1	1 unit	1CB
		35 mm	10 mm	--	--	✓	--	3VA9263-0QC00		1	1 unit	1CB
		60 mm	12.5 mm	--	--	--	✓	3VA9483-0QC00		1	1 unit	1CB
 3VA9264-0QC00	Front connection bars broadened Included in scope of supply: • 4 single terminals • 3 phase barriers Distance between pole centers: 100/160 A = 35 mm 250 A = 45 mm 400/630 A = 70 mm	30 mm	8 mm	✓	--	--	--	3VA9154-0QC00		1	1 unit	1CB
		35 mm	10 mm	--	✓	--	--	3VA9254-0QC00		1	1 unit	1CB
		35 mm	10 mm	--	--	✓	--	3VA9264-0QC00		1	1 unit	1CB
		60 mm	12.5 mm	--	--	--	✓	3VA9484-0QC00		1	1 unit	1CB
 3VA9263-0QD00	Front connection bars edgewise Included in scope of supply: • 3 single terminals • 2 phase barriers	20 mm	6 mm	✓	--	--	--	3VA9153-0QD00		1	1 unit	1CB
		25 mm	7 mm	--	✓	--	--	3VA9253-0QD00		1	1 unit	1CB
		25 mm	7 mm	--	--	✓	--	3VA9263-0QD00		1	1 unit	1CB
		40 mm	8 mm	--	--	--	✓	3VA9483-0QD00		1	1 unit	1CB
 3VA9264-0QD00	Front connection bars edgewise Included in scope of supply: • 4 single terminals • 3 phase barriers	20 mm	6 mm	✓	--	--	--	3VA9154-0QD00		1	1 unit	1CB
		25 mm	7 mm	--	✓	--	--	3VA9254-0QD00		1	1 unit	1CB
		25 mm	7 mm	--	--	✓	--	3VA9264-0QD00		1	1 unit	1CB
		40 mm	8 mm	--	--	--	✓	3VA9484-0QD00		1	1 unit	1CB

Molded Case Circuit Breakers





3VA Molded Case Circuit Breakers – Accessories, IEC **NEW**

Connection parts – suitable for all installation types (fixed mounting, plug-in and draw-out versions)

2

Version	Max. terminal width	Max. busbar thickness	For molded case circuit breakers/frame size				DT	Article No. www.siemens.com/product?Article.No.	Price per PU	PU (UNIT, SET, M)	PS*/P. unit	PG
			3VA1 100 A 160 A	3VA1 250 A	3VA2 100 A 160 A 250 A	3VA2 400 A 630 A						
 3VA9223-0QG00 Lug terminal, right-angled¹⁾ Included in scope of supply: • 3 single terminals • 2 phase barriers	22 mm	8 mm	✓	--	--	--	3VA9113-0QG00		1	1 unit	1CB	
	32 mm	10 mm	--	✓	--	--	3VA9213-0QG00		1	1 unit	1CB	
	32 mm	10 mm	--	--	✓	--	3VA9223-0QG00		1	1 unit	1CB	
	40 mm	12.5 mm	--	--	--	✓	3VA9403-0QG00		1	1 unit	1CB	
 3VA9224-0QG00 Lug terminal, right-angled¹⁾ Included in scope of supply: • 4 single terminals • 3 phase barriers	22 mm	8 mm	✓	--	--	--	3VA9114-0QG00		1	1 unit	1CB	
	32 mm	10 mm	--	✓	--	--	3VA9214-0QG00		1	1 unit	1CB	
	32 mm	10 mm	--	--	✓	--	3VA9224-0QG00		1	1 unit	1CB	
	40 mm	12.5 mm	--	--	--	✓	3VA9404-0QG00		1	1 unit	1CB	

¹⁾ Can only be connected to breaker side N, 1, 3, 5

Version	For molded case circuit breakers/frame size	DT	Article No. www.siemens.com/product?Article.No.	Price per PU	PU (UNIT, SET, M)	PS*/P. unit	PG	
								3VA1 100 A 160 A
Rear flat terminals suitable for all installation types (fixed mounting, plug-in and draw-out versions)								
 3VA9203-0QE00 Rear terminal flat Included in scope of supply: • 2 short terminals flat • 1 long terminal flat	✓	--	--	--	3VA9113-0QE00	1	1 unit	1CB
	--	✓	--	--	3VA9213-0QE00	1	1 unit	1CB
	--	--	✓	--	3VA9203-0QE00	1	1 unit	1CB
	--	--	--	✓	3VA9403-0QE00	1	1 unit	1CB
 3VA9204-0QE00 Rear terminal flat Included in scope of supply: • 2 short terminals flat • 2 long terminals flat	✓	--	--	--	3VA9114-0QE00	1	1 unit	1CB
	--	✓	--	--	3VA9214-0QE00	1	1 unit	1CB
	--	--	✓	--	3VA9204-0QE00	1	1 unit	1CB
	--	--	--	✓	3VA9404-0QE00	1	1 unit	1CB
 3VA9201-0QE10 Rear terminal flat Included in scope of supply: • 1 short terminal flat	✓	--	--	--	3VA9111-0QE10	1	1 unit	1CB
	--	✓	--	--	3VA9211-0QE10	1	1 unit	1CB
	--	--	✓	--	3VA9201-0QE10	1	1 unit	1CB
	--	--	--	✓	3VA9401-0QE10	1	1 unit	1CB
 3VA9201-0QE20 Rear terminal flat Included in scope of supply: • 1 long terminal flat	✓	--	--	--	3VA9111-0QE20	1	1 unit	1CB
	--	✓	--	--	3VA9211-0QE20	1	1 unit	1CB
	--	--	✓	--	3VA9201-0QE20	1	1 unit	1CB
	--	--	--	✓	3VA9401-0QE20	1	1 unit	1CB

Connection parts – suitable for all installation types (fixed mounting, plug-in and draw-out versions)







Version	For molded case circuit breakers/frame size				DT	Article No. www.siemens.com/product?Article No.	Price per PU	PU (UNIT, SET, M)	PS*/P. unit	PG
	3VA1 100 A 160 A	3VA1 250 A	3VA2 100 A 160 A 250 A	3VA2 400 A 630 A						
Rear connecting stud terminals suitable for all installation types (fixed mounting, plug-in and draw-out versions)										
 3VA9203-0QF00	Rear connecting stud Included in scope of supply: • 1 long connecting stud • 2 short connecting studs		✓	--	--	--	3VA9113-0QF00	1	1 unit	1CB
			--	✓	--	--	3VA9213-0QF00	1	1 unit	1CB
			--	--	✓	--	3VA9203-0QF00	1	1 unit	1CB
			--	--	--	✓	3VA9403-0QF00	1	1 unit	1CB
 3VA9204-0QF00	Rear connecting stud Included in scope of supply: • 2 long connecting studs • 2 short connecting studs		✓	--	--	--	3VA9114-0QF00	1	1 unit	1CB
			--	✓	--	--	3VA9214-0QF00	1	1 unit	1CB
			--	--	✓	--	3VA9204-0QF00	1	1 unit	1CB
			--	--	--	✓	3VA9404-0QF00	1	1 unit	1CB
 3VA9201-0QF10	Rear connecting stud Included in scope of supply: • 1 short connecting stud		✓	--	--	--	3VA9111-0QF10	1	1 unit	1CB
			--	✓	--	--	3VA9211-0QF10	1	1 unit	1CB
			--	--	✓	--	3VA9201-0QF10	1	1 unit	1CB
			--	--	--	✓	3VA9401-0QF10	1	1 unit	1CB
 3VA9111-0QF20	Rear connecting stud Included in scope of supply: • 1 long connecting stud		✓	--	--	--	3VA9111-0QF20	1	1 unit	1CB
			--	✓	--	--	3VA9211-0QF20	1	1 unit	1CB
			--	--	✓	--	3VA9201-0QF20	1	1 unit	1CB
			--	--	--	✓	3VA9401-0QF20	1	1 unit	1CB
Phase barriers suitable for all installation types (fixed mounting, plug-in and draw-out versions)										
 3VA9262-0WA00	Phase barriers Included in scope of supply: • 2 phase barriers		✓	--	--	--	3VA9152-0WA00	1	1 unit	1CB
			--	✓	--	--	3VA9252-0WA00	1	1 unit	1CB
			--	--	✓	--	3VA9262-0WA00	1	1 unit	1CB
			--	--	--	✓	3VA9482-0WA00	1	1 unit	1CB

Molded Case Circuit Breakers

3VA Molded Case Circuit Breakers – Accessories, IEC **NEW**

Connection parts – specially for fixed mounting

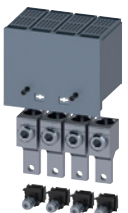
2







Version	Minimum mm ² for stranded cable	Maximum mm ² for stranded cable	For molded case circuit breakers/frame size				DT	Article No. www.siemens.com/product?Article No.	Price per PU	PU (UNIT, SET, M)	PS*/P. unit	PG
			3VA1 100 A 160 A	3VA1 250 A	3VA2 100 A 160 A 250 A	3VA2 400 A 630 A						
Front connection bars specially for fixed mounting												
 Front connection bars extended Included in scope of supply: • 1 busbar connection piece	32 mm	10 mm	✓	--	--	--	3VA9151-QQB00			1	1 unit	1CB
 Front connection bars broadened Included in scope of supply: • 2 individual busbar connection pieces • 1 phase barriers Note Distance between pole centers 44.6 mm	35 mm	10 mm	✓	--	--	--	3VA9152-QQC00			1	1 unit	1CB
Circular conductor terminals specially for fixed mounting												
 Circular conductor terminal, large • Connection of Cu/Al cable • Included in scope of supply: 2 single terminals and 1 extended terminal cover	25 mm ²	150 mm ²	✓	--	--	--	3VA9112-0JJ12			1	1 unit	1CB
 Circular conductor terminal, large • Connection of Cu/Al cable • Included in scope of supply: 3 single terminals and 1 extended terminal cover	25 mm ²	150 mm ²	✓	--	--	--	3VA9113-0JJ12			1	1 unit	1CB
	50 mm ²	240 mm ²	--	✓	--	--	3VA9213-0JJ13			1	1 unit	1CB
	50 mm ²	240 mm ²	--	--	✓	--	3VA9223-0JJ13			1	1 unit	1CB
 Circular conductor terminal, large • Connection of Cu/Al cable • Included in scope of supply: 4 single terminals and 1 extended terminal cover	25 mm ²	150 mm ²	✓	--	--	--	3VA9114-0JJ12			1	1 unit	1CB
	50 mm ²	240 mm ²	--	✓	--	--	3VA9214-0JJ13			1	1 unit	1CB
	50 mm ²	240 mm ²	--	--	✓	--	3VA9224-0JJ13			1	1 unit	1CB
 Circular conductor terminal, large, with auxiliary conductor terminal • Connection of Cu/Al cable • Included in scope of supply: 2 single terminals and 1 extended terminal cover	25 mm ²	150 mm ²	✓	--	--	--	3VA9112-0JC12			1	1 unit	1CB

Molded Case Circuit Breakers

NEW 3VA Molded Case Circuit Breakers – Accessories, IEC

Connection parts – specially for fixed mounting

2

Version	Minimum mm ² for stranded cable	Maximum mm ² for stranded cable	For molded case circuit breakers/frame size				DT	Article No. www.siemens.com/product?Article No.	Price per PU	PU (UNIT, SET, M)	PS*/P. unit	PG
			3VA1 100 A 160 A	3VA1 250 A	3VA2 100 A 160 A 250 A	3VA2 400 A 630 A						
 3VA9223-0JC13 Circular conductor terminal, large, with auxiliary conductor terminal • Connection of Cu/Al cable • Included in scope of supply: 3 single terminals and 1 extended terminal cover	25 mm ²	150 mm ²	✓	--	--	--	3VA9113-0JC12		1	1 unit	1CB	
	50 mm ²	240 mm ²	--	✓	--	--	3VA9213-0JC13		1	1 unit	1CB	
	50 mm ²	240 mm ²	--	--	✓	--	3VA9223-0JC13		1	1 unit	1CB	
 3VA9114-0JC12 Circular conductor terminal, large, with auxiliary conductor terminal • Connection of Cu/Al cable • Included in scope of supply: 4 single terminals and 1 extended terminal cover	25 mm ²	150 mm ²	✓	--	--	--	3VA9114-0JC12		1	1 unit	1CB	
	50 mm ²	240 mm ²	--	✓	--	--	3VA9214-0JC13		1	1 unit	1CB	
	50 mm ²	240 mm ²	--	--	✓	--	3VA9224-0JC13		1	1 unit	1CB	
 3VA9223-0JJ22 Circular conductor terminal, 2 cables • Connection of Cu/Al cable • Included in scope of supply: 3 single terminals and 1 extended terminal cover	2 x 25 mm ²	2 x 150 mm ²	--	✓	--	--	3VA9213-0JJ22		1	1 unit	1CB	
	2 x 25 mm ²	2 x 150 mm ²	--	--	✓	--	3VA9223-0JJ22		1	1 unit	1CB	
	2 x 70 mm ²	2 x 300 mm ²	--	--	--	✓	3VA9403-0JJ23		1	1 unit	1CB	
 3VA9224-0JJ22 Circular conductor terminal, 2 cables • Connection of Cu/Al cable • Included in scope of supply: 4 single terminals and 1 extended terminal cover	2 x 25 mm ²	2 x 150 mm ²	--	✓	--	--	3VA9214-0JJ22		1	1 unit	1CB	
	2 x 25 mm ²	2 x 150 mm ²	--	--	✓	--	3VA9224-0JJ22		1	1 unit	1CB	
	2 x 70 mm ²	2 x 300 mm ²	--	--	--	✓	3VA9404-0JJ23		1	1 unit	1CB	
 3VA9223-0JC22 Circular conductor terminal, 2 cables, with auxiliary conductor terminal • Connection of Cu/Al cable • Included in scope of supply: 3 single terminals and 1 extended terminal cover	2 x 25 mm ²	2 x 150 mm ²	--	✓	--	--	3VA9213-0JC22		1	1 unit	1CB	
	2 x 25 mm ²	2 x 150 mm ²	--	--	✓	--	3VA9223-0JC22		1	1 unit	1CB	
	2 x 70 mm ²	2 x 300 mm ²	--	--	--	✓	3VA9403-0JC23		1	1 unit	1CB	
 3VA9224-0JC22 Circular conductor terminal, 2 cables, with auxiliary conductor terminal • Connection of Cu/Al cable • Included in scope of supply: 4 single terminals and 1 extended terminal cover	2 x 25 mm ²	2 x 150 mm ²	--	✓	--	--	3VA9214-0JC22		1	1 unit	1CB	
	2 x 25 mm ²	2 x 150 mm ²	--	--	✓	--	3VA9224-0JC22		1	1 unit	1CB	
	2 x 70 mm ²	2 x 300 mm ²	--	--	--	✓	3VA9404-0JC23		1	1 unit	1CB	
 3VA9112-0JF60 Circular conductor terminal, 6 cables • Connection of Cu/Al cable • Included in scope of supply: 2 single terminals and 1 extended terminal cover	6 x 1.5 mm ²	6 x 35 mm ²	✓	--	--	--	3VA9112-0JF60		1	1 unit	1CB	



* You can order this quantity or a multiple thereof.

Molded Case Circuit Breakers





3VA Molded Case Circuit Breakers – Accessories, IEC **NEW**





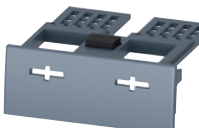

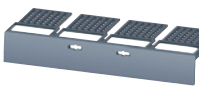
Connection parts – specially for fixed mounting

2

Version	Minimum mm ² for stranded cable	Maximum mm ² for stranded cable	For molded case circuit breakers/frame size				DT	Article No. www.siemens.com/product?Article No.	Price per PU	PU (UNIT, SET, M)	PS*/P. unit	PG
			3VA1 100 A 160 A	3VA1 250 A	3VA2 100 A 160 A 250 A	3VA2 400 A 630 A						
 Circular conductor terminal, 6 cables • Connection of Cu/Al cable • Included in scope of supply: 3 single terminals and 1 extended terminal cover 3VA9223-0JF60	6 x 1.5 mm ²	6 x 35 mm ²	✓	--	--	--	3VA9113-0JF60		1	1 unit	1CB	
			--	✓	--	--	3VA9213-0JF60		1	1 unit	1CB	
			--	--	✓	--	3VA9223-0JF60		1	1 unit	1CB	
			--	--	--	✓	3VA9303-0JF60		1	1 unit	1CB	
 Circular conductor terminal, 6 cables • Connection of Cu/Al cable • Included in scope of supply: 4 single terminals and 1 extended terminal cover 3VA9224-0JF60	6 x 1.5 mm ²	6 x 35 mm ²	✓	--	--	--	3VA9114-0JF60		1	1 unit	1CB	
			--	✓	--	--	3VA9214-0JF60		1	1 unit	1CB	
			--	--	✓	--	3VA9224-0JF60		1	1 unit	1CB	
			--	--	--	✓	3VA9304-0JF60		1	1 unit	1CB	

Version	For molded case circuit breakers/frame size	DT	Article No. www.siemens.com/product?Article No.	Price per PU	PU (UNIT, SET, M)	PS*/P. unit	PG
	3VA1 100 A 160 A	3VA1 250 A	3VA2 100 A 160 A 250 A	3VA2 400 A 630 A			

Terminal covers specially for fixed mounting											
Version	For molded case circuit breakers/frame size	DT	Article No. www.siemens.com/product?Article No.	Price per PU	PU (UNIT, SET, M)	PS*/P. unit	PG				
	3VA1 100 A 160 A	3VA1 250 A	3VA2 100 A 160 A 250 A	3VA2 400 A 630 A							
 Terminal cover for 1-pole breakers 3VA9111-0WD10	✓	--	--	--	3VA9111-0WD10	1	1 unit	1CB			
 Terminal cover for 2-pole breakers 3VA9111-0WD20	✓	--	--	--	3VA9111-0WD20	1	1 unit	1CB			
 Terminal cover for 3-pole breakers 3VA9221-0WD30	✓	--	--	--	3VA9111-0WD30	1	1 unit	1CB			
	--	✓	--	--	3VA9211-0WD30	1	1 unit	1CB			
	--	--	✓	--	3VA9221-0WD30	1	1 unit	1CB			
	--	--	--	✓	3VA9481-0WD30	1	1 unit	1CB			
 Terminal cover for 4-pole breakers 3VA9221-0WD40	✓	--	--	--	3VA9111-0WD40	1	1 unit	1CB			
	--	✓	--	--	3VA9211-0WD40	1	1 unit	1CB			
	--	--	✓	--	3VA9221-0WD40	1	1 unit	1CB			
	--	--	--	✓	3VA9481-0WD40	1	1 unit	1CB			
 Extended terminal cover, 2-pole 3VA9111-0WF20	✓	--	--	--	3VA9111-0WF20	1	1 unit	1CB			

Version	For molded case circuit breakers/frame size				DT	Article No. www.siemens.com/product?Article No.	Price per PU	PU (UNIT, SET, M)	PS*/P. unit	PG
	3VA1 100 A 160 A	3VA1 250 A	3VA2 100 A 160 A 250 A	3VA2 400 A 630 A						
 3VA9221-0WF30	Extended terminal cover for 3-pole breakers	✓	--	--	--	3VA9111-0WF30		1	1 unit	1CB
		--	✓	--	--	3VA9211-0WF30		1	1 unit	1CB
		--	--	✓	--	3VA9221-0WF30		1	1 unit	1CB
		--	--	--	✓	3VA9481-0WF30		1	1 unit	1CB
 3VA9221-0WF40	Extended terminal cover for 4-pole breakers	✓	--	--	--	3VA9111-0WF40		1	1 unit	1CB
		--	✓	--	--	3VA9211-0WF40		1	1 unit	1CB
		--	--	✓	--	3VA9221-0WF40		1	1 unit	1CB
		--	--	--	✓	3VA9481-0WF40		1	1 unit	1CB
 3VA9221-0WG30	Broadened terminal cover for 3-pole breakers	✓	--	--	--	3VA9111-0WG30		1	1 unit	1CB
		--	✓	--	--	3VA9211-0WG30		1	1 unit	1CB
		--	--	✓	--	3VA9221-0WG30		1	1 unit	1CB
		--	--	--	✓	3VA9401-0WG30		1	1 unit	1CB
 3VA9221-0WG40	Broadened terminal cover for 4-pole breakers	✓	--	--	--	3VA9111-0WG40		1	1 unit	1CB
		--	✓	--	--	3VA9211-0WG40		1	1 unit	1CB
		--	--	✓	--	3VA9221-0WG40		1	1 unit	1CB
		--	--	--	✓	3VA9401-0WG40		1	1 unit	1CB
Insulating plates specially for fixed mounting										
 3VA9111-0WJ20	Insulating plate, 2-pole	✓	--	--	--	3VA9111-0WJ20		1	1 unit	1CB
 3VA9221-0WJ30	Insulating plate, 3-pole	✓	--	--	--	3VA9111-0WJ30		1	1 unit	1CB
		--	✓	--	--	3VA9211-0WJ30		1	1 unit	1CB
		--	--	✓	--	3VA9221-0WJ30		1	1 unit	1CB
		--	--	--	✓	3VA9481-0WJ30		1	1 unit	1CB
 3VA9221-0WJ40	Insulating plate, 4-pole	✓	--	--	--	3VA9111-0WJ40		1	1 unit	1CB
		--	✓	--	--	3VA9211-0WJ40		1	1 unit	1CB
		--	--	✓	--	3VA9221-0WJ40		1	1 unit	1CB
		--	--	--	✓	3VA9481-0WJ40		1	1 unit	1CB

Molded Case Circuit Breakers

3VA Molded Case Circuit Breakers – Accessories, IEC **NEW**

Connection parts – specially for fixed mounting

2





Version	For molded case circuit breakers/frame size				DT	Article No. www.siemens.com/product?Article No.	Price per PU	PU (UNIT, SET, M)	PS*/P. unit	PG
	3VA1 100 A 160 A	3VA1 250 A	3VA2 100 A 160 A 250 A	3VA2 400 A 630 A						
 <p>3VA9221-0WK30</p>	Insulating plate broadened, 3-pole									
	✓	--	--	--		3VA9111-0WK30		1	1 unit	1CB
	--	✓	--	--		3VA9211-0WK30		1	1 unit	1CB
	--	--	✓	--		3VA9221-0WK30		1	1 unit	1CB
 <p>3VA9221-0WK40</p>	Insulating plate broadened, 4-pole									
	✓	--	--	--		3VA9111-0WK40		1	1 unit	1CB
	--	✓	--	--		3VA9211-0WK40		1	1 unit	1CB
	--	--	✓	--		3VA9221-0WK40		1	1 unit	1CB
 <p>3VA9221-0WK40</p>	Auxiliary conductor terminals specially for fixed mounting									
	Auxiliary conductor terminal for box terminal									
	✓	--	--	--		3VA9110-0WB00		1	10 unit	1CB
	--	✓	✓	--		3VA9200-0WB00		1	10 unit	1CB
 <p>3VA9200-0WB00</p>	Auxiliary conductor terminal for busbar									
	✓	--	--	--		3VA9110-0WC00		1	10 unit	1CB
	--	✓	✓	--		3VA9200-0WC00		1	10 unit	1CB
	--	--	--	✓		3VA9480-0WC00		1	10 unit	1CB
 <p>3VA9113-0SG10</p>	DC insulating plate for 3VA1									
	Versions									
	• For fixed-mounted molded case circuit breakers									
	- 3-pole				✓	--	--	--		3VA9113-0SG10
- 4-pole				✓	--	--	--		3VA9114-0SG10	1 10 unit 1CB
 <p>3VA9112-0SG20</p>	Side plate specially for fixed mounting									
	Side plate for 3VA1									
	Versions									
	• For fixed-mounted molded case circuit breakers									
- 2-pole				✓	--	--	--		3VA9112-0SG20	1 5 unit 1CB

Molded Case Circuit Breakers

NEW 3VA Molded Case Circuit Breakers – Accessories, IEC

Connection methods – specially for plug-in and draw-out units

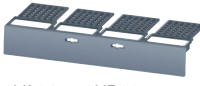
2

Version	For molded case circuit breakers/frame size				DT	Article No. www.siemens.com/product?Article.No.	Price per PU	PU (UNIT, SET, M)	PS*/P. unit	PG
	3VA1 100 A 160 A	3VA1 250 A	3VA2 100 A 160 A 250 A	3VA2 400 A 630 A						
Terminal covers specially for plug-in and draw-out units										
Terminal cover for plug-in/draw-out unit (spare part)										
<ul style="list-style-type: none"> To provide circuit breaker touch protection For mounting on the molded case circuit breaker 										
Versions										
 3VA9113-0KB01	• 3-pole	✓	--	--	--	3VA9113-0KB01		1	1 unit	1CB
		--	✓	--	--	3VA9213-0KB01		1	1 unit	1CB
		--	--	✓	--	3VA9123-0KB01		1	1 unit	1CB
		--	--	--	✓	3VA9353-0KB01		1	1 unit	1CB
 3VA9124-0KB01	• 4-pole	✓	--	--	--	3VA9114-0KB01		1	1 unit	1CB
		--	✓	--	--	3VA9214-0KB01		1	1 unit	1CB
		--	--	✓	--	3VA9124-0KB01		1	1 unit	1CB
		--	--	--	✓	3VA9354-0KB01		1	1 unit	1CB
Terminal cover for plug-in or draw-out socket										
<ul style="list-style-type: none"> For touch protection in the termination area of the plug-in or draw-out socket For mounting on the plug-in or draw-out socket 										
Versions										
 3VA9153-0KB03	• 3-pole	✓	--	--	--	3VA9153-0KB03		1	1 unit	1CB
		--	✓	--	--	3VA9253-0KB03		1	1 unit	1CB
		--	--	✓	--	3VA9163-0KB03		1	1 unit	1CB
		--	--	--	✓	3VA9353-0KB03		1	1 unit	1CB
 3VA9154-0KB03	• 4-pole	✓	--	--	--	3VA9154-0KB03		1	1 unit	1CB
		--	✓	--	--	3VA9254-0KB03		1	1 unit	1CB
		--	--	✓	--	3VA9164-0KB03		1	1 unit	1CB
		--	--	--	✓	3VA9354-0KB03		1	1 unit	1CB
Terminal cover, extended for plug-in or draw-out socket										
<ul style="list-style-type: none"> For touch protection in the termination area of the plug-in or draw-out socket For mounting on the plug-in or draw-out socket 										
Versions										
 3VA9153-0KB04	• 3-pole	✓	--	--	--	3VA9153-0KB04		1	1 unit	1CB
		--	✓	--	--	3VA9253-0KB04		1	1 unit	1CB
		--	--	✓	--	3VA9163-0KB04		1	1 unit	1CB
		--	--	--	✓	3VA9353-0KB04		1	1 unit	1CB
 3VA9154-0KB04	• 4-pole	✓	--	--	--	3VA9154-0KB04		1	1 unit	1CB
		--	✓	--	--	3VA9254-0KB04		1	1 unit	1CB
		--	--	✓	--	3VA9164-0KB04		1	1 unit	1CB
		--	--	--	✓	3VA9354-0KB04		1	1 unit	1CB

Molded Case Circuit Breakers

3VA Molded Case Circuit Breakers – Accessories, IEC **NEW**

Connection methods – specially for plug-in and draw-out units

2

Version	For molded case circuit breakers/frame size				DT	Article No. www.siemens.com/product?Article.No.	Price per PU	PU (UNIT, SET, M)	PS*/P. unit	PG
	3VA1 100 A 160 A	3VA1 250 A	3VA2 100 A 160 A 250 A	3VA2 400 A 630 A						
Terminal cover, broadened, for plug-in or draw-out socket <ul style="list-style-type: none"> For touch protection in the termination area of the plug-in or draw-out socket For mounting on the plug-in or draw-out socket 										
Versions <ul style="list-style-type: none"> 3-pole 										
	✓	--	--	--		3VA9153-0KB05		1	1 unit	1CB
	--	✓	--	--		3VA9253-0KB05		1	1 unit	1CB
	--	--	✓	--		3VA9163-0KB05		1	1 unit	1CB
	--	--	--	✓		3VA9353-0KB05		1	1 unit	1CB
<ul style="list-style-type: none"> 4-pole 										
	✓	--	--	--		3VA9154-0KB05		1	1 unit	1CB
	--	✓	--	--		3VA9254-0KB05		1	1 unit	1CB
	--	--	✓	--		3VA9164-0KB05		1	1 unit	1CB
	--	--	--	✓		3VA9354-0KB05		1	1 unit	1CB



3VA9153-0KB05



3VA9154-0KB05





Version	Minimum mm ² for stranded cable	Maximum mm ² for stranded cable	For molded case circuit breakers/frame size				DT	Article No. www.siemens.com/product?Article.No.	Price per PU	PU (UNIT, SET, M)	PS*/P. unit	PG
			3VA1 160 A	3VA1 250 A	3VA2 100 A 160 A 250 A	3VA2 400 A 630 A						
Circular conductor terminals specially for plug-in and draw-out units												
Circular conductor terminal, large, with auxiliary conductor terminal Included in scope of supply: 3 single terminals and 1 extended terminal cover												
	25 mm ²	150 mm ²	✓	--	--	--		3VA9153-0JC12		1	1 unit	1CB
	50 mm ²	240 mm ²	--	✓	--	--		3VA9253-0JC13		1	1 unit	1CB
	50 mm ²	240 mm ²	--	--	✓	--		3VA9263-0JC13		1	1 unit	1CB
Circular conductor terminal, large, with auxiliary conductor terminal Included in scope of supply: 4 single terminals and 1 extended terminal cover												
	25 mm ²	150 mm ²	✓	--	--	--		3VA9154-0JC12		1	1 unit	1CB
	50 mm ²	240 mm ²	--	✓	--	--		3VA9254-0JC13		1	1 unit	1CB
	50 mm ²	240 mm ²	--	--	✓	--		3VA9264-0JC13		1	1 unit	1CB



3VA9153-0JC12

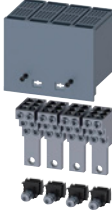

3VA9154-0JC12

	Version	Minimum mm ² for stranded cable	Maximum mm ² for stranded cable	For molded case circuit breakers/frame size				DT	Article No. www.siemens.com/product?Article.No.	Price per PU	PU (UNIT, SET, M)	PS*/P. unit	PG
				3VA1 160 A	3VA1 250 A	3VA2 100 A 160 A 250 A	3VA2 400 A 630 A						
 3VA9263-0JC22	Circular conductor terminal, 2 cables, with auxiliary conductor terminal Included in scope of supply: 3 single terminals and 1 extended terminal cover	2 x 25 mm ²	2 x 150 mm ²	--	✓	--	--	3VA9253-0JC22		1	1 unit	1CB	
		2 x 25 mm ²	2 x 150 mm ²	--	--	✓	--	3VA9263-0JC22		1	1 unit	1CB	
		2 x 70 mm ²	2 x 300 mm ²	--	--	--	✓	3VA9483-0JC23		1	1 unit	1CB	
 3VA9264-0JC22	Circular conductor terminal, 2 cables, with auxiliary conductor terminal Included in scope of supply: 4 single terminals and 1 extended terminal cover	2 x 25 mm ²	2 x 150 mm ²	--	✓	--	--	3VA9254-0JC22		1	1 unit	1CB	
		2 x 25 mm ²	2 x 150 mm ²	--	--	✓	--	3VA9264-0JC22		1	1 unit	1CB	
		2 x 70 mm ²	2 x 300 mm ²	--	--	--	✓	3VA9484-0JC23		1	1 unit	1CB	
 3VA9153-0JF60	Circular conductor terminal, 6 cables Included in scope of supply: 3 single terminals and 1 extended terminal cover	6 x 1.5 mm ²	6 x 35 mm ²	✓	--	--	--	3VA9153-0JF60		1	1 unit	1CB	
		6 x 1.5 mm ²	6 x 35 mm ²	--	✓	--	--	3VA9253-0JF60		1	1 unit	1CB	
		6 x 1.5 mm ²	6 x 35 mm ²	--	--	✓	--	3VA9263-0JF60		1	1 unit	1CB	
		6 x 1.5 mm ²	6 x 35 mm ²	--	--	--	✓	3VA9383-0JF60		1	1 unit	1CB	
 3VA9154-0JF60	Circular conductor terminal, 6 cables Included in scope of supply: 4 single terminals and 1 extended terminal cover	6 x 1.5 mm ²	6 x 35 mm ²	✓	--	--	--	3VA9154-0JF60		1	1 unit	1CB	
		6 x 1.5 mm ²	6 x 35 mm ²	--	✓	--	--	3VA9254-0JF60		1	1 unit	1CB	
		6 x 1.5 mm ²	6 x 35 mm ²	--	--	✓	--	3VA9264-0JF60		1	1 unit	1CB	
		6 x 1.5 mm ²	6 x 35 mm ²	--	--	--	✓	3VA9384-0JF60		1	1 unit	1CB	
Auxiliary conductor terminals specially for plug-in and draw-out units													
 3VA9280-0WB00	Auxiliary conductor terminal for box terminal			✓	--	--	--	3VA9150-0WB00		1	10 unit	1CB	
				--	✓	✓	--	3VA9280-0WB00		1	10 unit	1CB	
				--	--	--	✓	3VA9480-0WB00		1	10 unit	1CB	
 3VA9280-0WC00	Auxiliary conductor terminal for busbar			✓	--	--	--	3VA9150-0WC00		1	10 unit	1CB	
				--	✓	✓	--	3VA9280-0WC00		1	10 unit	1CB	
				--	--	--	✓	3VA9480-0WC00		1	10 unit	1CB	

Molded Case Circuit Breakers

3VA Molded Case Circuit Breakers – Accessories, IEC **NEW**

Plug-in and draw-out technology

Overview

Using plug-in and draw-out technology the 3VA molded case circuit breakers can be installed/removed or replaced quickly and safely. In this case, the cables or busbars of the main current paths are connected to the connectors of the plug-in socket or the draw-out socket.

The termination areas of the sockets for these versions are designed in the same way as those of the molded case circuit breakers but, due to the different requirements for creepages and clearances, have slightly different dimensions.

This means that all connections without insulating measures (e.g. box terminals) from the range of breakers can also be used with the socket for plug-in or draw-out units.

Connections with insulating measures have their own article numbers and are listed below.

A 3VA molded case circuit breaker in the plug-in or draw-out version has plug-in contacts on the input and load side of the main terminals. When the circuit breaker is plugged or moved into the socket, the plug-in contacts slide into the socket-side tulip contacts and connect the main current paths with the circuit breaker. In addition, auxiliary circuit connectors can be used to connect the auxiliary and control signals from the internal accessories of the molded case circuit breaker to the outside.

The main differences between plug-in units and draw-out units are convenience of operation and the potential for functional expansion.

Plug-in technology

Plug-in technology is the less expensive and more space-saving of the two solutions. The plug-in version of the molded case circuit breaker is equipped with plug-in contacts on the back of the 3VA molded case circuit breaker. These make a friction-locked and keyed connection with the corresponding mating connectors in the plug-in socket. The plug-in unit can be supplied as a complete kit or as a conversion kit for breakers including screw-fastened terminal covers.

Installation variants

3VA molded case circuit breakers are available in the following installation variants:

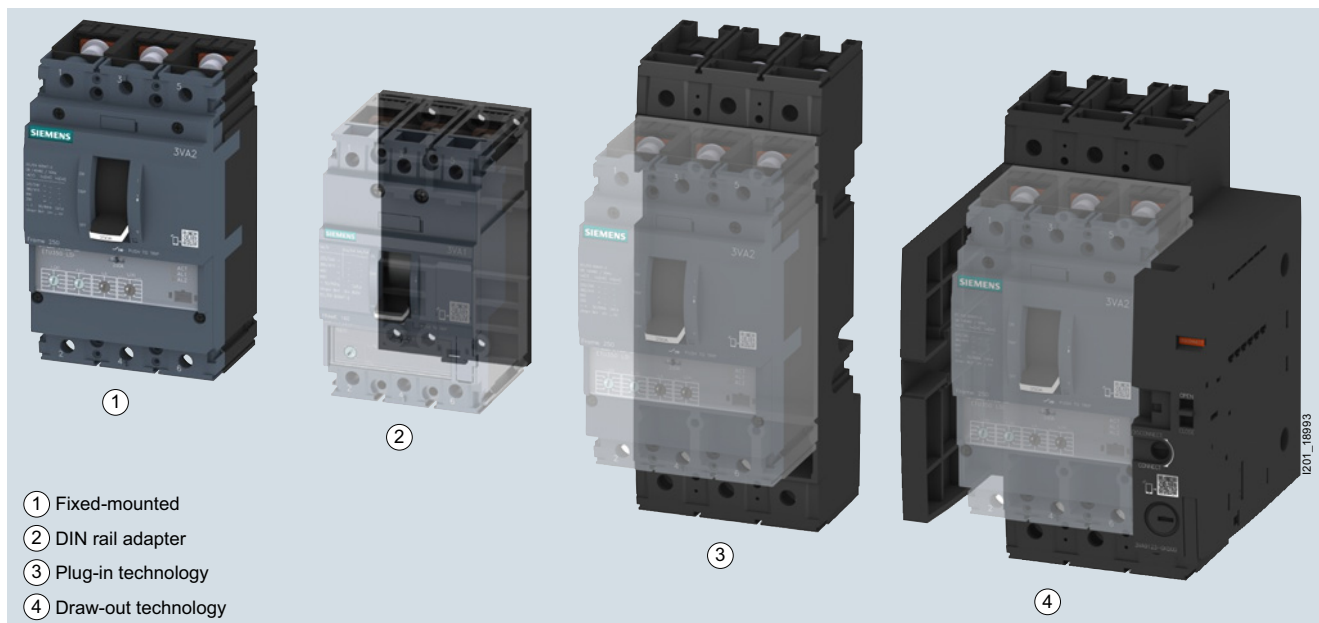

- ① Fixed-mounted
- ② DIN rail adapter
- ③ Plug-in technology
- ④ Draw-out technology

Draw-out technology

Draw-out versions of the molded case circuit breaker are also equipped with plug-in contacts at the main current paths. In addition, side walls including guide and support bolts are bolted to the sides of the molded case circuit breaker. With this version, the mating component is the draw-out socket. It is also equipped with a guide mechanism via which the molded case circuit breaker is moved into the draw-out socket by means of a handle in order to connect the breaker to the main circuits. The operator can clearly read from a position indicator whether the breaker is properly connected to the main circuits or safely isolated from them (so that it can be withdrawn).





Position signaling switches which transmit the position information CONNECT, TEST, and DISCONNECT can be integrated in the right-hand side wall of the draw-out unit. A special set of position signaling switches transfers the position data to the COM060 communication module via a preassembled wires.

The draw-out complete kit as well as the draw-out conversion kit for one breaker are available. Both kits include screw-fastened terminal covers for the breaker. The crank handle for the draw-out unit must be ordered separately.

Benefits

- Molded case circuit breakers can be replaced quickly and easily for the purpose of overhaul or servicing
- Electrical isolation and clearly visible isolating distance
- Socket can be interlocked to prevent the 3VA molded case circuit breaker from being plugged in or moved in
- Identical connection technology for all molded case circuit breakers, whether they are plug-in, draw-out or fixed-mounted units
- Test of the auxiliary and control circuit connections in the test position of the draw-out unit possible without contacted main current paths

Selection and ordering data



Version	For molded case circuit breakers/frame size				DT	Article No. www.siemens.com/product?Article No.	Price per PU	PU (UNIT, SET, M)	PS*/P. unit	PG
	3VA1 160 A	3VA1 250 A	3VA2 100 A, 160 A, 250 A	3VA2 400 A, 630 A						
Plug-in socket										
Plug-in unit, complete kit Comprising: • Plug-in socket • Conversion sets • Mounting screw kit										
Versions										
 3VA9123-0KP00	• 3-pole	✓	--	--	--	3VA9113-0KP00		1	1 unit	1CB
		--	✓	--	--	3VA9213-0KP00		1	1 unit	1CB
		--	--	✓	--	3VA9123-0KP00		1	1 unit	1CB
		--	--	--	✓	3VA9323-0KP00		1	1 unit	1CB
 3VA9124-0KP00	• 4-pole	✓	--	--	--	3VA9114-0KP00		1	1 unit	1CB
		--	✓	--	--	3VA9214-0KP00		1	1 unit	1CB
		--	--	✓	--	3VA9124-0KP00		1	1 unit	1CB
		--	--	--	✓	3VA9324-0KP00		1	1 unit	1CB
Plug-in unit, conversion kit Comprising: • Screw-fastened terminal covers for molded case circuit breakers • Plug-in contacts • Cable cage • Autotrip plunger										
Versions										
 3VA9123-0KP10	• 3-pole	✓	--	--	--	3VA9113-0KP10		1	1 unit	1CB
		--	✓	--	--	3VA9213-0KP10		1	1 unit	1CB
		--	--	✓	--	3VA9123-0KP10		1	1 unit	1CB
		--	--	--	✓	3VA9323-0KP10		1	1 unit	1CB
 3VA9124-0KP10	• 4-pole	✓	--	--	--	3VA9114-0KP10		1	1 unit	1CB
		--	✓	--	--	3VA9214-0KP10		1	1 unit	1CB
		--	--	✓	--	3VA9124-0KP10		1	1 unit	1CB
		--	--	--	✓	3VA9324-0KP10		1	1 unit	1CB



Molded Case Circuit Breakers

3VA Molded Case Circuit Breakers – Accessories, IEC **NEW**

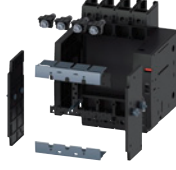
Plug-in and draw-out technology

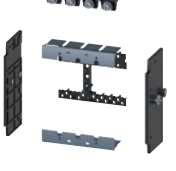
2

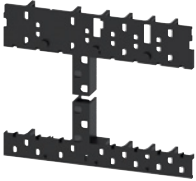
Version	For molded case circuit breakers/frame size				DT	Article No. www.siemens.com/product?ArticleNo	Price per PU	PU (UNIT, SET, M)	PS*/P. unit	PG	
	3VA1 160 A	3VA1 250 A	3VA2 100 A, 160 A, 250 A	3VA2 400 A, 630 A							
Draw-out units											
Draw-out unit, complete kit											
Comprising:											
<ul style="list-style-type: none"> • Draw-out socket • Conversion sets • Mounting screw kit 											
Versions											
 3VA9123-0KD00  3VA9124-0KD00	• 3-pole					3VA9213-0KD00		1	1 unit	1CB	
			✓			3VA9123-0KD00		1	1 unit	1CB	
					✓	3VA9323-0KD00		1	1 unit	1CB	
	• 4-pole					3VA9214-0KD00		1	1 unit	1CB	
			✓			3VA9124-0KD00		1	1 unit	1CB	
					✓	3VA9324-0KD00		1	1 unit	1CB	
	Draw-out unit, conversion kit										
	Conversion kit comprising:										
	<ul style="list-style-type: none"> • Screw-fastened terminal covers for molded case circuit breakers • Side wall • Plug-in contacts • Cable cage • Autotrip plunger 										
Versions											
 3VA9123-0KD10  3VA9124-0KD10	• 3-pole					3VA9213-0KD10		1	1 unit	1CB	
			✓			3VA9123-0KD10		1	1 unit	1CB	
					✓	3VA9323-0KD10		1	1 unit	1CB	
	• 4-pole					3VA9214-0KD10		1	1 unit	1CB	
			✓			3VA9124-0KD10		1	1 unit	1CB	
					✓	3VA9324-0KD10		1	1 unit	1CB	

Version	For molded case circuit breakers/frame size				DT	Article No. www.siemens.com/product?Article No.	Price per PU	PU (UNIT, SET, M)	PS*/P. unit	PG
	3VA1 160 A	3VA1 250 A	3VA2 100 A, 160 A, 250 A	3VA2 400 A, 630 A						
Cable cage										
 <p>Cable cage for plug-in/draw-out unit 3-4-pole (spare part) Cable duct for routing of the required cables from the internal accessories on the back of the circuit breaker</p>	✓	--	--	--		3VA9157-0KB02		1	1 unit	1CB
	--	✓	--	--		3VA9257-0KB02		1	1 unit	1CB
	--	--	✓	--		3VA9167-0KB02		1	1 unit	1CB
	--	--	--	✓		3VA9367-0KB02		1	1 unit	1CB
Door feedthrough										
 <p>Door feedthrough</p>	--	✓	--	--		3VA9257-0KT00		1	1 unit	1CB
	--	--	✓	--		3VA9167-0KT00		1	1 unit	1CB
	--	--	--	✓		3VA9367-0KT00		1	1 unit	1CB

3VA9167-0KB02

3VA9167-0KT00

Molded Case Circuit Breakers

3VA Molded Case Circuit Breakers – Accessories, IEC **NEW**

Plug-in and draw-out technology

2

Version	For molded case circuit breakers/frame size				DT	Article No. www.siemens.com/product?Article No.	Price per PU	PU (UNIT, SET, M)	PS*/P. unit	PG
	3VA1 160 A	3VA1 250 A	3VA2 100 A 160 A 250 A	3VA2 400 A 630 A						

Other accessories



3VA9987-0KC00

Communication link for draw-out unit

- Comprising:
- Cable kit with 3 special position signaling switches
 - Connecting cable 3VA9987-0KC10

3VA9987-0KC00

1 1 unit 1CB



3VA9987-0KB00

Position signaling switches

- For draw-out unit
- For plug-in unit

3VA9987-0KB00

1 1 unit 1CB



3VA9987-0KC10

Spare connecting cable

To connect the position signaling switches for communication with the COM060

3VA9987-0KC10

1 1 unit 1CB



3VA9987-0KD81

Crank handle for draw-out unit

Insulated, incl. crank holder

3VA9987-0KD81

1 1 unit 1CB



3VA9987-0KD80

Auxiliary circuit connector

Versions

- For all draw-out units
- For all plug-in units

Note

All auxiliary circuit connectors are designed to connect 4 cables.

3VA9987-0KD80



1 1 unit 1CB

3VA9987-0KP80

1 1 unit 1CB

3VA9987-0KD80

1 1 unit 1CB

Version	DT	Article No. www.siemens.com/product?Article No.	Price per PU	PU (UNIT, SET, M)	PS*/P. unit	PG
 3VA9980-0VL10		Cylinder lock (type Ronis)				
		<ul style="list-style-type: none"> • Includes a lock with 2 keys • For locking • For installation in all rotary operators with shaft stub • For mounting in the adapter kit for the accessories compartment 				
	Key 1	3VA9980-0VL10		1	1 unit	1CB
	Key 2	3VA9980-0VL20		1	1 unit	1CB
	Key 3	3VA9980-0VL30		1	1 unit	1CB
Key 4	3VA9980-0VL40		1	1 unit	1CB	
 3VA9980-0LF40		Cylinder lock adapter for draw-out unit				
		<ul style="list-style-type: none"> • For fitting a cylinder lock in the right-hand side wall of the draw-out unit • To prevent unauthorized withdrawal or insertion of the circuit breaker into the draw-out unit • Circuit breaker can be locked in the CONNECT, TEST and DISCONNECT positions 				
		3VA9980-0LF40		1	1 unit	1CB

Overview

Residual current devices can be used to prevent or reduce hazardous residual currents that could cause injury to personnel and livestock, and damage to property. These are available as accessory components for the 3VA series up to the largest circuit breaker size. All residual current devices detect both purely sinusoidal AC residual currents as well as pulsating DC residual currents (type A), and the combination of molded case circuit breakers or switch disconnectors with mounted residual current devices complies with IEC 60947-2 Annex B, while the combination with modular residual current devices complies with IEC 60947-2 Annex M.

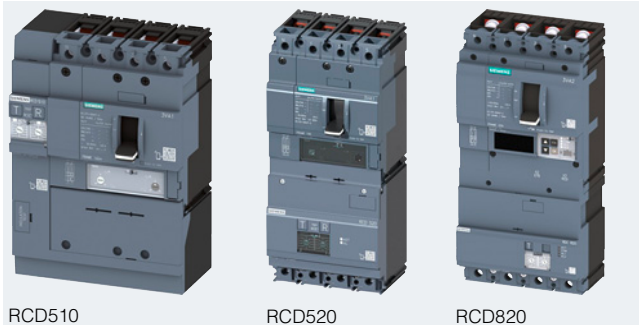

The modular solution consists of a residual current protection device, a separate summation current transformer and a trip element. If the trip element is omitted, the combination of residual current device and summation current transformer works purely as a display unit.

For further information, see chapter "Monitoring Devices" in the section on residual current protection devices (MRCD).

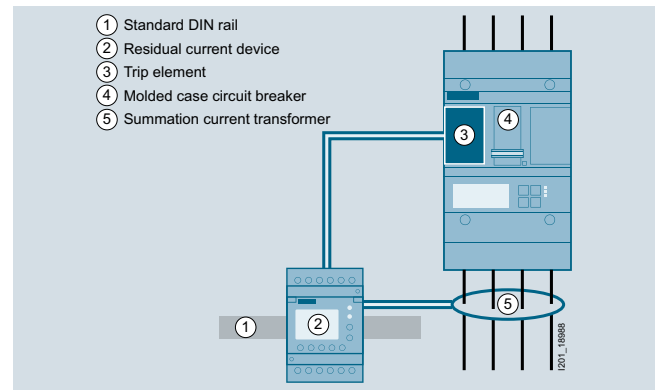

Modular residual current device

Residual current devices "Basic" type for 3VA1

The "Basic" type residual current devices are characterized by the following features:

- LEDs for signaling "ready" state and pre-alarms
- Tripped signal at device and via electrical contacts

On the residual current devices of the 5-series (RCD5..), tripping can be delayed by up to three seconds so that in the event of a fault, only the branch containing the fault is switched off by means of appropriate selective grading of the series-switched residual current devices. The device types of the 3-series (RCD3..) are instantaneous versions, in other words, they trip immediately.

RCD310 and RCD510

The RCD310/RCD510 can be combined with the 3VA1 molded case circuit breaker and the switch disconnector. They are mounted on the left side of the breaker. In the event of a residual current, the breaker is tripped by an RCR (residual current release) built into the left accessories compartment of the breaker.

RCD320 and RCD520

The RCD320 or RCD520 can be installed below the trip unit of the 3VA1 molded case circuit breaker. Equipping the molded case circuit breaker fully with internal accessories is easy because with these residual current devices, the molded case circuit breaker is tripped by a tappet that is already integrated into the residual current device and the circuit breaker.

Residual current devices "Advanced" type for 3VA2

RCD820

"Advanced" residual current devices can detect fault type A currents up to 10 A and type AC up to 30 A. Status message can be forwarded via the large number of auxiliary contacts on the unit or via the communication connection. LEDs for signaling the "ready" state of the residual current device, the communication connection, and the two pre-alarms on the residual current device provide information on the current status on-site.

Modular residual current device for 3VA1/3VA2

As well as a residual current device mounted direct on the breaker, an external solution is also available.

Benefits

RCD310 and RCD510

- Increased packaging density in the cubicle thanks to the compact L-shaped design
- Through-hole technology saves inconvenient wiring of the breaker and the residual current device
- Mounting of a DIN rail adapter enables attachment to a DIN rail
- Side-by-side arrangement with miniature circuit breakers possible thanks to 45 mm cover size
- Function of a shunt trip automatically integrated by RCR dual functionality
- Deliberate acknowledgment of a residual current prevents unintentional restart
- Can be used purely as a display unit

RCD320 and RCD520

- Compact design saves space in the cubicle
- Deliberate acknowledgment of a residual current prevents unintentional restart

RCD820

- Communication connection or alternatively electrical contacts ensure fast status messages – even remotely
- Advanced RCD820 is also suitable for use as a display unit
- Staggered pre-alarms prevent/avoid plant downtimes
- Local presence not required thanks to remote test, acknowledgment and commissioning of the RCD820 via electrical contacts or communication

Modular residual current device







- Modular design allows mounting on different breaker designs (e.g. 1, 2, 3 and 4-pole breakers)
- Reuse in the event of a change of application ensures cost savings
- Time savings thanks to simple upgrading of the residual current functionality in an existing plant
- Especially suitable for use where installation space is restricted



Molded Case Circuit Breakers

3VA Molded Case Circuit Breakers – Accessories, IEC **NEW**

Residual current devices

Selection and ordering data

Version	For molded case circuit breakers/ frame size	DT	Article No. www.siemens.com/product?Article No.	Price per PU	PU (UNIT, SET, M)	PS*/ P. unit	PG
	3VA1 160 A	3VA1 250 A					
Side mounted residual current devices RCD for 3VA1							
<p>Type A (pulse current sensitive)</p> <ul style="list-style-type: none"> Mounted on the side (left) Trip element (RCR) included in the scope of delivery Can be mounted on molded case circuit breakers and switch disconnectors with box terminal $U_e = 127 - 480 \text{ V AC}, 50/60 \text{ Hz}$ <p>Note</p> <p>If the molded case circuit breaker has no box terminals as connections, a set of box terminals must be ordered additionally.</p>							
	RCD310	✓	3VA9114-0RS10		1	1 unit	1CB
3VA9114-0RS10	<ul style="list-style-type: none"> 4-pole Rated residual response current, adjustable: $I_{\Delta n} = 0.03 - 0.05 - 0.1 - 0.3 - 0.5 - 1 - 3 - 5 \text{ A}$; default: 30 mA Instantaneous (INS) 	--					
	RCD510						
3VA9113-0RS20	<ul style="list-style-type: none"> Rated residual response current, adjustable: $I_{\Delta n} = 0.03 - 0.05 - 0.1 - 0.3 - 0.5 - 1 - 3 - 5 \text{ A}$; default: 30 mA Delay time, adjustable: $\Delta t = \text{instantaneous (INS)} - 0.06 - 0.15 - 0.3 - 0.5 - 1 - 2 - 3 \text{ s}$; default: instantaneous (INS) 						
	Versions						
	• 3-pole	✓	3VA9113-0RS20		1	1 unit	1CB
		--	3VA9213-0RS20		1	1 unit	1CB
	• 4-pole	✓	3VA9114-0RS20		1	1 unit	1CB
		--	3VA9214-0RS20		1	1 unit	1CB
	Type A (pulse current sensitive)						
3VA9114-0RS20	<ul style="list-style-type: none"> Mounted below (under trip unit) Can be mounted on molded case circuit breakers $U_e = 127 - 480 \text{ V AC}, 50/60 \text{ Hz}$ 						
	RCD320	✓	3VA9114-0RL10		1	1 unit	1CB
3VA9114-0RL10	<ul style="list-style-type: none"> 4-pole Rated residual response current, adjustable: $I_{\Delta n} = 0.03 - 0.05 - 0.1 - 0.3 - 0.5 - 1 - 3 - 5 \text{ A}$; default: 30 mA Instantaneous (INS) 	--					
	RCD520						
3VA9113-0RL20	<ul style="list-style-type: none"> Rated residual response current, adjustable: $I_{\Delta n} = 0.03 - 0.05 - 0.1 - 0.3 - 0.5 - 1 - 3 - 5 \text{ A}$; default: 30 mA Delay time, adjustable: $\Delta t = \text{instantaneous (INS)} - 0.06 - 0.15 - 0.3 - 0.5 - 1 - 2 - 3 \text{ s}$; default: instantaneous (INS) 						
	Versions						
	• 3-pole	✓	3VA9113-0RL20		1	1 unit	1CB
		--	3VA9213-0RL20		1	1 unit	1CB
	• 4-pole	✓	3VA9114-0RL20		1	1 unit	1CB
		--	3VA9214-0RL20		1	1 unit	1CB
							
3VA9114-0RL20							

Version	For molded case circuit breakers/frame size				DT	Article No. www.siemens.com/product?Article No.	Price per PU	PU (UNIT, SET, M)	PS*/P. unit	PG
	3VA2 100 A 160 A	3VA2 250 A	3VA2 400 A	3VA2 630 A						
Residual current devices RCD for 3VA2										
<p>Type A (pulse current sensitive)</p> <ul style="list-style-type: none"> Mounted below (under trip unit) With energy infeed from below, the required auxiliary switch (AUX) must be ordered separately. $U_e = 127 - 690 \text{ V AC}, 50/60 \text{ Hz}$ 										
<p>RCD820</p> <ul style="list-style-type: none"> Rated residual response current, adjustable: $I_{\Delta n} = 0.03 - 0.05 - 0.1 - 0.3 - 0.5 - 1 - 3 - 5 - 10 - 30 \text{ A}$; default: 30 mA Delay time, adjustable: $\Delta t = 0 - 0.06 - 0.15 - 0.3 - 0.5 - 1 - 2 - 3 - 5 - 10 \text{ s}$; default: instantaneous (INS) Note: 30 A setting range only for type AC applications 										
<p>Versions</p>										
 3VA9123-0RL30  3VA9124-0RL30	• 3-pole	✓	--	--	--	3VA9123-0RL30		1	1 unit	1CB
		--	✓	--	--	3VA9223-0RL30		1	1 unit	1CB
		--	--	✓	--	3VA9323-0RL30		1	1 unit	1CB
		--	--	--	✓	3VA9423-0RL30		1	1 unit	1CB
	• 4-pole	✓	--	--	--	3VA9124-0RL30		1	1 unit	1CB
		--	✓	--	--	3VA9224-0RL30		1	1 unit	1CB
		--	--	✓	--	3VA9324-0RL30		1	1 unit	1CB
		--	--	--	✓	3VA9424-0RL30		1	1 unit	1CB

Molded Case Circuit Breakers

3VA Molded Case Circuit Breakers – Accessories, IEC **NEW**

Communication and testing/commissioning devices

Overview

Metering function

The Rogowski coils integrated in the 3VA2 molded case circuit breakers are capable of delivering particularly accurate current measurements. An additional voltage tap is integrated in molded case circuit breakers equipped with an 8-series ETU, which means that energy data can also be measured – the 3VA2 molded case circuit breaker therefore offers a range of metering functions similar to those available with the tried-and-tested 7KM PAC measuring device!

An external current transformer for N conductors is available to allow direct measurement of the neutral conductor current with 3-pole molded case circuit breakers. When the 3-pole circuit breaker is installed in the 4-pole network, it is advisable to deploy the voltage tap at the neutral conductor so that the neutral point of the voltage network can be fixed.

Communication via the COM800/COM100 breaker data server

The 3VA2 molded case circuit breaker utilizes an innovative, modern communication concept. This concept is based on the COM800 breaker data server which can link up to eight molded case circuit breakers to different bus systems. For applications involving only one 3VA2 molded case circuit breaker, the COM100 is an ideal alternative to the COM800 breaker data server.

The COM060 communication module in the molded case circuit breaker is wired via a T-Connector to the COM800/COM100 breaker data server. Integrated as standard in the COM800/COM100 breaker data server is an Ethernet interface with the Modbus TCP protocol to allow communication with powerconfig and the powermanager. Optional communication modules can be installed to provide different communication protocols. An additional benefit of this structure is that the communication costs per molded case circuit breaker decrease with every further circuit breaker that is connected to the COM800 breaker data server.

The communication equipment for the molded case circuit breakers can be installed and connected extremely easily, reliably and efficiently thanks to the connector system used. The 24 V DC supply to the electronic trip units is also reliably provided by these connections. The breaker data server utilizes independent supplementary functions to deliver valuable information about the connected molded case circuit breakers and the power distribution system.

Flexible communication thanks to optional expansion modules

With COM800/COM100, the 3VA2 molded case circuit breakers can be integrated into the relevant communication networks via the following optional expansion modules:

- Switched Ethernet PROFINET IO
- PROFIBUS DPV1
- RS 485 / Modbus RTU

GSDML or GSD files are also available for PROFINET and PROFIBUS for integration into the engineering system, e.g. STEP 7.

DSP800 display

The DSP800 display can be used to show breaker information (status, measured values, parameters) on the cubicle door. It communicates via the integral Ethernet interface with the COM800/COM100 and is thus able to display the data of up to 8 3VA2 molded case circuit breakers simultaneously.

EFB300 external function box

The EFB300 external function box is linked directly to the ETU of the 3VA2 molded case circuit breaker by a cable. It provides four digital outputs and one digital input. The powerconfig software can be used to set which information is to be output from the ETU via the four digital outputs:

- All reasons for tripping, categorized according to LSING
- Overload alarms AL1 and AL2
- Pre-trip alarm from overload protection system
- Load shedding and load pick-up
- Temperature alarm
- Output of an energy pulse (S0 signal), in combination with an 8-series ETU only

A zone selective interlocking functionality (ZSI) can also be implemented via the module.

Note:

A TD500 or the COM060 and COM800/COM100 combination is needed to program a change in the output assignments with powerconfig.

TD300 and TD500 test devices

The TD300 activation and trip box is a mobile, battery-operated local test device. One of its functions is to provide a temporary power supply to the Electronic Trip Units (ETUs) so that they can be operated and parameterized. It is also used to test the tripping function of the molded case circuit breaker.

The TD500 mobile test device allows the proper functioning and connections of all connected system components to be tested at the breaker commissioning stage because it is capable of simulating every conceivable cause of breaker tripping. The molded case circuit breaker responds as if the emergency were real – it trips in accordance with the set parameters and transmits all alarm and trip signals to the connected components.

The TD500 test device can be used as a hand-held tester or in conjunction with a PC. In the latter case, the TD500 test device is connected to the PC via a supplied USB cable and acts as a gateway to the 3VA2 molded case circuit breaker. Using the powerconfig software, it is possible to read out or modify the setting parameters of the molded case circuit breaker and monitor the measured values.

Benefits

- The metering function integrated in 8-series ETUs can acquire energy data without requiring additional external transformers
- The COM800 breaker data server provides a cost-efficient communication interface for up to 8 3VA2 molded case circuit breakers
- Universal bus interfaces are available for the COM800/COM100 breaker data server
- Universal S0 interface for the output of energy pulses
- 100 test results can be stored with the TD500 test device
- Status and measured values of up to 8 molded case circuit breakers are displayed in the cubicle door using the DSP800

Design

2

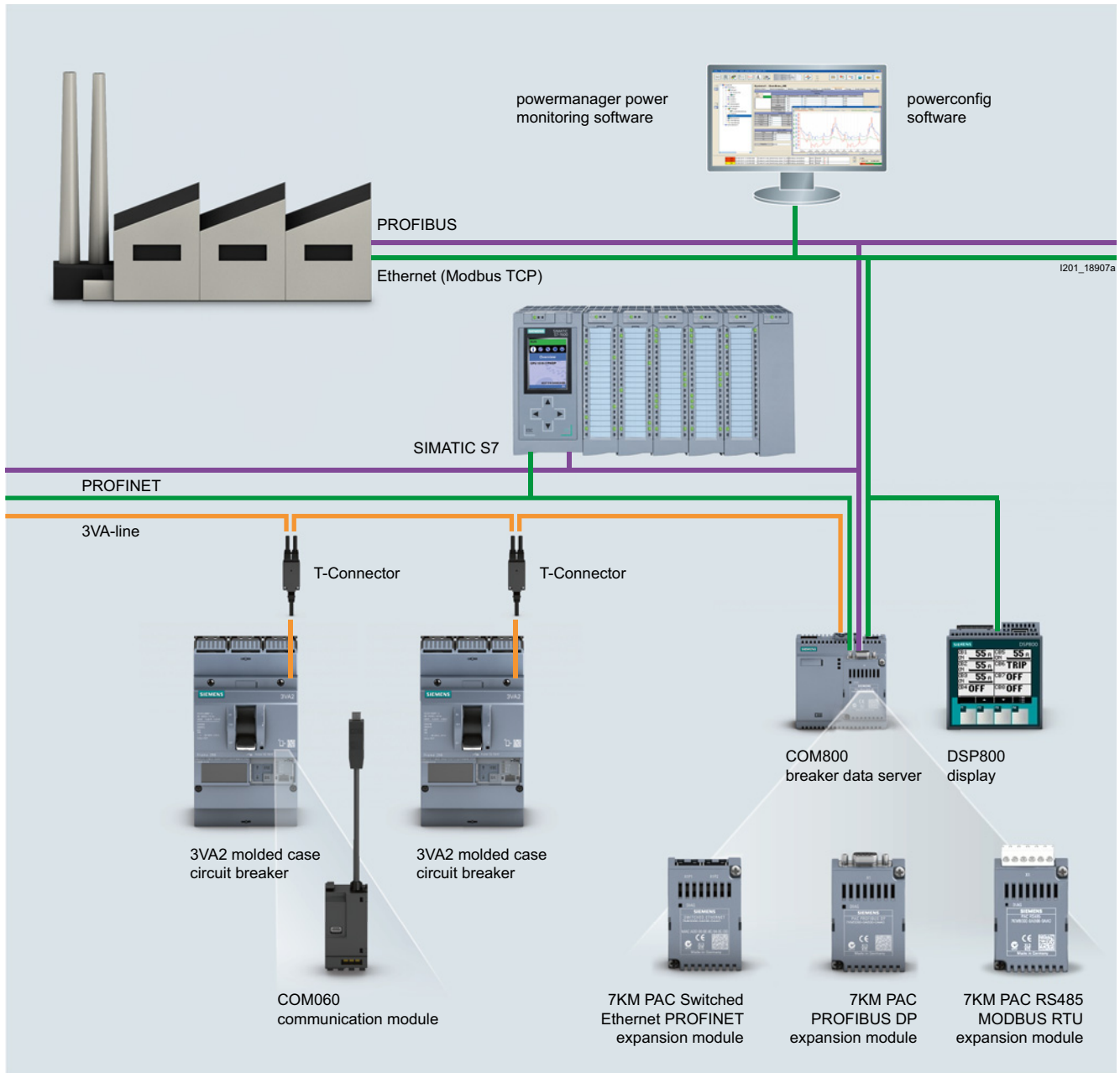

Molded Case Circuit Breakers

3VA Molded Case Circuit Breakers – Accessories, IEC **NEW**

Communication and testing/commissioning devices

Overview of the metering functions

Metering function ¹⁾	ETUs of the		Display		Communication	
	5-series	8-series	In ETU	DSP800		COM800 / COM100
Current						
Phase and neutral conductor currents	I_1, I_2, I_3, I_N	A	✓	✓	👁️	👁️
Residual current to ground	I_g	A	✓	✓	👁️	👁️
Phase with highest load		A	✓	✓	👁️	👁️
Mean value over the three phase currents	$I_{LAVG} = (I_1 + I_2 + I_3) / 3$	A	--	✓	--	👁️
Asymmetry of the phase currents	I_{nba}	%	--	✓	--	👁️
THD of the 3 phases	$THDI_1, THDI_2, THDI_3$	%	--	✓	--	👁️
Voltage						
Phase voltages incl. mean value	$U_{12}, U_{23}, U_{31}, U_{phavg}$	V	--	✓	👁️	👁️
Voltages to N conductor incl. mean value	$U_{1N}, U_{2N}, U_{3N}, U_{Navg}$	V	--	✓	--	👁️
Asymmetry of the voltages		%	--	✓	--	👁️
THD phase/phase and phase/N	$THDI_1, THDI_2, THDI_3$	%	--	✓	--	👁️
Rating						
Active power, total and per phase	P_1, P_2, P_3, P_{tot}	kW	--	✓	👁️ (P_{tot})	👁️
Apparent power, total and per phase	S_1, S_2, S_3, S_{tot}	kVA	--	✓	--	👁️
Reactive power, total and per phase	Q_1, Q_2, Q_3, Q_{tot}	kVAR	--	✓	👁️	👁️
Fundamental power factor	$PF_1, PF_2, PF_3, PF_{avg}$		--	✓	👁️ (PF_{avg})	👁️
Energy						
Active energy, infeed and feedback	E_p	kWh	--	✓	👁️	👁️
Reactive energy, infeed and feedback	E_q	kVARh	--	✓	--	👁️
Apparent energy	E_s	kVAh	--	✓	--	👁️
Frequency						
Present frequency	f	Hz	--	✓	👁️	👁️
Maximum pointer function						
Min/max current, voltage, power	with time stamp		--	--	--	👁️

¹⁾ Depending on ETU version

✓ Available

-- Not available



👁️ Displayable

Accuracy specifications

Accuracy levels of the specified measured values of the 8-series ETU, including the integrated current sensors:

Measured value	Accuracy
Current	1 % in the range from 0.2 ... 1.2 I_n
Voltage	1 % in the range from 80 ... 800 V
Active power, active energy	Class 2 acc. to IEC 61557-12

Selection and ordering data

Version	For molded case circuit breakers/ frame size	DT	Article No. www.siemens.com/product?Article No.	Price per PU	PU (UNIT, SET, M)	PS*/ P. unit	PG
	3VA2 100 A, 160 A, 250 A	3VA2 400 A, 630 A					
24 V module							
 3VA9187-0TB50	24 V module • 24 V DC • For mounting in the right accessories compartment of the 3VA2 • Optional energy supply for the ETU, also includes continuous operation of the ETU display and the metering function of the ETU 8-series		✓	3VA9187-0TB50	1	1 unit	1CB
			--	3VA9387-0TB50	1	1 unit	1CB
Communication accessories in the molded case circuit breaker							
 3VA9187-0TB10	COM060 communication module • For mounting in the right-hand accessories compartment of the 3VA2 molded case circuit breaker (including ETU power supply) • Communication with the COM800/COM100 breaker data server via the 3VA-line • Including a T-Connector		✓	3VA9187-0TB10	1	1 unit	1CB
			--	3VA9387-0TB10	1	1 unit	1CB
Breaker data server							
 3VA9987-0TA10	COM800 breaker data server • 2 terminating resistors • Central communication module for connecting up to eight 3VA2 molded case circuit breakers via the 3VA-line • Ethernet 10/100 Mbit/s interface • Module slot for plugging on an optional PROFIBUS DP or PROFINET module			3VA9987-0TA10	1	1 unit	1CB
 3VA9987-0TA20	COM100 breaker data server • 2 terminating resistors • Optimized, central communication module for connecting a 3VA2 molded case circuit breaker via the 3VA-line • Ethernet 10/100 Mbit/s interface • Module slot for plugging on an optional PROFIBUS DP or PROFINET module			3VA9987-0TA20	1	1 unit	1CB
 7KM9300-0AB01-0AA0	7KM PAC PROFIBUS DP expansion module • The 7KM PAC PROFIBUS DP expansion module is used for connecting the COM800/COM100 breaker data server, and the 3VA molded case circuit breakers connected to it, to PROFIBUS DPV1. • The 7KM PAC PROFIBUS DP expansion module provides the status and measured quantities of the 3VA molded case circuit breaker for the PROFIBUS DP master. It receives information (e.g. commands) from the PROFIBUS DP master, and forwards this information to the 3VA molded case circuit breaker.			7KM9300-0AB01-0AA0	1	1 unit	1DD
 7KM9300-0AE01-0AA0	7KM PAC Switched Ethernet PROFINET expansion module • The 7KM PAC Switched Ethernet PROFINET expansion module is used to connect the COM800/COM100 breaker data server, and the connected 3VA molded case circuit breaker, to PROFINET via two Ethernet interfaces. • The 7KM PAC Switched Ethernet PROFINET expansion module provides the status and measured quantities of the 3VA molded case circuit breaker to PROFINET via the PROFINET IO, PROFinenergy and Modbus TCP protocols.			7KM9300-0AE01-0AA0	1	1 unit	1DD
 7KM9300-0AM00-0AA0	7KM PAC RS485 Modbus RTU expansion module • The 7KM PAC RS485 Modbus expansion module is used to connect the COM800/COM100 breaker data server, and the 3VA molded case circuit breakers connected to it, to Modbus RTU. • The 7KM PAC RS485 Modbus expansion module provides the status and measured quantities of the 3VA molded case circuit breaker for the Modbus RTU master. It receives information (e.g. commands) from the Modbus RTU master, and forwards this information to the 3VA molded case circuit breaker.			7KM9300-0AM00-0AA0	1	1 unit	1DD









* You can order this quantity or a multiple thereof.





Molded Case Circuit Breakers

3VA Molded Case Circuit Breakers – Accessories, IEC **NEW**

Communication and testing/commissioning devices

2

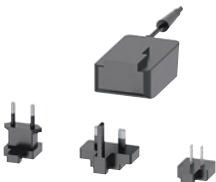
Version	DT	Article No. www.siemens.com/product?Article No.	Price per PU	PU (UNIT, SET, M)	PS*/P. unit	PG	
Accessories for communication							
 3VA9987-OTG10 T-Connector • Spare part • Provides spur line feeder to COM060 and loops through to the next circuit breaker.		3VA9987-OTG10		1	1 unit	1CB	
 3VA9987-OTC10	Preassembled T-Connector-to-T-Connector or T-Connector-to-COM800/COM100 connecting cable			1	1 unit	1CB	
	• 0.4 m long	3VA9987-OTC10		1	1 unit	1CB	
	• 1 m long	3VA9987-OTC20		1	1 unit	1CB	
	• 2 m long	3VA9987-OTC30		1	1 unit	1CB	
 3VA9987-OTF20	Preassembled connecting cable for extending the COM060-to-T-Connector spur line connection			1	1 unit	1CB	
	• 0.4 m long	3VA9987-OTF20		1	1 unit	1CB	
 3VA9987-OTF10	• 0.8 m long	3VA9987-OTF10		1	1 unit	1CB	
 3VA9987-OTE10	Additional bus terminating resistors	3VA9987-OTE10		1	5 units	1CB	
 3VA9987-OUC10	Voltage tap to external N conductor Cable for connecting the neutral point for the metering function of the 8-series ETU, length 1.5 m	3VA9987-OUC10		1	1 unit	1CB	
 3VA9107-ONA10	External current transformer for N conductor Connection of an external current transformer for the N conductor for 3-pole 3VA2 molded case circuit breakers for 5-series and 8-series ETUs, including connecting cable	<ul style="list-style-type: none"> • $I_n = 25 \dots 100$ A • $I_n = 160 \dots 250$ A • $I_n = 400 \dots 630$ A 	3VA9007-ONA10 3VA9107-ONA10 3VA9307-ONA10	1	1 unit	1CB	
	Spare part: cable for connecting external current transformer for N conductor		3VA9907-ONB10	1	1 unit	1CB	
Displays							
 3VA9987-OTD10	DSP800 display • For displaying the status, measured values and parameters of up to 8 3VA2 molded case circuit breakers • Connection to the COM800/COM100 via Ethernet for displaying information of the COM800/COM100 and the connected 3VA2 molded case circuit breaker	3VA9987-OTD10		1	1 unit	1CB	
External function box							
 3VA9987-OUA10	EFB300 • External function box for connection to the ETU of the 3VA2 molded case circuit breaker • 4 digital outputs for information output • 1 digital input • ZSI functionality • SO interface • Including cable 1.5 m in length	3VA9987-OUA10		1	1 unit	1CB	
	Connecting cable for EFB300 Spare part						
	• Length 1.5 m	3VA9987-OUB10		1	1 unit	1CB	
	• Length 3.0 m	3VA9987-OUB20		1	1 unit	1CB	
• Length 3.0 m for 3VA2 with EFB and RCD820	3VA9987-OUB30		1	1 unit	1CB		

Version	DT	Article No. www.siemens.com/ product?Article No.	Price per PU	PU (UNIT, SET, M)	PS*/ P. unit	PG
Test devices						
 3VA9987-0MA10	TD300 <ul style="list-style-type: none"> • Connection to the front interface of the ETU • Test device for activating the ETU and triggering a test trip 	3VA9987-0MA10		1	1 unit	1CB
 3VA9987-0MB10	TD500 <ul style="list-style-type: none"> • Connection to the front interface of the ETU • Initiation of various test trips (LSING) • USB interface for connection of a PC using powerconfig • ETU parameterization • Including an external power supply • Including connecting cable to the 3VA2 molded case circuit breaker 	3VA9987-0MB10		1	1 unit	1CB
 3VA9987-0MX10	Spare part: external power supply for TD500 Spare part 110 ... 240 V AC	3VA9987-0MX10		1	1 unit	1CB
 3VA9987-0MY10	Spare part: cable for connecting the TD500 to the 3VA2 molded case circuit breaker	3VA9987-0MY10		1	1 unit	1CB

Commissioning and service software: powerconfig

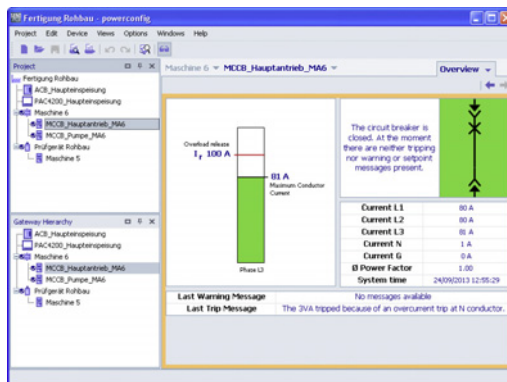

- Commissioning and service software for 3VA2 molded case circuit breakers and further SENTRON components
- For Windows XP, Windows 7 and Windows 8
- Connection via TD500 or COM800/COM100
- Languages: German, English, Chinese, Spanish, Portuguese
- Enables complete use of the electronic components of the 3VA2 such as ETU, EFB300, DSP800, TD500
- Communication via PROFINET, PROFIBUS, Ethernet Modbus TCP and RS 485 with Modbus RTU
- See also chapter "Software" "Configuring, visualizing and controlling with SENTRON".
- powerconfig can be downloaded free of charge from Siemens Industry Online Support at <http://support.automation.siemens.com/WWW/view/en/63452759>
- More information can be found on the Internet at www.siemens.com/sentron.

Molded Case Circuit Breakers

3VA Molded Case Circuit Breakers – Accessories, IEC **NEW**

Locking and interlocking

Overview

With all types of 3VA molded case circuit breakers, a basic distinction is made between:

- Locking of molded case circuit breakers
- Interlocking of molded case circuit breakers

The padlock devices make it possible to lock the 3VA molded case circuit breaker in either the OFF or the ON operating position.

Using the interlocking technology, it is possible to mutually interlock two or more molded case circuit breakers. The interlock system is designed to ensure that no more than one molded case circuit breaker can be operated at a time. The following methods of interlocking can be used on 3VA molded case circuit breakers:

- Front interlock
- Rear interlock

Locking technology

Padlock device for the handle

A padlock device mounted and latched on the handle allows the 3VA molded case circuit breaker to be locked in the OFF or the ON position.

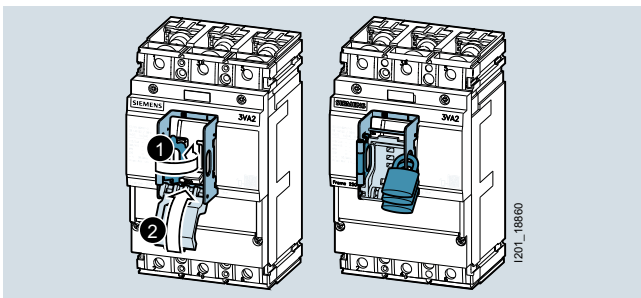

Locking with cylinder lock

The 3VA molded case circuit breaker can also be locked in the OFF (O) or ON (I) position by means of a cylinder lock supplied by Ronis. This prevents further operation of the circuit breaker.

In order to lock a molded case circuit breaker in a specific operating state, the following two components need to be ordered.

- Cylinder lock (type Ronis)
- Lock adapter kit for mounting the cylinder lock in the accessories compartment

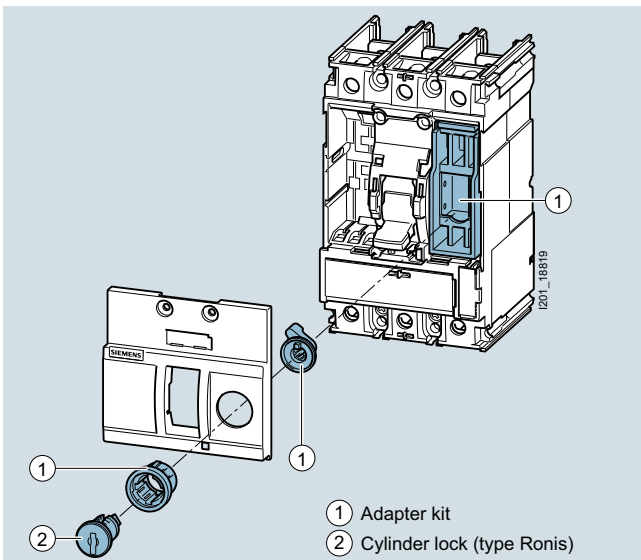

Interlocking technology

Interlocking by means of a sliding bar

The sliding bar allows between two and three 3VA molded case circuit breakers of the same size to be mutually interlocked by means of a sliding bar.

With this device, the sliding bar is moved to block the handle of the interlocked molded case circuit breaker. For this reason, a molded case circuit breaker is always locked in the safe OFF position, while the released circuit breaker can still be operated.

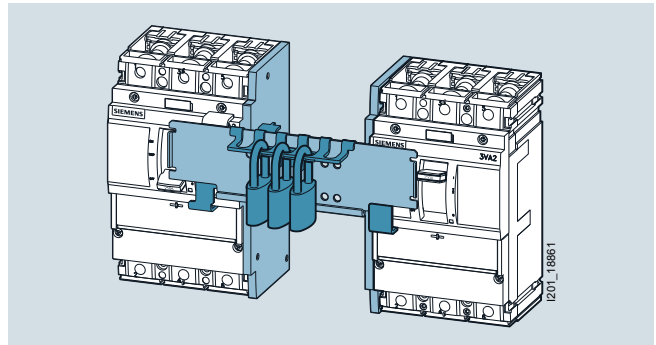

Handle interlock using a Bowden cable

With the front Bowden cable interlock, it is possible to implement a mutual interlock between two or three molded case circuit breakers of different sizes. The front Bowden cable interlock operates according to the blocking principle. In order to implement this system, modules for the Bowden cable interlock must be included in the interlock arrangement. Each of these modules is equipped with a slide which blocks or releases operation of the handle.

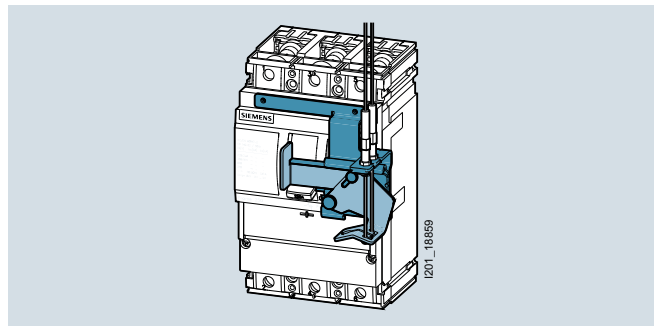

Interlocking with cylinder locks

Using the cylinder lock (type Ronis), it is not only possible to lock a molded case circuit breaker, but also to create an interlock between an optional number of molded case circuit breakers of different sizes. To implement an interlocking application using cylinder locks, the adapter kit with the cylinder lock (type Ronis) must be fitted in the right-hand accessories compartment of each molded case circuit breaker to be included in the interlock arrangement and all breakers must be locked in the OFF position. In order to ensure reliable functioning of the interlock, only one key may be used for the entire interlock application! All other keys must be kept or locked away in a safe place. This one key must be used as the release instrument for only one molded case circuit breaker at a time! To release or operate a molded case circuit breaker, the cylinder lock must be turned to the "Unlocked" position with this one particular key. Only then can the handle of the circuit breaker be moved to the ON position. When the cylinder lock is in the "Unlocked" position, the key cannot be removed and must be left in the lock.

To implement an interlocking application involving multiple molded case circuit breakers, the following two components must be ordered for each circuit breaker:

- Cylinder lock (type Ronis) with identical key number
- Interlock adapter kit for mounting the cylinder lock in the accessories compartment



Interlocking using an interlocking module in the rotary operator

In addition to the interlocking options described above, it is also possible to mutually interlock molded case circuit breakers with rotary operators of different sizes. This type of interlock can be employed with door mounted rotary operators, side wall mounted rotary operators, front operators and rotary operators with shaft stub or combinations thereof.

For this purpose, a rotary operator interlock module must be fitted in each individual rotary operator of the molded case circuit breakers to be included in the interlock arrangement. The interlocking modules are interconnected by means of Bowden cables in a similar manner to the handle interlock.

Rear interlock

The rear interlock system allows implementation of an interlock without restricting the number of accessories which can be installed at the front of the 3VA molded case circuit breaker. Using the rear interlock, it is possible to create an interlock between two molded case circuit breakers of different sizes based on the blocking principle. When one molded case circuit breaker closes, the other circuit breaker is prevented from closing by a tappet which engages in the breaker mechanism directly from the rear panel of the molded case circuit breaker.

This system requires the installation of two interlocking modules which are mounted behind the molded case circuit breakers and behind the mounting frame of the cubicle. The two interlocking modules are interconnected by means of the interlocking rod.

A mounting plate comprising a plate and two DIN rails is available as an accessory to assist installation.

Rear interlock for plug-in or draw-out units

In order to install a rear interlock for plug-in or draw-out versions of the molded case circuit breakers, the tappet needs to be lengthened. The rear interlock for plug-in or draw-out versions is offered as a complete kit.

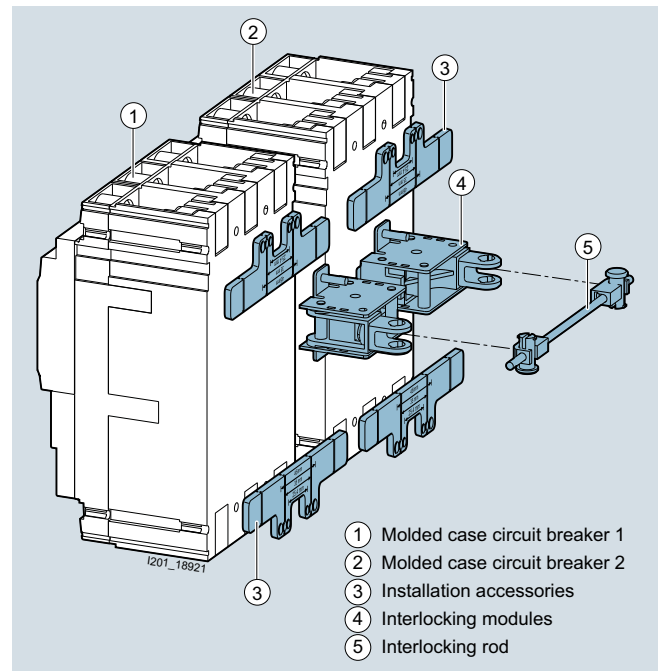

Rear interlock without mounting frame

Benefits

- Broad range of applications thanks to flexibility of interlocking technology
- Locking technology ensures safe locking of molded case circuit breakers, e.g. for maintenance purposes
- No restriction to use of internal accessories or to scope of accessories installed at the front of the molded case circuit breaker (when a rear interlock is deployed)
- Molded case circuit breakers of different sizes can be mutually interlocked.

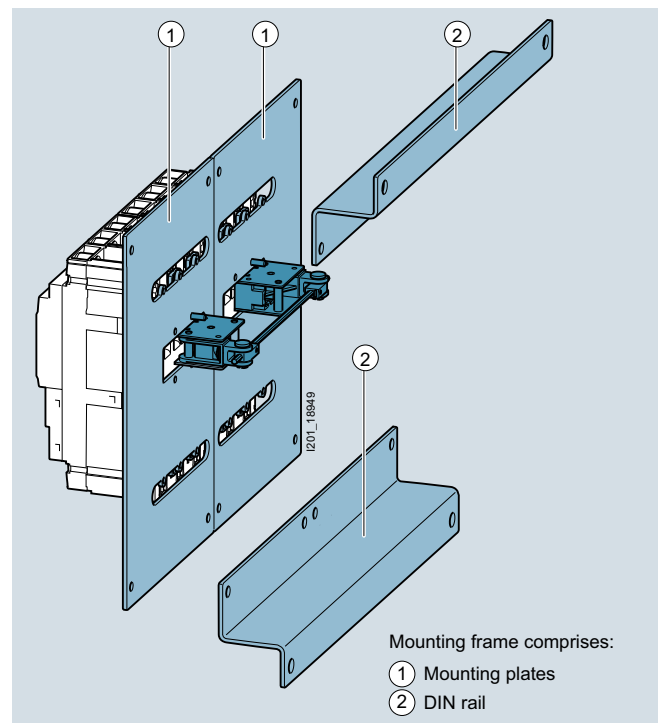

Rear interlock with mounting frame

Molded Case Circuit Breakers

3VA Molded Case Circuit Breakers – Accessories, IEC **NEW**



Locking and interlocking

Selection and ordering data

Version	For molded case circuit breakers/frame size				DT	Article No. www.siemens.com/product?Article No.	Price per PU	PU (UNIT, SET, M)	PS*/P. unit	PG
	3VA1 160 A	3VA1 250 A	3VA2 100 A 160 A 250 A	3VA2 400 A 630 A						

Accessories for locking and interlocking

 3VA9167-0LF10	Adapter kit for mounting the cylinder lock (type Ronis) in the accessories compartment of the molded case circuit breaker Comprising 2 cylinder lock casings (one for locking and one for interlocking) and the appropriate mounting module									
	Notes	✓	--	--	--	3VA9157-0LF10		1	1 unit	1CB
	• To implement an interlock or a lock: select suitable cylinder lock(s)	--	✓	--	--	3VA9257-0LF10		1	1 unit	1CB
	• For an interlock: select the same cylinder lock number	--	--	✓	--	3VA9167-0LF10		1	1 unit	1CB
		--	--	--	✓	3VA9367-0LF10		1	1 unit	1CB
 3VA9980-0VL10	Cylinder lock (type Ronis) • Includes a lock with 2 keys • For locking or interlocking • For installation in all rotary operators with shaft stub • For mounting in the adapter kit for the accessories compartment									
	Versions									
	• Key 1 (lock number 1)	✓	✓	✓	✓	3VA9980-0VL10		1	1 unit	1CB
	• Key 2 (lock number 2)	✓	✓	✓	✓	3VA9980-0VL20		1	1 unit	1CB
	• Key 3 (lock number 3)	✓	✓	✓	✓	3VA9980-0VL30		1	1 unit	1CB
• Key 4 (lock number 4)	✓	✓	✓	✓	3VA9980-0VL40		1	1 unit	1CB	
 3VA9168-0VF30	Sliding bar Complete kit for interlocking 2 circuit breakers									
	Note	✓	--	--	--	3VA9158-0VF30		1	1 unit	1CB
	The article number must be ordered 2 x to implement an interlock between 3 breakers of the same size.	--	✓	--	--	3VA9258-0VF30		1	1 unit	1CB
		--	--	✓	--	3VA9168-0VF30		1	1 unit	1CB
		--	--	--	✓	3VA9368-0VF30		1	1 unit	1CB
 3VA9167-0VF10	Module for handle interlock using a Bowden cable									
	Notes	✓	--	--	--	3VA9157-0VF10		1	1 unit	1CB
	• A separate handle interlock module is required for each 3VA.	--	✓	--	--	3VA9257-0VF10		1	1 unit	1CB
	• A Bowden cable must be ordered separately.	--	--	✓	--	3VA9167-0VF10		1	1 unit	1CB
		--	--	--	✓	3VA9367-0VF10		1	1 unit	1CB
 3VA9088-0VM10	Rear interlock with rod Complete kit	✓	✓	✓	✓	3VA9088-0VM10		1	1 unit	1CB
	Note Mounting frames are not included in scope of supply.									
 3VA9088-0VM30	Rear interlock with rod Complete kit for plug-in/draw-out unit	✓	✓	✓	✓	3VA9088-0VM30		1	1 unit	1CB
	Note Mounting frames are not included in scope of supply.									
	Mounting frame for rear interlock with rod The following are required for the complete mounting frame kit:									
	Versions									
	• DIN rails	✓	✓	✓	✓	3VA9088-0VK10		1	1 unit	1CB
	• Mounting plates	✓	--	--	--	3VA9158-0VK20		1	1 unit	1CB
		--	✓	--	--	3VA9258-0VK20		1	1 unit	1CB
		--	--	✓	--	3VA9268-0VK20		1	1 unit	1CB
	--	--	--	✓	3VA9468-0VK20		1	1 unit	1CB	
Note	2 mounting plates are required. They are screwed onto the DIN rail that can be ordered above. Different breakers can be mutually interlocked.									

Version	For molded case circuit breakers/ frame size				DT	Article No. www.siemens.com/ product?Article No.	Price per PU	PU (UNIT, SET, M)	PS*/ P. unit	PG
	3VA1 100 A 160 A	3VA1 250 A	3VA2 100 A 160 A 250 A	3VA2 400 A 630 A						
Accessories for locking and interlocking										
 3VA9388-OLB10	Locking devices for toggle levers									
	✓	✓	--	--	3VA9088-OLB10			1	1 unit	1CB
	--	--	✓	✓	3VA9388-OLB10			1	1 unit	1CB
Bowden cable										
Versions										
	• Length 0.6 m					3VA9980-OVC10		1	1 unit	1CB
	• Length 1.0 m					3VA9980-OVC20		1	1 unit	1CB
	• Length 1.5 m					3VA9980-OVC30		1	1 unit	1CB
 3VA9980-OVC10										

Molded Case Circuit Breakers

3VA Molded Case Circuit Breakers – Accessories, IEC **NEW**

Other

Selection and ordering data

Version	For molded case circuit breakers/frame size				DT	Article No. www.siemens.com/product?Article No.	Price per PU	PU (UNIT, SET, M)	PS*/P. unit	PG
	3VA1 100 A, 160 A	3VA1 250 A	3VA2 100 A, 160 A, 250 A	3VA2 400 A, 630 A						
Escutcheon for door cutout										
Escutcheon for door cutout for molded case circuit breaker										
Versions										
• 3-pole, door cutout without ETU	✓	--	--	--		3VA9053-0SB10		1	1 unit	1CB
	--	✓	--	--		3VA9253-0SB10		1	1 unit	1CB
	--	--	✓	--		3VA9163-0SB10		1	1 unit	1CB
	--	--	--	✓		3VA9383-0SB10		1	1 unit	1CB
• 3-pole, door cutout with ETU	✓	--	--	--		3VA9053-0SB20		1	1 unit	1CB
	--	✓	--	--		3VA9253-0SB20		1	1 unit	1CB
	--	--	✓	--		3VA9163-0SB20		1	1 unit	1CB
	--	--	--	✓		3VA9363-0SB20		1	1 unit	1CB
• 4-pole, door cutout without ETU	✓	--	--	--		3VA9054-0SB10		1	1 unit	1CB
	--	✓	--	--		3VA9254-0SB10		1	1 unit	1CB
	--	--	✓	--		3VA9164-0SB10		1	1 unit	1CB
	--	--	--	✓		3VA9384-0SB10		1	1 unit	1CB
• 4-pole, door cutout with ETU	✓	--	--	--		3VA9054-0SB20		1	1 unit	1CB
	--	✓	--	--		3VA9254-0SB20		1	1 unit	1CB
	--	--	✓	--		3VA9164-0SB20		1	1 unit	1CB
	--	--	--	✓		3VA9364-0SB20		1	1 unit	1CB
Escutcheon for MO320 motor operators										
✓	--	--	--	--		3VA9053-0SB20		1	1 unit	1CB
--	✓	✓	--	--		3VA9257-0SB30		1	1 unit	1CB
--	--	--	✓	--		3VA9387-0SB30		1	1 unit	1CB
Masking frame for RCD320, RCD520 and RCD820 residual current protection device										
Versions										
• 3-pole	✓	--	--	--		3VA9053-0SB10		1	1 unit	1CB
	--	✓	✓	--		3VA9253-0SB10		1	1 unit	1CB
	--	--	--	✓		3VA9303-0SB40		1	1 unit	1CB
• 4-pole	✓	--	--	--		3VA9054-0SB10		1	1 unit	1CB
	--	✓	✓	--		3VA9254-0SB10		1	1 unit	1CB
	--	--	--	✓		3VA9304-0SB40		1	1 unit	1CB
Escutcheon for front mounted rotary operator										
✓	--	--	--	--		3VA9053-0SB10		1	1 unit	1CB
--	✓	--	--	--		3VA9253-0SB10		1	1 unit	1CB
--	--	✓	--	--		3VA9163-0SB10		1	1 unit	1CB
--	--	--	✓	--		3VA9383-0SB10		1	1 unit	1CB
Escutcheon for door feedthrough										
--	✓	✓	--	--		3VA9253-0SB20		1	1 unit	1CB
--	--	--	✓	--		3VA9353-0SB20		1	1 unit	1CB
Labeling plate for escutcheon										
						3VA9087-0SX10		1	10 units	1CB



3VA9163-0SB10



3VA9087-0SX10

Version	For molded case circuit breakers/frame size				DT	Article No. www.siemens.com/product?Article No.	Price per PU	PU (UNIT, SET, M)	PS*/P. unit	PG
	3VA1 100 A 160 A	3VA1 250 A	3VA2 100 A 160 A 250 A	3VA2 400 A 630 A						

Adapter for DIN rails for 3VA1 molded case circuit breakers



Adapter for DIN rails for 3VA1 molded case circuit breakers

Versions

- 1-pole¹⁾
- 2-pole
- 3- and 4-pole
- 3 and 4-pole in conjunction with RCD310 or RCD510

✓	--	--	--	3VA9181-0SH10	1	1 unit	1CB
✓	--	--	--	3VA9182-0SH10	1	1 unit	1CB
✓	--	--	--	3VA9187-0SH10	1	1 unit	1CB
✓	--	--	--	3VA9187-0SH20	1	1 unit	1CB

3VA9187-0SH10

Adapter for 60 mm busbar system (8US)



Busbar adapter systems with 40 mm or 60 mm busbar center-to-center spacing with components for busbar runs, adapters and switching device holders for individual equipment possibilities, devices with an integrated adapter, as well as accessories and flat copper profiles. Observe the short-circuit strength of the busbar system. Short-circuit strength greater than 50 kA on request.

For more information, see chapter "Busbar Systems".

Mounting screw kit



Mounting screw kit

Versions

- For fixed-mounted molded case circuit breakers
 - 1-pole
 - 2 and 3-pole (apart from 125 A/160 A with 55 kA and 70 kA)
 - 3-pole (125 A/160 A with 55 kA and 70 kA) and 4-pole
 - 3-pole
 - 4-pole
 - 3- and 4-pole
- For plug-in technology
- For plug-in and draw-out units

✓	--	--	--	3VA9111-0SS10	1	1 unit	1CB
✓	✓	--	--	3VA9116-0SS10	1	1 unit	1CB
✓	✓	--	--	3VA9114-0SS10	1	1 unit	1CB
--	--	✓	--	3VA9126-0SS10	1	1 unit	1CB
--	--	✓	--	3VA9124-0SS10	1	1 unit	1CB
--	--	--	✓	3VA9328-0SS10	1	1 unit	1CB
✓	✓	--	--	3VA9114-0SS10	1	1 unit	1CB
--	✓	--	--	3VA9114-0SS10	1	1 unit	1CB
--	--	✓	--	3VA9124-0SS10	1	1 unit	1CB
--	--	--	✓	3VA9328-0SS10	1	1 unit	1CB

3VA9111-0SS10

¹⁾ For 3VA1 molded case circuit breakers, 160 A 1-pole up to 25 kA









Molded Case Circuit Breakers









3VL Molded Case Circuit Breakers up to 1600 A, IEC

Introduction

Overview

2

Devices	Page	Applications/ Individual components	Standards	Used in		
				Non-residential buildings	Residential buildings	Industry
 <p>3VL molded case circuit breakers for line protection</p> <p>3VL molded case circuit breakers for generator protection</p>	2/126 ... 2/141, 2/150 ... 2/167	<p>The overload and short-circuit releases are designed for the protection of cables, leads and non-motor loads.</p> <p>The overload and short-circuit releases can be used for optimized protection of generators.</p>	IEC 60947-1, EN 60947-1, IEC 60947-2, EN 60947-2.	✓	✓	✓
 <p>3VL molded case circuit breakers for motor protection</p> <p>Are you IE3 ready?</p> 	2/142 ... 2/145	<p>Circuit breakers for motor protection are specifically designed for the characteristic curve of the motor, and have additional functions such as phase failure detection and adjustable trip class.</p>	IEC 60947-1, EN 60947-1, IEC 60947-2, EN 60947-2. IE3 ready	✓	✓	✓
 <p>3VL molded case circuit breakers for starter protection</p> <p>Are you IE3 ready?</p> 	2/146, 2/147	<p>Starter combinations consist of: Motor starter protector + contactor + overload relay. The motor starter protector provides short-circuit protection and the isolating function. The task of the contactor is the operational switching of the feeder. The overload relay provides overload protection, which is specifically designed for the motor.</p>	IEC 60947-1, EN 60947-1, IEC 60947-2, EN 60947-2. IE3 ready	✓	✓	✓
 <p>3VL non-automatic circuit breakers, molded case</p>	2/146, 2/147, 2/168, 2/169	<p>These circuit breakers are used as feeder circuit breakers, main control switches or disconnectors without overload protection. They have fixed short-circuit releases.</p>	IEC 60947-1, EN 60947-1, IEC 60947-2, EN 60947-2. Isolating features according to IEC 60947-2 and EN 60947-2.	✓	✓	✓
 <p>Auxiliary switches and auxiliary releases for 3VL molded case circuit breakers</p>	2/175, 2/176	<p>Auxiliary switches, alarm switches, undervoltage releases and shunt releases</p>	As for circuit breakers	✓	✓	✓
 <p>Operating mechanisms</p>	2/178 ... 2/185	<p>The manual operating mechanisms are available in two versions:</p> <ul style="list-style-type: none"> • Front-operated rotary operating mechanism, • Door-coupling rotary operating mechanism <p>In the case of the motorized operating mechanisms there are also two versions:</p> <ul style="list-style-type: none"> • MO for standard applications • SEO for network synchronization tasks 	As for circuit breakers	✓	✓	✓
 <p>Plug-in versions/ withdrawable versions</p>	2/186 ... 2/191	<p>Assembly in plug-in and withdrawable versions allows the 3VL molded case circuit breaker to be replaced quickly without accessing the terminals.</p>	As for circuit breakers	✓	✓	✓

Devices	Page	Applications/ Individual components	Standards	Used in		
				Non-residential buildings	Residential buildings	Industry
	2/192	Protection of plant and personnel against damage or injury caused by residual currents and insulation faults.	IEC EN 60947-2 (Annex B)	✓	✓	✓
	Ch. 12	Modular residual current devices (MRCD) monitor residual currents in electrical systems and trip the molded case circuit breaker via an auxiliary release after an adjustable advance warning if the residual current exceeds a defined value.	IEC EN 60947-2 (Annex M)	✓	✓	✓
	2/193 ... 2/198	Front connecting bars, rear terminals, box terminals, circular conductor terminals, multiple feed-in terminals, auxiliary conductor terminals, terminal plates, connections with screw terminals, terminal covers for circuit breakers, phase barriers for circuit breakers	As for circuit breakers	✓	✓	✓
	2/199 ... 2/204	Locking devices for toggle levers, rear interlocking modules, interlocking modules for Bowden wire interlocking	As for circuit breakers	✓	✓	✓
	Ch. 12	The 3KC ATC5300 and ATC3100 transfer control devices, equipped with two circuit breakers with motorized operating mechanism, serve as a transfer system that automatically or manually switches between two power supply systems in low-voltage power distribution applications.	IEC 60947-6-1 DIN VDE 0660-114 UL 508 CSA 22.2 No. 14	✓	✓	✓
	Ch. 10	Busbar adapters	As for circuit breakers	✓	✓	✓
	2/207	Data transmission through COM20, COM21: COM20 (PROFIBUS) for Electronic Trip Units with communication function, COM21 (MODBUS) for Electronic Trip Units with communication function, powerconfig parameterization software	As for circuit breakers	✓	✓	✓
	2/208 ... 2/211	Masking frames (cover frames) for door cutouts, to increase degree of protection	As for circuit breakers	✓	✓	✓

Molded Case Circuit Breakers

3VL Molded Case Circuit Breakers up to 1600 A, IEC

Introduction

2



Type VL160X/3VL1 VL160/3VL2 VL250/3VL3 VL400/3VL4

Molded case circuit breakers

3VL molded case circuit breakers up to 1600 A

Rated current I_n at 50 °C ambient temperature	A	16 ... 160		50 ... 160		200 ... 250		200 ... 400	
Number of poles		3	4	3	4	3	4	3	4
Rated operational voltage U_e 50/60 Hz AC	V	690	690	690	690	690	690	690	690
DC ¹⁾	V	500	500 ²⁾	600	600	600	600	600	600
Trip Units									
Thermal-magnetic		✓	✓	✓	✓	✓	✓	✓	✓
Electronic LCD ETU/ETU		--	--	✓	✓	✓	✓	✓	✓
PROFIBUS module COM20		--	--	✓	✓	✓	✓	✓	✓
Dimensions									
	A	mm	105	139	105	139	105	139	139
	B	mm	157	157	175	175	175	175	279
	C	mm	81	81	81	81	81	81	102
	D	mm	107	107	107	107	107	107	138

Breaking capacity I_{cu}/I_{cs} RMS value acc. to IEC 60947-2

Standard breaking capacity N ³⁾	(N)				
Up to 240 V AC	kA	65/65	65/65	65/65	65/65
Up to 415 V AC	kA	55/55	55/55	55/55	55/55
Up to 440 V AC	kA	25/20	25/20	25/20	35/26
Up to 500/525 V AC	kA	18/14	25/20	25/20	25/20
Up to 690 V AC	kA	8/4 ⁴⁾	12/6	12/6	15/8
Up to 250 V DC ⁵⁾	kA	30/30	32/32	32/32	32/32
Up to 500 V DC ⁵⁾	kA	--	--	--	--
Up to 600 V DC ⁵⁾	kA	--	--	--	--
NEMA breaking capacity ⁶⁾					
Up to 480 V AC	kA	25	25	25	35
Up to 600 V AC	kA	8 ⁴⁾	12	12	20
High breaking capacity H ³⁾	(H)				
Up to 240 V AC	kA	100/75	100/75	100/75	100/75
Up to 415 V AC	kA	70/70	70/70	70/70	70/70
Up to 440 V AC	kA	42/32	50/38	50/38	50/38
Up to 500/525 V AC	kA	30/23	40/30	40/30	40/30
Up to 690 V AC	kA	12/6 ⁴⁾	12/6	12/6	15/8
Up to 250 V DC ⁵⁾	kA	30/30	32/32	32/32	32/32
Up to 500 V DC ⁵⁾	kA	30/30	32/32	32/32	32/32
Up to 600 V DC ⁵⁾	kA	--	--	--	--
NEMA breaking capacity ⁶⁾					
Up to 480 V AC	kA	42	50	50	50
Up to 600 V AC	kA	12 ⁴⁾	12	12	20
Very high breaking capacity L ³⁾	(L)				
Up to 240 V AC	kA	--	200/150	200/150	200/150
Up to 415 V AC	kA	--	100/75	100/75	100/75
Up to 440 V AC	kA	--	75/50	75/50	75/50
Up to 500/525 V AC	kA	--	50/38	50/38	50/38
Up to 690 V AC	kA	--	12/6	12/6	15/8
Up to 250 V DC ⁵⁾	kA	--	32/32	32/32	32/32
Up to 500 V DC ⁵⁾	kA	--	32/32	32/32	32/32
Up to 600 V DC ⁵⁾	kA	--	32/32	32/32	32/32
NEMA breaking capacity ⁶⁾					
Up to 480 V AC	kA	--	75	75	75
Up to 600 V AC	kA	--	12	12	20

✓ Available
 -- Not available

1) Rated DC voltage applies only for circuit breakers with thermal-magnetic trip unit.

2) For PV applications up to $U_{oc} = 1000$ V DC.

For 3VL molded case circuit breakers according to UL 489, see page 2/214 or see Catalog LV 16.



VL630/3VL5

VL800/3VL6

VL1250/3VL7

VL1600/3VL8

3VL molded case circuit breakers up to 1600 A

315 ... 630		800		1000 ... 1250		1600	
3	4	3	4	3	4	3	4
690 600	690 600	-- --	690 --	690 --	690 --	690 --	690 --
✓ ✓ ✓	✓ ✓ ✓	-- ✓ ✓	-- ✓ ✓	-- ✓ ✓	-- ✓ ✓	-- ✓ ✓	-- ✓ ✓
190 279 102 138	253 279 102 138	190 406 114 151	253 406 114 151	229 406 152 207	305 406 152 207	229 406 152 207	305 406 152 207
65/65 55/55 35/26 25/20 20/10 32/32 -- --		65/65 55/55 35/26 25/20 20/10 -- -- --		65/35 55/28 35/26 25/20 20/10 -- -- --		65/35 55/28 35/26 25/20 20/10 -- -- --	
25 20		25 20		25 20		25 20	
100/75 70/70 50/38 40/30 20/10 32/32 32/32 --		100/75 70/70 50/38 40/30 20/10 -- -- --		100/50 70/35 50/38 40/30 30/15 -- -- --		100/50 70/35 50/38 40/30 30/15 -- -- --	
50 30		50 30		50 30		50 30	
200/150 100/75 75/50 50/38 20/10 32/32 32/32 32/32		200/150 100/75 75/50 50/38 20/10 -- -- --		200/100 100/50 75/50 50/38 35/17 -- -- --		200/100 100/50 75/50 50/38 35/17 -- -- --	
65 35		65 35		65 35		65 35	

3) At 240 V AC, 415 V AC, 525 V AC and 690 V AC max. 5 % overvoltage, at 440 V AC and 500 V AC max. 10 % overvoltage, at 250/500/600 V DC max. 5 % overvoltage.

4) Rated current $I_n \geq 25$ A.

5) The maximum permitted DC voltage for each conducting path needs to be taken into account for DC switching applications; see Technical Information at www.siemens.com/lowvoltage/product-support; time constant $t = 15$ ms.

6) The NEMA breaking capacity can be found on the rating plate of each IEC circuit breaker.

Molded Case Circuit Breakers

3VL Molded Case Circuit Breakers up to 1600 A, IEC

Introduction

2

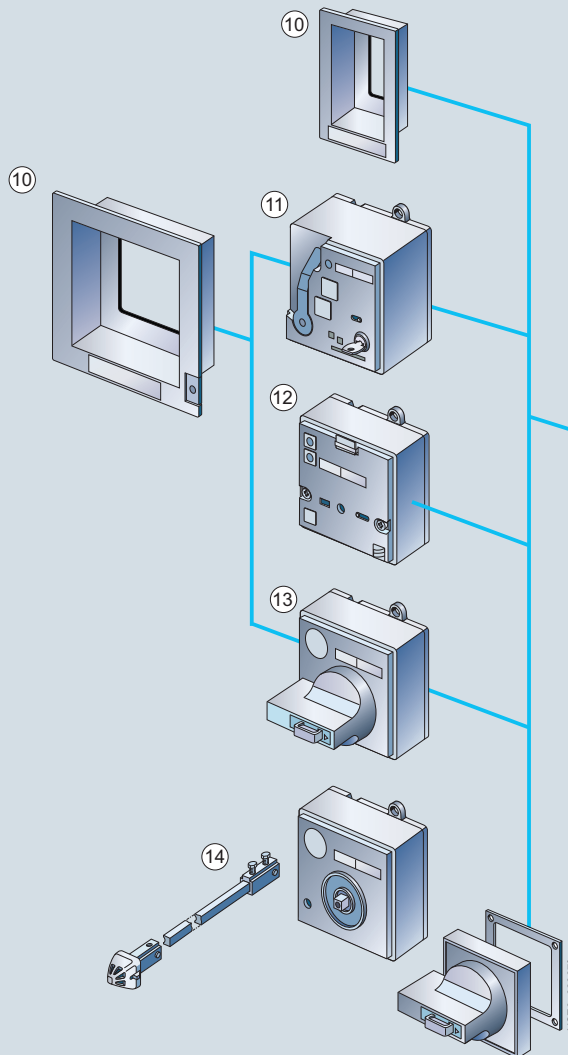

- ① Withdrawable/plug-in bases (pages 2/186 to 2/191)
- ② Side walls of withdrawable unit (pages 2/186 to 2/191)
- ③ Phase barriers (pages 2/193 to 2/198)
- ④ Flared front busbar connecting bars (pages 2/193 to 2/198)
- ⑤ Straight connecting bars (pages 2/193 to 2/198)
- ⑥ Circular conductor terminals for Al/Cu (pages 2/193 to 2/195)
- ⑦ Box terminals for Cu (pages 2/193 to 2/198)
- ⑧ Extended connection covers (terminal covers) (pages 2/193 to 2/198)
- ⑨ Standard connection covers (pages 2/193 to 2/198)
- ⑩ Masking frames/cover frames for door cutout (pages 2/208 to 2/211)
- ⑪ Motorized operating mechanisms with stored energy mechanism (SEO) (page 2/182)
- ⑫ Motorized operating mechanism (MO) (page 2/182)
- ⑬ Front-operated rotary operating mechanisms (pages 2/178 to 2/181)
- ⑭ Door-coupling rotary operating mechanisms (pages 2/178 to 2/181)
- ⑮ 3VL molded case circuit breakers (pages 2/126 to 2/169)
- ⑯ Internal accessories (pages 2/173, 2/174, 2/175 to 2/177)
- ⑰ Electronic Trip Units LCD ETU (pages 2/136, 2/140, 2/144, 2/160 and 2/162)
- ⑱ Electronic Trip Units with communication function (pages 2/128 to 2/144 and 2/156 to 2/166)
- ⑲ Thermal/magnetic overcurrent releases (pages 2/126 to 2/128, 2/146, 2/150 to 2/154, 2/168)
- ⑳ RCD modules (page 2/192)
- ㉑ Rear terminals – flat and round (pages 2/193 to 2/198)
- ㉒ COM20/21 communication modules to the PROFIBUS DP/MODBUS (page 2/207)
- ㉓ Battery power supplies with test function for Electronic Trip Units (pages 2/200 to 2/204)

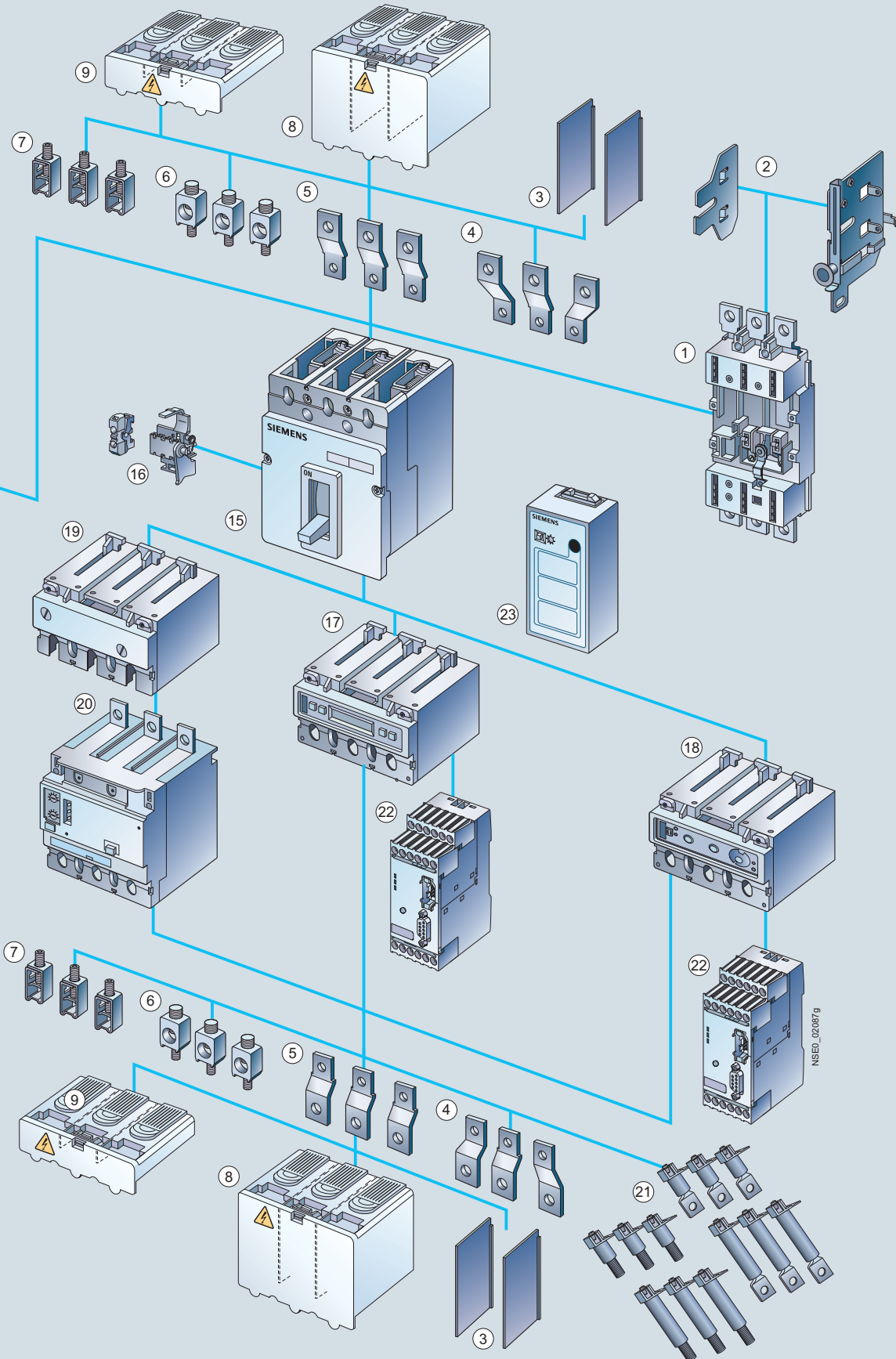

Molded Case Circuit Breakers

3VL Molded Case Circuit Breakers up to 1600 A, IEC

General data

Benefits

- The compact design of the 3VL molded case circuit breakers coupled with excellent characteristics fulfills the high demands of today's electrical distribution systems.
- These circuit breakers offer a broad product range, improved technology, space savings and easy operation.
- They are available both in thermal-magnetic (16 A to 630 A) and in electronic versions (63 A to 1,600 A).

Communication

The use of modern communication-capable circuit breakers opens up completely new possibilities in terms of start-up, parameterization, diagnostics, maintenance and operation. This allows many different ways of reducing costs and improving productivity in industrial plants, buildings and infrastructure projects to be achieved:

- Fast and reliable parameterization
- Timely information and response can prevent plant stoppages
- Effective diagnostics management

Measured values are the basis for efficient load management, for drawing up power demand profiles and for assigning power to cost centers.

Communication:

- For molded case circuit breakers with communication function, [see pages 2/128 to 2/144, 2/156 to 2/144](#).
- For communication accessories, [see page 2/207](#).
- For more information, [see also chapter "Measuring Devices and Power Monitoring"](#) and [chapter "Software"](#).

Application

The different versions of 3VL molded case circuit breakers are suitable for the following applications:

- Incoming and outgoing circuit breakers in distribution systems
- Switching and protection devices for motors, transformers and capacitors
- Disconnecting means with features for stopping and switching off in an emergency (main disconnecting means and EMERGENCY-STOP switches) in conjunction with lockable rotary operating mechanisms and terminal covers.

The 3VL molded case circuit breakers are available in the following versions:

1. For line protection (in 3- and 4-pole versions)
The overload and short-circuit releases are designed for the protection of cables, leads and non-motor loads.
2. For motor protection (in 3-pole version)
The overload and short-circuit releases are designed for optimized protection and direct-on-line starting of induction squirrel-cage motors. The circuit breakers for motor protection are susceptible to phase failure and feature an adjustable trip class. The Electronic Trip Units operate with a microprocessor.
3. For starter combinations (in 3-pole version)
These circuit breakers are used both for short-circuit protection as well as for isolating functions, which may be required in starter combinations consisting of motor starter protectors, overload relays and motor contactors. These circuit breakers exclusively feature adjustable, instantaneous short-circuit releases.
4. As non-automatic air circuit breakers (in 3- and 4-pole versions)
These circuit breakers can be used as feeder circuit breakers, main control switches or non-automatic circuit breakers without overload protection. They incorporate an integrated short-circuit self-protection system, eliminating the need for back-up fuses.

Breaking capacity

- N** Circuit breakers with standard breaking capacity N (I_{cu} up to 55 kA at 415 V)
- H** Circuit breakers with high breaking capacity H (I_{cu} up to 70 kA at 415 V)
- L** Circuit breakers with very high breaking capacity L (I_{cu} up to 100 kA at 415 V)

These breaking capacities are indicated in the corresponding tables by the symbols shown on orange backgrounds.

Standards and specifications

3VL molded case circuit breakers comply with:

IEC 60947-1, EN 60947-1,
VDE 0660-100,
IEC 60947-2, EN 60947-2,
VDE 0660-101.

Isolating features according IEC 60947-2, EN 60947-2.

Disconnecting means (main disconnecting means) according to EN 60204 (VDE 0113).

The 3VL molded case circuit breakers comply in addition with requirements for "disconnecting means with features for stopping and switching off in an emergency" (EMERGENCY-STOP switches) in conjunction with lockable rotary operating mechanisms (red-yellow) and terminal covers.

Please contact Siemens for details of other standards.

The Electronic Trip Units of the circuit breakers for motor protection also fulfill IEC 60947-4-1, VDE 0660-102.

VL160X to VL400 circuit breakers can be equipped with a 3VL RCD module. They then comply with IEC 60947-2 Annex B.

The 3VL RCD module complies with IEC 61000-4-2 to IEC 61000-4-6, IEC 61000-4-11 and EN 55011, Class B (equivalent to CISPR 11) with regard to electromagnetic compatibility.

Operating conditions

The 3VL molded case circuit breakers are designed for operation in enclosed areas.

Suitable enclosures must be provided for operation in areas with severe ambient conditions (such as dust, caustic vapors, hazardous gases).

The incoming and outgoing terminals for the circuit breaker can be freely selected. The electrical data remains unaffected.

IE3 ready

As from January 2015, the energy-efficiency class IE3 will be mandatory, with a few exceptions only, for three-phase asynchronous motors. This will have an effect on motors, low-voltage power distribution and electrical installation technology, as well as industrial controls.

For use of 3VL molded case circuit breakers in conjunction with highly energy-efficient IE3 motors, please observe the information on dimensioning and configuring, [see "Configuration Manual for SIRIUS Controls with IE3 Motors"](#), at <http://support.automation.siemens.com/WW/view/en/94770820>.

RCD modules

The RCD module is designed for retrofitting to the circuit breaker. It can also be retrofitted by the customer.

The combination of 3VL molded case circuit breaker and RCD module can be fed from the top or bottom.

All 3VL molded case circuit breakers with RCD modules are available with auxiliary switches, alarm switches, undervoltage and shunt releases.

Protection of plant and equipment against overload or damage by ground faults (ground-fault protection).

The RCD module trips the circuit breaker through vectorial summation current formation for all phase currents if the vectorial sum of the currents in the poles (= the ground fault current) overshoots the pre-set response and delay time values. AC currents and pulsating DC currents are measured (CBR, design A according to EN 60947-2).

Main connections, basic equipment and options



Main connections (for conductor cross-sections, [see below](#))

Circuit breakers	Connection overview and further options				
	Box terminals	Screw terminals with metric thread for flat connection	Circular conductor terminal/multiple feed-in terminals	Rear terminals	Front-accessible connecting bars
VL160X	□	□	x	x	x
VL160	□	□	x	x	x
VL250	□	□	x	x	x
VL400	x	○	x ²⁾³⁾	x	x
VL630	x ¹⁾	○	x ²⁾	x	x
VL800	--	○	x ²⁾	x	x
VL1250	--	○	x ²⁾	x	x
VL1600	--	x	--	x	○

- Scope of supply
- Optional scope of supply
- x Available
- Not available

- ¹⁾ Connecting terminal plate for flexible busbar; not for 690 V AC/600 V DC.
- ²⁾ Multiple feed-in terminal.
- ³⁾ Circular conductor terminal also available.

Conductor cross-sections

Type	VL160X 3VL1	VL160 3VL2	VL250 3VL3	VL400 3VL4	VL630 3VL5	VL800 3VL6	VL1250 3VL7	VL1600 3VL8
Conductor cross-sections								
Box terminals ¹⁾								
• Solid or stranded cable	Copper only	mm ² 2.5 ... 95	2.5 ... 95	25 ... 185	50 ... 300	--	--	--
• Finely stranded with end sleeve		mm ² 2.5 ... 50	2.5 ... 50	25 ... 120	50 ... 240	--	--	--
• Flexible busbar		mm 12 × 10	12 × 10	17 × 10	25 × 10	--	--	--
Connecting terminal plate for flexible busbar ²⁾		mm --	--	--	2 units 10 × 32	--	--	--
Circular conductor terminal for cable ¹⁾								
• Solid or stranded cable	Cu or Al	mm ² 16 ... 70	16 ... 70	25 ... 185	50 ... 300	--	--	--
- With terminal cover	Cu or Al	mm ² 16 ... 150	16 ... 150	120 ... 240	--	--	--	--
• Finely stranded with end sleeve		mm ² 10 ... 50	10 ... 50	25 ... 120	50 ... 240	--	--	--
Multiple feed-in terminal ¹⁾								
• Solid or stranded cable	Cu or Al	mm ² --	--	--	2 units 50 ... 120	2 units 50 ... 240	3 units 50 ... 240	4 units 50 ... 240
- With terminal cover	Cu or Al	mm ² --	--	--	2 units 70 ... 300	--	--	--
• Finely stranded with end sleeve		mm ² --	--	--	2 units 50 ... 95	3 units 50 ... 185	4 units 50 ... 185	--
• Direct connection of busbars	Cu or Al	mm 17 × 7	22 × 7	24 × 7	32 × 10	40 × 10	2 × 40 × 10	2 × 50 × 10
• Screw for connection with screw terminal		M6	M6	M8	M8	M6	M8	M8
Conductor cross-sections for control circuits with terminal connection								
Screw terminals								
• Solid		mm ² 0.75 ... 1.5	0.75 ... 1.5	0.75 ... 1.5	0.75 ... 1.5	0.75 ... 1.5	0.75 ... 1.5	0.75 ... 1.5
• Finely stranded with end sleeve		mm ² 0.75 ... 1.0	0.75 ... 1.0	0.75 ... 1.0	0.75 ... 1.0	0.75 ... 1.0	0.75 ... 1.0	0.75 ... 1.0

¹⁾ Cross-sections according to IEC 60999.

²⁾ Not for 690 V AC/600 V DC.

Molded Case Circuit Breakers

3VL Molded Case Circuit Breakers up to 1600 A, IEC

General data

VL160 to VL1600 Trip Units – Functional overview

Article No. supplement	Releases	Line protection	Line/generator protection	Motor protection	Starter protection	Non-automatic circuit breakers	Function	Setting options					
								L	S ¹⁾	I ¹⁾	G		
								Overload protection	Short-circuit protection (short-time delayed)	Short-circuit protection (instantaneous)	Ground-fault protection		
								$I_r = \times I_n$	$I_{sd} = \times I_r$	t_{sd} [s]	$I_l = \times I_n$	$I_g = \times I_n$	t_g [s]
DK	M	--	--	--	✓	--	I	--	--	--	7 ... 15	--	--
DE	M	--	--	--	--	✓	I	--	--	--	8 ... 18	--	--
EE	M	--	--	--	--	✓	I	--	--	--	8 ... 18	--	--
DA	TM ²⁾	✓	--	--	--	--	LI	1	--	--	9 ... 18 ⁴⁾	--	--
DD	TM ²⁾	✓	--	--	--	--	LI	0.8 ... 1	--	--	9 ... 18 ⁴⁾	--	--
DC	TM ²⁾	✓	--	--	--	--	LI	0.8 ... 1	--	--	5 ... 10	--	--
EH	TM ²⁾	✓	--	--	--	--	LI	1	--	--	9 ... 18 ⁴⁾	--	--
EJ	TM ²⁾	✓	--	--	--	--	LI	0.8 ... 1	--	--	5 ... 10	--	--
EA/EL	TM ²⁾	✓	--	--	--	--	LIN	1	--	--	9 ... 18 ⁴⁾	--	--
EC	TM ²⁾	✓	--	--	--	--	LIN	0.8 ... 1	--	--	5 ... 10	--	--
EM	TM ²⁾	✓	--	--	--	--	LIN	0.8 ... 1	--	--	5 ... 10	--	--
SP	ETU10M ³⁾	--	--	✓	--	--	LI	0.4 ... 1	--	--	1.25 ... 11	--	--
MP	ETU10M ³⁾	--	--	✓	--	--	LI	0.4 ... 1	--	--	1.25 ... 11	--	--
SB	ETU10	✓	--	--	--	--	LI	0.4 ... 1	--	--	1.25 ... 11	--	--
MB	ETU10	✓	--	--	--	--	LI	0.4 ... 1	--	--	1.25 ... 11	--	--
LB	ETU10	✓	--	--	--	--	LI	0.4 ... 1	--	--	1.25 ... 11	--	--
TA	ETU10	✓	--	--	--	--	LIN	0.4 ... 1	--	--	1.25 ... 11	--	--
NA	ETU10	✓	--	--	--	--	LIN	0.4 ... 1	--	--	1.25 ... 11	--	--
LA	ETU10	✓	--	--	--	--	LIN	0.4 ... 1	--	--	1.25 ... 11	--	--
TB	ETU10	✓	--	--	--	--	LI	0.4 ... 1	--	--	1.25 ... 11	--	--
NB	ETU10	✓	--	--	--	--	LI	0.4 ... 1	--	--	1.25 ... 11	--	--
SL	ETU12	✓	--	--	--	--	LIG	0.4 ... 1	--	--	1.25 ... 11	0.6 ... 1, OFF	0.1 ... 0.3
ML	ETU12	✓	--	--	--	--	LIG	0.4 ... 1	--	--	1.25 ... 11	0.6 ... 1, OFF	0.1 ... 0.3
SF	ETU12	✓	--	--	--	--	LIG	0.4 ... 1	--	--	1.25 ... 11	0.6 ... 1, OFF	0.1 ... 0.3
MF	ETU12	✓	--	--	--	--	LIG	0.4 ... 1	--	--	1.25 ... 11	0.6 ... 1, OFF	0.1 ... 0.3
TN	ETU12	✓	--	--	--	--	LING	0.4 ... 1	--	--	1.25 ... 11	0.6 ... 1, OFF	0.1 ... 0.3
NN	ETU12	✓	--	--	--	--	LING	0.4 ... 1	--	--	1.25 ... 11	0.6 ... 1, OFF	0.1 ... 0.3
SE	ETU20	--	✓	--	--	--	LSI	0.4 ... 1	1.5 ... 10	0 ... 0.5	11	--	--
ME	ETU20	--	✓	--	--	--	LSI	0.4 ... 1	1.5 ... 10	0 ... 0.5	11	--	--
LE	ETU20	--	✓	--	--	--	LSI	0.4 ... 1	1.5 ... 10	0 ... 0.5	11	--	--
TE	ETU20	--	✓	--	--	--	LSI	0.4 ... 1	1.5 ... 10	0 ... 0.5	11	--	--
NE	ETU20	--	✓	--	--	--	LSI	0.4 ... 1	1.5 ... 10	0 ... 0.5	11	--	--
TF	ETU20	--	✓	--	--	--	LSIN	0.4 ... 1	1.5 ... 10	0 ... 0.5	11	--	--
NF	ETU20	--	✓	--	--	--	LSIN	0.4 ... 1	1.5 ... 10	0 ... 0.5	11	--	--
LF	ETU20	--	✓	--	--	--	LSIN	0.4 ... 1	1.5 ... 10	0 ... 0.5	11	--	--
SG	ETU22	--	✓	--	--	--	LSIG	0.4 ... 1	1.5 ... 10	0 ... 0.5	11	0.6 ... 1, OFF	0.1 ... 0.3
MG	ETU22	--	✓	--	--	--	LSIG	0.4 ... 1	1.5 ... 10	0 ... 0.5	11	0.6 ... 1, OFF	0.1 ... 0.3
SH	ETU22	--	✓	--	--	--	LSIG	0.4 ... 1	1.5 ... 10	0 ... 0.5	11	0.6 ... 1, OFF	0.1 ... 0.3
MH	ETU22	--	✓	--	--	--	LSIG	0.4 ... 1	1.5 ... 10	0 ... 0.5	11	0.6 ... 1, OFF	0.1 ... 0.3
TH	ETU22	--	✓	--	--	--	LSING	0.4 ... 1	1.5 ... 10	0 ... 0.5	11	0.6 ... 1, OFF	0.1 ... 0.3
NH	ETU22	--	✓	--	--	--	LSING	0.4 ... 1	1.5 ... 10	0 ... 0.5	11	0.6 ... 1, OFF	0.1 ... 0.3
SS	ETU30M ³⁾	--	--	✓	--	--	LI	0.4 ... 1	--	--	6/8/11	--	--
MS	ETU30M ³⁾	--	--	✓	--	--	LI	0.4 ... 1	--	--	6/8/11	--	--
LS	ETU30M ³⁾	--	--	✓	--	--	LI	0.4 ... 1	--	--	6/8/11	--	--
UP	LCD ETU40M ³⁾	--	--	✓	--	--	LI	0.4 ... 1	--	--	1.25 ... 11	--	--
UH	LCD ETU40	--	✓	--	--	--	LI, LS, LSI	0.4 ... 1	1.5 ... 10	0 ... 0.5	1.25 ... 11	--	--
UJ	LCD ETU40	--	✓	--	--	--	LI, LSI, LIN, LSIN	0.4 ... 1	1.5 ... 10	0 ... 0.5	1.25 ... 11	--	--
UL	LCD ETU42	--	✓	--	--	--	LSIG	0.4 ... 1	1.5 ... 10	0 ... 0.5	1.25 ... 11	0.4 ... 1	0.1 ... 0.5
UM	LCD ETU42	--	✓	--	--	--	LSIG	0.4 ... 1	1.5 ... 10	0 ... 0.5	1.25 ... 11	0.4 ... 1	0.1 ... 0.5
UN	LCD ETU42	--	✓	--	--	--	LSIG, LSING	0.4 ... 1	1.5 ... 10	0 ... 0.5	1.25 ... 11	0.4 ... 1	0.1 ... 0.5

✓ Function is available.

-- Function not available.

¹⁾ Size dependent.

²⁾ TM up to $I_n = 630$ A.

³⁾ Motor protection up to $I_n = 500$ A.

⁴⁾ Non-adjustable.

Article No. supplement	Releases	Thermal image	Phase failure	Communication-capable	Ground-fault protection	Number of poles	N pole protected ¹⁾	I_{t}^2 (ON/OFF)	Trip class (tc)	Time-lag class (I_R)	Thermal-magnetic overcurrent releases	Magnetic releases	Electronic Trip Unit	LCD display
DK	M	--	--	--	--	3	--	--	--	--	--	✓	--	--
DE	M	--	--	--	--	3	--	--	--	--	--	✓	--	--
EE	M	--	--	--	--	4	--	--	--	--	--	✓	--	--
DA	TM ²⁾	✓	--	--	--	3	--	--	--	--	✓	--	--	--
DD	TM ²⁾	✓	--	--	--	3	--	--	--	--	✓	--	--	--
DC	TM ²⁾	✓	--	--	--	3	--	--	--	--	✓	--	--	--
EH	TM ²⁾	✓	--	--	--	4	--	--	--	--	✓	--	--	--
EJ	TM ²⁾	✓	--	--	--	4	--	--	--	--	✓	--	--	--
EA/EL	TM ²⁾	✓	--	--	--	4	100 %	--	--	--	✓	--	--	--
EC	TM ²⁾	✓	--	--	--	4	60 %	--	--	--	✓	--	--	--
EM	TM ²⁾	✓	--	--	--	4	100 %	--	--	--	✓	--	--	--
SP	ETU10M ³⁾	✓	40 % I_R	--	--	3	--	--	10	--	--	--	✓	--
MP	ETU10M ³⁾	✓	40 % I_R	✓ ⁴⁾	--	3	--	--	10	--	--	--	✓	--
SB	ETU10	✓	--	--	--	3	--	--	--	2.5 ... 30	--	--	✓	--
MB	ETU10	✓	--	✓ ⁴⁾	--	3	--	--	--	2.5 ... 30	--	--	✓	--
LB	ETU10	✓	--	--	--	3	--	--	--	2.5 ... 30	--	--	✓	--
TA	ETU10	✓	--	--	--	4	50/100 %	--	--	2.5 ... 30	--	--	✓	--
NA	ETU10	✓	--	✓ ⁴⁾	--	4	50/100 %	--	--	2.5 ... 30	--	--	✓	--
LA	ETU10	✓	--	--	--	4	50/100 %	--	--	2.5 ... 30	--	--	✓	--
TB	ETU10	✓	--	--	--	4	--	--	--	2.5 ... 30	--	--	✓	--
NB	ETU10	✓	--	✓ ⁴⁾	--	4	--	--	--	2.5 ... 30	--	--	✓	--
SL	ETU12	✓	--	--	①	3	--	--	--	2.5 ... 30	--	--	✓	--
ML	ETU12	✓	--	✓ ⁴⁾	①	3	--	--	--	2.5 ... 30	--	--	✓	--
SF	ETU12	✓	--	--	②	3	--	--	--	2.5 ... 30	--	--	✓	--
MF	ETU12	✓	--	✓ ⁴⁾	②	3	--	--	--	2.5 ... 30	--	--	✓	--
TN	ETU12	✓	--	--	②	4	50/100 %	--	--	2.5 ... 30	--	--	✓	--
NN	ETU12	✓	--	✓ ⁴⁾	②	4	50/100 %	--	--	2.5 ... 30	--	--	✓	--
SE	ETU20	✓	--	--	--	3	--	✓	--	--	--	--	✓	--
ME	ETU20	✓	--	✓ ⁴⁾	--	3	--	✓	--	--	--	--	✓	--
LE	ETU20	✓	--	--	--	3	--	✓	--	--	--	--	✓	--
TE	ETU20	✓	--	--	--	4	--	✓	--	--	--	--	✓	--
NE	ETU20	✓	--	✓ ⁴⁾	--	4	--	✓	--	--	--	--	✓	--
TF	ETU20	✓	--	--	--	4	50/100 %	✓	--	--	--	--	✓	--
NF	ETU20	✓	--	✓ ⁴⁾	--	4	50/100 %	✓	--	--	--	--	✓	--
LF	ETU20	✓	--	--	--	4	50/100 %	✓	--	--	--	--	✓	--
SG	ETU22	✓	--	--	①	3	--	✓	--	--	--	--	✓	--
MG	ETU22	✓	--	✓ ⁴⁾	①	3	--	✓	--	--	--	--	✓	--
SH	ETU22	✓	--	--	②	3	--	✓	--	--	--	--	✓	--
MH	ETU22	✓	--	✓ ⁴⁾	②	3	--	✓	--	--	--	--	✓	--
TH	ETU22	✓	--	--	②	4	50/100 %	✓	--	--	--	--	✓	--
NH	ETU22	✓	--	✓ ⁴⁾	②	4	50/100 %	✓	--	--	--	--	✓	--
SS	ETU30M ³⁾	✓	40 % I_R	--	--	3	--	--	10, 20, 30	--	--	--	✓	--
MS	ETU30M ³⁾	✓	40 % I_R	✓ ⁴⁾	--	3	--	--	10, 20, 30	--	--	--	✓	--
LS	ETU30M ³⁾	✓	40 % I_R	--	--	3	--	--	10, 20, 30	--	--	--	✓	--
UP	LCD ETU40M ³⁾	✓	5 ... 50 % I_R	✓ ⁴⁾	--	3	--	--	5, 10, 15, 20, 30	--	--	--	✓	✓
UH	LCD ETU40	✓	--	✓ ⁴⁾	--	3	--	✓	--	2.5 ... 30	--	--	✓	✓
UJ	LCD ETU40	✓	--	✓ ⁴⁾	--	4	50 ... 100 %, OFF	✓	--	2.5 ... 30	--	--	✓	✓
UL	LCD ETU42	✓	--	✓ ⁴⁾	①	3	--	✓	--	2.5 ... 30	--	--	✓	✓
UM	LCD ETU42	✓	--	✓ ⁴⁾	①/③	3	--	✓	--	2.5 ... 30	--	--	✓	✓
UN	LCD ETU42	✓	--	✓ ⁴⁾	②	4	50 ... 100 %, OFF	✓	--	2.5 ... 30	--	--	✓	✓

Ground-fault protection

- ① Vectorial summation current formation (3-conductor system)
- ② Vectorial summation current formation (4-conductor system)
- ③ Direct detection of ground-fault current in the neutral point of the transformer

¹⁾ Size dependent.

²⁾ TM up to $I_n = 630$ A.

³⁾ Motor protection up to $I_n = 500$ A.

⁴⁾ With COM20/COM21.

✓ Function is available.

-- Function not available.

Molded Case Circuit Breakers

3VL Molded Case Circuit Breakers up to 1600 A, IEC

3-pole

Selection and ordering data

Type	Rated current I_n	Current setting range of the inverse-time delayed overcurrent protection "L" I_R	Operating current of the instantaneous short-circuit protection "I" I_i	DT	I_{cu} up to 55 kA at 415 V, standard breaking capacity N See Overview .					(N)	
	A	A	A		Article No. Article No. supplement, see page 2/172; www.siemens.com/product?Article No.	Basic price per PU	PU (UNIT, SET, M)	PS*/P. unit	PG	Weight per PU approx.	kg

3-pole, fixed-mounted, for line protection, 16 A to 160 A, thermal-magnetic overcurrent releases LI

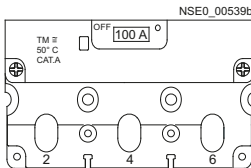

Line protection, TM, LI function

With non-adjustable thermal overcurrent releases, non-adjustable short-circuit releases

VL160X/ 3VL1	16	20	25	32	40	50	63	80	100	125	160	Article No.	PU	PS*/P. unit	PG	Weight per PU approx.
	16	20	25	32	40	50	63	80	100	125	160	3VL1796-1DA3□-□□□□	1	1 unit	1CC	1,900
												3VL1702-1DA3□-□□□□	1	1 unit	1CC	1,900
												3VL1725-1DA3□-□□□□	1	1 unit	1CC	2,000
												3VL1703-1DA3□-□□□□	1	1 unit	1CC	2,000
												3VL1704-1DA3□-□□□□	1	1 unit	1CC	2,000
												3VL1705-1DA3□-□□□□	1	1 unit	1CC	2,000
												3VL1706-1DA3□-□□□□	1	1 unit	1CC	2,000
												3VL1708-1DA3□-□□□□	1	1 unit	1CC	2,000
												3VL1710-1DA3□-□□□□	1	1 unit	1CC	2,000
												3VL1712-1DA3□-□□□□	1	1 unit	1CC	2,000
												3VL1716-1DA3□-□□□□	1	1 unit	1CC	2,000

Connection type can be selected by assignment of the 12th position of the Article No.

- Connection with box terminal **3**
- Connection with flat screw terminal not in conjunction with RCD module¹⁾ **6**

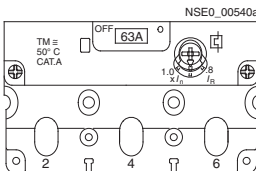

Line protection, TM, LI function

With adjustable thermal overcurrent releases, non-adjustable short-circuit releases

VL160X/ 3VL1	20	32	40	50	63	80	100	125	160	Article No.	PU	PS*/P. unit	PG	Weight per PU approx.
	16 ... 20	25 ... 32	32 ... 40	40 ... 50	50 ... 63	63 ... 80	80 ... 100	100 ... 125	125 ... 160	3VL1702-1DD3□-□□□□	1	1 unit	1CC	1,900
										3VL1703-1DD3□-□□□□	1	1 unit	1CC	2,000
										3VL1704-1DD3□-□□□□	1	1 unit	1CC	2,000
										3VL1705-1DD3□-□□□□	1	1 unit	1CC	2,000
										3VL1706-1DD3□-□□□□	1	1 unit	1CC	2,000
										3VL1708-1DD3□-□□□□	1	1 unit	1CC	2,000
										3VL1710-1DD3□-□□□□	1	1 unit	1CC	2,000
										3VL1712-1DD3□-□□□□	1	1 unit	1CC	2,000
										3VL1716-1DD3□-□□□□	1	1 unit	1CC	2,000

Connection type can be selected by assignment of the 12th position of the Article No.

- Connection with box terminal **3**
- Connection with flat screw terminal not in conjunction with RCD module¹⁾ **6**

¹⁾ When the circuit breaker with flat screw terminal is ordered, the basic price is reduced.

Molded Case Circuit Breakers

3VL Molded Case Circuit Breakers up to 1600 A, IEC

3-pole

2

DT	I_{cu} up to 70 kA at 415 V, high breaking capacity H					(H)	DT	I_{cu} up to 100 kA at 415 V, very high breaking capacity L					(L)
	Article No.	Basic price per PU	PU (UNIT, SET, M)	PS*/P. unit	PG	Weight per PU approx. kg		Article No.	Basic price per PU	PU (UNIT, SET, M)	PS*/P. unit	PG	Weight per PU approx. kg

3VL1796-2DA3□-□□□□	1	1 unit	1CC	1.900	--
3VL1702-2DA3□-□□□□	1	1 unit	1CC	1.900	--
3VL1725-2DA3□-□□□□	1	1 unit	1CC	2.000	--
3VL1703-2DA3□-□□□□	1	1 unit	1CC	2.000	--
3VL1704-2DA3□-□□□□	1	1 unit	1CC	2.000	--
3VL1705-2DA3□-□□□□	1	1 unit	1CC	2.000	--
3VL1706-2DA3□-□□□□	1	1 unit	1CC	2.000	--
3VL1708-2DA3□-□□□□	1	1 unit	1CC	2.000	--
3VL1710-2DA3□-□□□□	1	1 unit	1CC	2.000	--
3VL1712-2DA3□-□□□□	1	1 unit	1CC	2.000	--
3VL1716-2DA3□-□□□□	1	1 unit	1CC	2.000	--

3
6

3VL1702-2DD3□-□□□□	1	1 unit	1CC	1.900	--
3VL1703-2DD3□-□□□□	1	1 unit	1CC	2.000	--
3VL1704-2DD3□-□□□□	1	1 unit	1CC	2.000	--
3VL1705-2DD3□-□□□□	1	1 unit	1CC	2.000	--
3VL1706-2DD3□-□□□□	1	1 unit	1CC	2.000	--
3VL1708-2DD3□-□□□□	1	1 unit	1CC	2.000	--
3VL1710-2DD3□-□□□□	1	1 unit	1CC	2.000	--
3VL1712-2DD3□-□□□□	1	1 unit	1CC	2.000	--
3VL1716-2DD3□-□□□□	1	1 unit	1CC	2.000	--

3
6

Molded Case Circuit Breakers

3VL Molded Case Circuit Breakers up to 1600 A, IEC

3-pole

2

Type	Rated current I_n	Current setting of the inverse-time delayed overcurrent protection "L" I_R	Operating current of the instantaneous short-circuit protection "I" I_i	DT	I_{cu} up to 55 kA at 415 V, standard breaking capacity N See "Overview".					
	A	A	A		Article No.	Basic price per PU	PU (UNIT, SET, M)	PS*/P. unit	PG	Weight per PU approx. kg

3-pole, fixed-mounted, for line protection, 50 A to 630 A, thermal-magnetic overcurrent releases LI

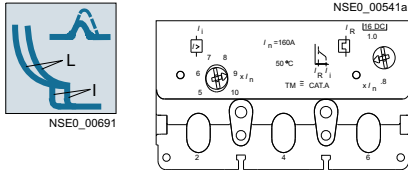

Line protection, TM, LI function

With adjustable thermal overcurrent releases, adjustable short-circuit releases

VL160/3VL2	50	40 ... 50	300 ... 600		3VL2705-1DC3-□□□□		1	1 unit	1CC	2,200
	63	50 ... 63	300 ... 600		3VL2706-1DC3-□□□□		1	1 unit	1CC	2,200
	80	63 ... 80	400 ... 800		3VL2708-1DC3-□□□□		1	1 unit	1CC	2,200
	100	80 ... 100	500 ... 1000		3VL2710-1DC3-□□□□		1	1 unit	1CC	2,200
	125	100 ... 125	625 ... 1250		3VL2712-1DC3-□□□□		1	1 unit	1CC	2,200
	160	125 ... 160	800 ... 1600		3VL2716-1DC3-□□□□		1	1 unit	1CC	2,200
VL250/3VL3	200	160 ... 200	1000 ... 2000		3VL3720-1DC3-□□□□		1	1 unit	1CC	2,300
	250	200 ... 250	1250 ... 2500		3VL3725-1DC3-□□□□		1	1 unit	1CC	2,300

Connection type can be selected by assignment of the 12th position of the Article No.

- Connection with box terminal
- Connection with flat screw terminal¹⁾

3
6

VL400/3VL4	200	160 ... 200	1000 ... 2000		3VL4720-1DC36-□□□□		1	1 unit	1CC	5,700
	250	200 ... 250	1250 ... 2500		3VL4725-1DC36-□□□□		1	1 unit	1CC	5,700
	315	250 ... 315	1575 ... 3150		3VL4731-1DC36-□□□□		1	1 unit	1CC	5,700
	400	320 ... 400	2000 ... 4000		3VL4740-1DC36-□□□□		1	1 unit	1CC	5,700
VL630/3VL5	315	250 ... 315	1575 ... 3150		3VL5731-1DC36-□□□□		1	1 unit	1CC	9,000
	400	320 ... 400	2000 ... 4000		3VL5740-1DC36-□□□□		1	1 unit	1CC	9,000
	500	400 ... 500	2500 ... 5000		3VL5750-1DC36-□□□□		1	1 unit	1CC	9,000
	630	500 ... 630	3150 ... 6300		3VL5763-1DC36-□□□□		1	1 unit	1CC	9,000

3-pole, fixed-mounted, for line protection, 63 A to 1600 A, Electronic Trip Units LI

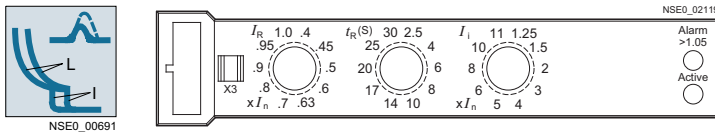

ETU10, LI function

With adjustable overcurrent releases, adjustable short-circuit releases

VL160/3VL2	63	25 ... 63	1.25 ... 11 × I_n		3VL2706-1□□3□-□□□□		1	1 unit	1CC	2,400
	100	40 ... 100	1.25 ... 11 × I_n		3VL2710-1□□3□-□□□□		1	1 unit	1CC	2,400
	160	64 ... 160	1.25 ... 11 × I_n		3VL2716-1□□3□-□□□□		1	1 unit	1CC	2,400
VL250/3VL3	200	80 ... 200	1.25 ... 11 × I_n		3VL3720-1□□3□-□□□□		1	1 unit	1CC	2,500
	250	100 ... 250	1.25 ... 11 × I_n		3VL3725-1□□3□-□□□□		1	1 unit	1CC	2,500

Connection type can be selected by assignment of the 12th position of the Article No.

- Connection with box terminal
- Connection with flat screw terminal¹⁾

3
6

VL400/3VL4	315	128 ... 315	1.25 ... 11 × I_n		3VL4731-1□□36-□□□□		1	1 unit	1CC	5,900
	400	160 ... 400	1.25 ... 11 × I_n		3VL4740-1□□36-□□□□		1	1 unit	1CC	5,900
VL630/3VL5	630	252 ... 630	1.25 ... 10 × I_n		3VL5763-1□□36-□□□□		1	1 unit	1CC	9,300
VL800/3VL6	800	320 ... 800	1.25 ... 8 × I_n		3VL6780-1□□36-□□□□		1	1 unit	1CC	16,000
VL1250/3VL7	1000	400 ... 1000	1.25 ... 11 × I_n		3VL7710-1□□36-□□□□		1	1 unit	1CC	25,000
	1250	500 ... 1250	1.25 ... 11 × I_n		3VL7712-1□□36-□□□□		1	1 unit	1CC	25,000
VL1600/3VL8 ²⁾	1600	640 ... 1600	1.25 ... 9 × I_n		3VL8716-1□□30-□□□□		1	1 unit	1CC	31,300

- Without communication preparation
- With communication preparation
- Marine engineering-certified LRS, DNV, GL and BV (not communication-ready)

SB
MB
LB

¹⁾ When the circuit breaker with flat screw terminal is ordered, the basic price is reduced.

²⁾ Front busbar connection pieces are included in the scope of supply and are to be fitted by the customer.

Communication:

- For accessories, see page 2/207.
- For more information, see also chapter "Measuring Devices and Power Monitoring" and chapter "Software".

Molded Case Circuit Breakers

3VL Molded Case Circuit Breakers up to 1600 A, IEC

3-pole

2

DT	I_{cu} up to 70 kA at 415 V, high breaking capacity H	(H)	DT	I_{cu} up to 100 kA at 415 V, very high breaking capacity L	(L)						
Article No.	Basic price per PU	PU (UNIT, SET, M)	PS*/P. unit	PG	Weight per PU approx. kg	Article No.	Basic price per PU	PU (UNIT, SET, M)	PS*/P. unit	PG	Weight per PU approx. kg

3VL2705-2DC3□-□□□□		1	1 unit	1CC	2.200	3VL2705-3DC3□-□□□□		1	1 unit	1CC	2.200
3VL2706-2DC3□-□□□□		1	1 unit	1CC	2.200	3VL2706-3DC3□-□□□□		1	1 unit	1CC	2.200
3VL2708-2DC3□-□□□□		1	1 unit	1CC	2.200	3VL2708-3DC3□-□□□□		1	1 unit	1CC	2.200
3VL2710-2DC3□-□□□□		1	1 unit	1CC	2.200	3VL2710-3DC3□-□□□□		1	1 unit	1CC	2.200
3VL2712-2DC3□-□□□□		1	1 unit	1CC	2.200	3VL2712-3DC3□-□□□□		1	1 unit	1CC	2.200
3VL2716-2DC3□-□□□□		1	1 unit	1CC	2.200	3VL2716-3DC3□-□□□□		1	1 unit	1CC	2.200
3VL3720-2DC3□-□□□□		1	1 unit	1CC	2.300	3VL3720-3DC3□-□□□□		1	1 unit	1CC	2.300
3VL3725-2DC3□-□□□□		1	1 unit	1CC	2.300	3VL3725-3DC3□-□□□□		1	1 unit	1CC	2.300

3
6

3
6

3VL4720-2DC36-□□□□		1	1 unit	1CC	5.700	3VL4720-3DC36-□□□□		1	1 unit	1CC	5.700
3VL4725-2DC36-□□□□		1	1 unit	1CC	5.700	3VL4725-3DC36-□□□□		1	1 unit	1CC	5.700
3VL4731-2DC36-□□□□		1	1 unit	1CC	5.700	3VL4731-3DC36-□□□□		1	1 unit	1CC	5.700
3VL4740-2DC36-□□□□		1	1 unit	1CC	5.700	3VL4740-3DC36-□□□□		1	1 unit	1CC	5.700
3VL5731-2DC36-□□□□		1	1 unit	1CC	9.000	3VL5731-3DC36-□□□□		1	1 unit	1CC	9.000
3VL5740-2DC36-□□□□		1	1 unit	1CC	9.000	3VL5740-3DC36-□□□□		1	1 unit	1CC	9.000
3VL5750-2DC36-□□□□		1	1 unit	1CC	9.000	3VL5750-3DC36-□□□□		1	1 unit	1CC	9.000
3VL5763-2DC36-□□□□		1	1 unit	1CC	9.000	3VL5763-3DC36-□□□□		1	1 unit	1CC	9.000

3VL2706-2□□3□-□□□□		1	1 unit	1CC	2.400	3VL2706-3□□3□-□□□□		1	1 unit	1CC	2.400
3VL2710-2□□3□-□□□□		1	1 unit	1CC	2.400	3VL2710-3□□3□-□□□□		1	1 unit	1CC	2.400
3VL2716-2□□3□-□□□□		1	1 unit	1CC	2.400	3VL2716-3□□3□-□□□□		1	1 unit	1CC	2.400
3VL3720-2□□3□-□□□□		1	1 unit	1CC	2.500	3VL3720-3□□3□-□□□□		1	1 unit	1CC	2.500
3VL3725-2□□3□-□□□□		1	1 unit	1CC	2.500	3VL3725-3□□3□-□□□□		1	1 unit	1CC	2.500

3
6

3
6

3VL4731-2□□36-□□□□		1	1 unit	1CC	5.900	3VL4731-3□□36-□□□□		1	1 unit	1CC	5.900
3VL4740-2□□36-□□□□		1	1 unit	1CC	5.900	3VL4740-3□□36-□□□□		1	1 unit	1CC	5.900
3VL5763-2□□36-□□□□		1	1 unit	1CC	9.300	3VL5763-3□□36-□□□□		1	1 unit	1CC	9.300
3VL6780-2□□36-□□□□		1	1 unit	1CC	16.000	3VL6780-3□□36-□□□□		1	1 unit	1CC	16.000
3VL7710-2□□36-□□□□		1	1 unit	1CC	25.000	3VL7710-3□□36-□□□□		1	1 unit	1CC	25.000
3VL7712-2□□36-□□□□		1	1 unit	1CC	25.000	3VL7712-3□□36-□□□□		1	1 unit	1CC	25.000
3VL8716-2□□30-□□□□		1	1 unit	1CC	31.300	3VL8716-3□□30-□□□□		1	1 unit	1CC	31.300

SB
MB
LB

SB
MB
LB

Molded Case Circuit Breakers

3VL Molded Case Circuit Breakers up to 1600 A, IEC

3-pole

2

Type	Rated current I_n	Current setting of the inverse-time delayed overcurrent protection "L" I_R	Operating current of the instantaneous short-circuit protection "I" I_i	Ground-fault protection "G" I_g	DT	I_{cu} up to 55 kA at 415 V, standard breaking capacity N See "Overview".					(N)	
	A	A	A	A		Article No. Article No. supplement, see page 2/172; www.siemens.com/product?Article No.	Price	PU (UNIT, SET, M)	PS*/P. unit	PG	Weight per PU approx.	kg

3-pole, fixed-mounted, for line protection, 63 A to 1600 A, Electronic Trip Units LIG

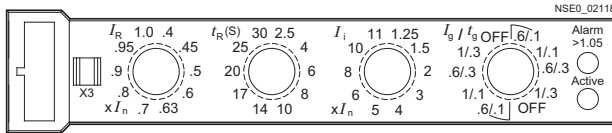

ETU12, LIG function for 3-wire three-phase systems

With adjustable overcurrent releases, adjustable short-circuit releases, vectorial summation current formation, ground fault delay $t_g = 0.1 \dots 0.3$ s, ground fault function (G) can be switched off.

VL160/3VL2	63	25 ... 63	1.25 ... $11 \times I_n$	0.6 ... $1 \times I_n$, OFF	3VL2706-10030-0000	1	1 unit	1CC	2.400
	100	40 ... 100	1.25 ... $11 \times I_n$	0.6 ... $1 \times I_n$, OFF	3VL2710-10030-0000	1	1 unit	1CC	2.400
	160	64 ... 160	1.25 ... $11 \times I_n$	0.6 ... $1 \times I_n$, OFF	3VL2716-10030-0000	1	1 unit	1CC	2.400
VL250/3VL3	200	80 ... 200	1.25 ... $11 \times I_n$	0.6 ... $1 \times I_n$, OFF	3VL3720-10030-0000	1	1 unit	1CC	2.500
	250	100 ... 250	1.25 ... $11 \times I_n$	0.6 ... $1 \times I_n$, OFF	3VL3725-10030-0000	1	1 unit	1CC	2.500

Connection type can be selected by assignment of the 12th position of the Article No.

- Connection with box terminal
- Connection with screw terminal¹⁾

3
6

VL400/3VL4	315	128 ... 315	1.25 ... $11 \times I_n$	0.6 ... $1 \times I_n$, OFF	3VL4731-10036-0000	1	1 unit	1CC	5.900
	400	160 ... 400	1.25 ... $11 \times I_n$	0.6 ... $1 \times I_n$, OFF	3VL4740-10036-0000	1	1 unit	1CC	5.900
VL630/3VL5	630	252 ... 630	1.25 ... $10 \times I_n$	0.6 ... $1 \times I_n$, OFF	3VL5763-10036-0000	1	1 unit	1CC	9.300
VL800/3VL6	800	320 ... 800	1.25 ... $8 \times I_n$	0.6 ... $1 \times I_n$, OFF	3VL6780-10036-0000	1	1 unit	1CC	16.000
VL1250/3VL7	1000	400 ... 1000	1.25 ... $11 \times I_n$	0.6 ... $1 \times I_n$, OFF	3VL7710-10036-0000	1	1 unit	1CC	25.000
	1250	500 ... 1250	1.25 ... $11 \times I_n$	0.6 ... $1 \times I_n$, OFF	3VL7712-10036-0000	1	1 unit	1CC	25.000
VL1600/3VL8 ²⁾	1600	640 ... 1600	1.25 ... $9 \times I_n$	0.6 ... $1 \times I_n$, OFF	3VL8716-10030-0000	1	1 unit	1CC	31.300

- Without communication preparation
- With communication preparation

SL
ML

3-pole, fixed-mounted, for line protection, 63 A to 1600 A, Electronic Trip Units LIG

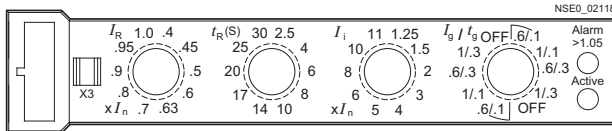

ETU12, LIG function for 4-wire three-phase systems

With adjustable overcurrent releases, adjustable short-circuit releases, vectorial summation current formation, external current transformers required in addition, see page 2/206. Ground fault delay $t_g = 0.1 \dots 0.3$ s, ground fault function (G) can be switched off.

VL160/3VL2	63	25 ... 63	1.25 ... $11 \times I_n$	0.6 ... $1 \times I_n$, OFF	3VL2706-10030-0000	1	1 unit	1CC	2.400
	100	40 ... 100	1.25 ... $11 \times I_n$	0.6 ... $1 \times I_n$, OFF	3VL2710-10030-0000	1	1 unit	1CC	2.400
	160	64 ... 160	1.25 ... $11 \times I_n$	0.6 ... $1 \times I_n$, OFF	3VL2716-10030-0000	1	1 unit	1CC	2.400
VL250/3VL3	200	80 ... 200	1.25 ... $11 \times I_n$	0.6 ... $1 \times I_n$, OFF	3VL3720-10030-0000	1	1 unit	1CC	2.500
	250	100 ... 250	1.25 ... $11 \times I_n$	0.6 ... $1 \times I_n$, OFF	3VL3725-10030-0000	1	1 unit	1CC	2.500

Connection type can be selected by assignment of the 12th position of the Article No.

- Connection with box terminal
- Connection with screw terminal¹⁾

3
6

VL400/3VL4	315	128 ... 315	1.25 ... $11 \times I_n$	0.6 ... $1 \times I_n$, OFF	3VL4731-10036-0000	1	1 unit	1CC	5.900
	400	160 ... 400	1.25 ... $11 \times I_n$	0.6 ... $1 \times I_n$, OFF	3VL4740-10036-0000	1	1 unit	1CC	5.900
VL630/3VL5	630	252 ... 630	1.25 ... $10 \times I_n$	0.6 ... $1 \times I_n$, OFF	3VL5763-10036-0000	1	1 unit	1CC	9.300
VL800/3VL6	800	320 ... 800	1.25 ... $8 \times I_n$	0.6 ... $1 \times I_n$, OFF	3VL6780-10036-0000	1	1 unit	1CC	16.000
VL1250/3VL7	1000	400 ... 1000	1.25 ... $11 \times I_n$	0.6 ... $1 \times I_n$, OFF	3VL7710-10036-0000	1	1 unit	1CC	25.000
	1250	500 ... 1250	1.25 ... $11 \times I_n$	0.6 ... $1 \times I_n$, OFF	3VL7712-10036-0000	1	1 unit	1CC	25.000
VL1600/3VL8 ²⁾	1600	640 ... 1600	1.25 ... $9 \times I_n$	0.6 ... $1 \times I_n$, OFF	3VL8716-10030-0000	1	1 unit	1CC	31.300

- Without communication preparation
- With communication preparation

SF
MF

¹⁾ When the circuit breaker with flat screw terminal is ordered, the basic price is reduced.

²⁾ Front busbar connection pieces are included in the scope of supply and are to be fitted by the customer.

Molded Case Circuit Breakers

3VL Molded Case Circuit Breakers up to 1600 A, IEC

3-pole

2

DT I_{cu} up to 70 kA at 415 V, high breaking capacity H						DT I_{cu} up to 100 kA at 415 V, very high breaking capacity L					
Article No.	Price	PU (UNIT, SET, M)	PS*/P. unit	PG	Weight per PU approx. kg	Article No.	Price	PU (UNIT, SET, M)	PS*/P. unit	PG	Weight per PU approx. kg

3VL2706-2□□3□-□□□□	1	1 unit	1CC	2.400
3VL2710-2□□3□-□□□□	1	1 unit	1CC	2.400
3VL2716-2□□3□-□□□□	1	1 unit	1CC	2.400
3VL3720-2□□3□-□□□□	1	1 unit	1CC	2.500
3VL3725-2□□3□-□□□□	1	1 unit	1CC	2.500

3VL2706-3□□3□-□□□□	1	1 unit	1CC	2.400
3VL2710-3□□3□-□□□□	1	1 unit	1CC	2.400
3VL2716-3□□3□-□□□□	1	1 unit	1CC	2.400
3VL3720-3□□3□-□□□□	1	1 unit	1CC	2.500
3VL3725-3□□3□-□□□□	1	1 unit	1CC	2.500

3
6

3
6

3VL4731-2□□36-□□□□	1	1 unit	1CC	5.900
3VL4740-2□□36-□□□□	1	1 unit	1CC	5.900
3VL5763-2□□36-□□□□	1	1 unit	1CC	9.300
3VL6780-2□□36-□□□□	1	1 unit	1CC	16.000
3VL7710-2□□36-□□□□	1	1 unit	1CC	25.000
3VL7712-2□□36-□□□□	1	1 unit	1CC	25.000
3VL8716-2□□30-□□□□	1	1 unit	1CC	31.300

3VL4731-3□□36-□□□□	1	1 unit	1CC	5.900
3VL4740-3□□36-□□□□	1	1 unit	1CC	5.900
3VL5763-3□□36-□□□□	1	1 unit	1CC	9.300
3VL6780-3□□36-□□□□	1	1 unit	1CC	16.000
3VL7710-3□□36-□□□□	1	1 unit	1CC	25.000
3VL7712-3□□36-□□□□	1	1 unit	1CC	25.000
3VL8716-3□□30-□□□□	1	1 unit	1CC	31.300

SL
ML

SL
ML

3VL2706-2□□3□-□□□□	1	1 unit	1CC	2.400
3VL2710-2□□3□-□□□□	1	1 unit	1CC	2.400
3VL2716-2□□3□-□□□□	1	1 unit	1CC	2.400
3VL3720-2□□3□-□□□□	1	1 unit	1CC	2.500
3VL3725-2□□3□-□□□□	1	1 unit	1CC	2.500

3VL2706-3□□3□-□□□□	1	1 unit	1CC	2.400
3VL2710-3□□3□-□□□□	1	1 unit	1CC	2.400
3VL2716-3□□3□-□□□□	1	1 unit	1CC	2.400
3VL3720-3□□3□-□□□□	1	1 unit	1CC	2.500
3VL3725-3□□3□-□□□□	1	1 unit	1CC	2.500

3
6

3
6

3VL4731-2□□36-□□□□	1	1 unit	1CC	5.900
3VL4740-2□□36-□□□□	1	1 unit	1CC	5.900
3VL5763-2□□36-□□□□	1	1 unit	1CC	9.300
3VL6780-2□□36-□□□□	1	1 unit	1CC	16.000
3VL7710-2□□36-□□□□	1	1 unit	1CC	25.000
3VL7712-2□□36-□□□□	1	1 unit	1CC	25.000
3VL8716-2□□30-□□□□	1	1 unit	1CC	31.300

3VL4731-3□□36-□□□□	1	1 unit	1CC	5.900
3VL4740-3□□36-□□□□	1	1 unit	1CC	5.900
3VL5763-3□□36-□□□□	1	1 unit	1CC	9.300
3VL6780-3□□36-□□□□	1	1 unit	1CC	16.000
3VL7710-3□□36-□□□□	1	1 unit	1CC	25.000
3VL7712-3□□36-□□□□	1	1 unit	1CC	25.000
3VL8716-3□□30-□□□□	1	1 unit	1CC	31.300

SF
MF

SF
MF

Communication:

- For accessories, see page 2/207.

- For more information, see also chapter "Measuring Devices and Power Monitoring" and chapter "Software".

Molded Case Circuit Breakers

3VL Molded Case Circuit Breakers up to 1600 A, IEC

3-pole

2

Type	Rated current I_n	Current setting of the inverse-time delayed overcurrent protection "L" I_R	Operating current of the instantaneous short-circuit protection "I" I_I	S function short-circuit protection (short-time delayed) S	DT	I_{cu} up to 55 kA at 415 V, standard breaking capacity N See "Overview".					(N)
	A	A	A	A	A	Article No. Article No. supplement, see page 2/172; www.siemens.com/product?Article No.	Price	PU (UNIT, SET, M)	PS*/P. unit	PG	Weight per PU approx. kg

3-pole, fixed-mounted, for line protection – generator protection, 63 A to 1600 A, Electronic Trip Units LSI

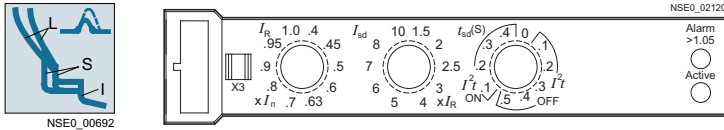

ETU20, LSI function for time-based discrimination

With adjustable overcurrent releases, non-adjustable short-circuit releases, short-circuit delay ($t_{sd} = 0$ to 0.5 s)

Model	Rated current I_n	Overcurrent release I_R	Instantaneous release I_I	Short-circuit release I_T	Article No.	PU	PS*/P. unit	PG	Weight per PU approx. (kg)
VL160/3VL2	63	0.4 ... 1.0 × I_n	11 × I_n	1.5 ... 10 × I_R	3VL2706-1□□3□-□□□□	1	1 unit	1CC	2.400
	100	0.4 ... 1.0 × I_n	11 × I_n	1.5 ... 10 × I_R	3VL2710-1□□3□-□□□□	1	1 unit	1CC	2.400
	160	0.4 ... 1.0 × I_n	11 × I_n	1.5 ... 10 × I_R	3VL2716-1□□3□-□□□□	1	1 unit	1CC	2.400
VL250/3VL3	200	0.4 ... 1.0 × I_n	11 × I_n	1.5 ... 10 × I_R	3VL3720-1□□3□-□□□□	1	1 unit	1CC	2.500
	250	0.4 ... 1.0 × I_n	11 × I_n	1.5 ... 10 × I_R	3VL3725-1□□3□-□□□□	1	1 unit	1CC	2.500

Connection type can be selected by assignment of the 12th position of the Article No.

- Connection with box terminal **3**
- Connection with screw terminal¹⁾ **6**

Model	Rated current I_n	Overcurrent release I_R	Instantaneous release I_I	Short-circuit release I_T	Article No.	PU	PS*/P. unit	PG	Weight per PU approx. (kg)
VL400/3VL4	315	0.4 ... 1.0 × I_n	11 × I_n	1.5 ... 10 × I_R	3VL4731-1□□36-□□□□	1	1 unit	1CC	5.900
	400	0.4 ... 1.0 × I_n	11 × I_n	1.5 ... 10 × I_R	3VL4740-1□□36-□□□□	1	1 unit	1CC	5.900
VL630/3VL5	630	0.4 ... 1.0 × I_n	10 × I_n	1.5 ... 9 × I_R	3VL5763-1□□36-□□□□	1	1 unit	1CC	9.300
VL800/3VL6	800	0.4 ... 1.0 × I_n	8 × I_n	1.5 ... 7 × I_R	3VL6780-1□□36-□□□□	1	1 unit	1CC	16.000
VL1250/3VL7	1000	0.4 ... 1.0 × I_n	11 × I_n	1.5 ... 10 × I_R	3VL7710-1□□36-□□□□	1	1 unit	1CC	25.000
	1250	0.4 ... 1.0 × I_n	11 × I_n	1.5 ... 10 × I_R	3VL7712-1□□36-□□□□	1	1 unit	1CC	25.000
VL1600/3VL8 ²⁾	1600	0.4 ... 1.0 × I_n	9 × I_n	1.5 ... 8 × I_R	3VL8716-1□□30-□□□□	1	1 unit	1CC	31.300

- Without communication preparation
- With communication preparation
- Marine engineering-certified LRS, DNV, GL and BV (not communication-ready)

SE
ME
LE

¹⁾ When the circuit breaker with flat screw terminal is ordered, the basic price is reduced.

²⁾ Front busbar connection pieces are included in the scope of supply and are to be fitted by the customer.

Communication:

- For accessories, see page 2/207.
- For more information, see also chapter "Measuring Devices and Power Monitoring" and chapter "Software".

Molded Case Circuit Breakers

3VL Molded Case Circuit Breakers up to 1600 A, IEC

3-pole

2

DT	I_{cu} up to 70 kA at 415 V, high breaking capacity H					(H)	DT	I_{cu} up to 100 kA at 415 V, very high breaking capacity L					(L)
	Article No.	Price	PU (UNIT, SET, M)	PS*/P. unit	PG	Weight per PU approx. kg		Article No.	Price	PU (UNIT, SET, M)	PS*/P. unit	PG	Weight per PU approx. kg

3VL2706-2□□3□-□□□□	1	1 unit	1CC	2.400
3VL2710-2□□3□-□□□□	1	1 unit	1CC	2.400
3VL2716-2□□3□-□□□□	1	1 unit	1CC	2.400
3VL3720-2□□3□-□□□□	1	1 unit	1CC	2.500
3VL3725-2□□3□-□□□□	1	1 unit	1CC	2.500

3VL2706-3□□3□-□□□□	1	1 unit	1CC	2.400
3VL2710-3□□3□-□□□□	1	1 unit	1CC	2.400
3VL2716-3□□3□-□□□□	1	1 unit	1CC	2.400
3VL3720-3□□3□-□□□□	1	1 unit	1CC	2.500
3VL3725-3□□3□-□□□□	1	1 unit	1CC	2.500

3
6

3
6

3VL4731-2□□36-□□□□	1	1 unit	1CC	5.900
3VL4740-2□□36-□□□□	1	1 unit	1CC	5.900
3VL5763-2□□36-□□□□	1	1 unit	1CC	9.300
3VL6780-2□□36-□□□□	1	1 unit	1CC	16.000
3VL7710-2□□36-□□□□	1	1 unit	1CC	25.000
3VL7712-2□□36-□□□□	1	1 unit	1CC	25.000
3VL8716-2□□30-□□□□	1	1 unit	1CC	31.300

3VL4731-3□□36-□□□□	1	1 unit	1CC	5.900
3VL4740-3□□36-□□□□	1	1 unit	1CC	5.900
3VL5763-3□□36-□□□□	1	1 unit	1CC	9.300
3VL6780-3□□36-□□□□	1	1 unit	1CC	16.000
3VL7710-3□□36-□□□□	1	1 unit	1CC	25.000
3VL7712-3□□36-□□□□	1	1 unit	1CC	25.000
3VL8716-3□□30-□□□□	1	1 unit	1CC	31.300

SE
ME
LE

SE
ME
LE

Molded Case Circuit Breakers

3VL Molded Case Circuit Breakers up to 1600 A, IEC

3-pole

2

Type	Rated current I_n	Current setting of the inverse-time delayed overcurrent protection "L" I_R	Operating current of the instantaneous short-circuit protection "I" I_I	S function short-circuit protection (short-time delayed) S	Ground-fault protection "G" I_g	DT	I_{cu} up to 55 kA at 415 V, standard breaking capacity N See "Overview".					(N)
	A	A	A	A	A		Article No. Article No. supplement, see page 2/172; www.siemens.com/product?Article.No.	Price	PU (UNIT, SET, M)	PS*/P. unit	PG	Weight per PU approx. kg

3-pole, fixed-mounted, for line protection – generator protection, 63 A to 1600 A, Electronic Trip Units LSIG

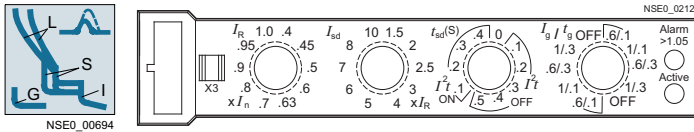

ETU22, LSIG function for 3-wire three-phase systems and time-based discrimination

With adjustable overcurrent releases, non-adjustable short-circuit releases, ground fault delay $t_g = 0.1 \dots 0.3$ s, short-circuit delay $t_{sd} = 0 \dots 0.5$ s, ground-fault protection (G) can be switched off

Type	Rated current I_n	Current setting of the inverse-time delayed overcurrent protection "L" I_R	Operating current of the instantaneous short-circuit protection "I" I_I	S function short-circuit protection (short-time delayed) S	Ground-fault protection "G" I_g	DT	I_{cu} up to 55 kA at 415 V, standard breaking capacity N See "Overview".	Price	PU (UNIT, SET, M)	PS*/P. unit	PG	Weight per PU approx. kg
VL160/3VL2	63	25 ... 63	$11 \times I_n$	$1.5 \dots 10 \times I_R$	$0.6 \dots 1 \times I_n$, OFF		3VL2706-1□□3□-□□□□		1	1 unit	1CC	2,400
	100	40 ... 100	$11 \times I_n$	$1.5 \dots 10 \times I_R$	$0.6 \dots 1 \times I_n$, OFF		3VL2710-1□□3□-□□□□		1	1 unit	1CC	2,400
	160	64 ... 160	$11 \times I_n$	$1.5 \dots 10 \times I_R$	$0.6 \dots 1 \times I_n$, OFF		3VL2716-1□□3□-□□□□		1	1 unit	1CC	2,400
VL250/3VL3	200	80 ... 200	$11 \times I_n$	$1.5 \dots 10 \times I_R$	$0.6 \dots 1 \times I_n$, OFF		3VL3720-1□□3□-□□□□		1	1 unit	1CC	2,500
	250	100 ... 250	$11 \times I_n$	$1.5 \dots 10 \times I_R$	$0.6 \dots 1 \times I_n$, OFF		3VL3725-1□□3□-□□□□		1	1 unit	1CC	2,500

Connection type can be selected by assignment of the 12th position of the Article No.

- Connection with box terminal
- Connection with screw terminal¹⁾

3
6

VL400/3VL4	315	128 ... 315	$11 \times I_n$	$1.5 \dots 10 \times I_R$	$0.6 \dots 1 \times I_n$, OFF		3VL4731-1□□36-□□□□		1	1 unit	1CC	5,900
	400	160 ... 400	$11 \times I_n$	$1.5 \dots 10 \times I_R$	$0.6 \dots 1 \times I_n$, OFF		3VL4740-1□□36-□□□□		1	1 unit	1CC	5,900
VL630/3VL5	630	252 ... 630	$10 \times I_n$	$1.5 \dots 9 \times I_R$	$0.6 \dots 1 \times I_n$, OFF		3VL5763-1□□36-□□□□		1	1 unit	1CC	9,300
VL800/3VL6	800	320 ... 800	$8 \times I_n$	$1.5 \dots 7 \times I_R$	$0.6 \dots 1 \times I_n$, OFF		3VL6780-1□□36-□□□□		1	1 unit	1CC	16,000
VL1250/3VL7	1000	400 ... 1000	$11 \times I_n$	$1.5 \dots 10 \times I_R$	$0.6 \dots 1 \times I_n$, OFF		3VL7710-1□□36-□□□□		1	1 unit	1CC	25,000
	1250	500 ... 1250	$11 \times I_n$	$1.5 \dots 10 \times I_R$	$0.6 \dots 1 \times I_n$, OFF		3VL7712-1□□36-□□□□		1	1 unit	1CC	25,000
VL1600/3VL8 ²⁾	1600	640 ... 1600	$9 \times I_n$	$1.5 \dots 8 \times I_R$	$0.6 \dots 1 \times I_n$, OFF		3VL8716-1□□30-□□□□		1	1 unit	1CC	31,300

- Without communication preparation
- With communication preparation

SG
MG

¹⁾ When the circuit breaker with flat screw terminal is ordered, the basic price is reduced.

²⁾ Front busbar connection pieces are included in the scope of supply and are to be fitted by the customer.

Communication:

- For accessories, see page 2/207.
- For more information, see also chapter "Measuring Devices and Power Monitoring" and chapter "Software".

Molded Case Circuit Breakers

3VL Molded Case Circuit Breakers up to 1600 A, IEC

3-pole

2

DT I_{cu} up to 70 kA at 415 V, high breaking capacity H						DT I_{cu} up to 100 kA at 415 V, very high breaking capacity L					
Article No.	Price	PU (UNIT, SET, M)	PS*/P. unit	PG	Weight per PU approx. kg	Article No.	Price	PU (UNIT, SET, M)	PS*/P. unit	PG	Weight per PU approx. kg

3VL2706-2□□3□-□□□□		1	1 unit	1CC	2.400	3VL2706-3□□3□-□□□□		1	1 unit	1CC	2.400
3VL2710-2□□3□-□□□□		1	1 unit	1CC	2.400	3VL2710-3□□3□-□□□□		1	1 unit	1CC	2.400
3VL2716-2□□3□-□□□□		1	1 unit	1CC	2.400	3VL2716-3□□3□-□□□□		1	1 unit	1CC	2.400
3VL3720-2□□3□-□□□□		1	1 unit	1CC	2.500	3VL3720-3□□3□-□□□□		1	1 unit	1CC	2.500
3VL3725-2□□3□-□□□□		1	1 unit	1CC	2.500	3VL3725-3□□3□-□□□□		1	1 unit	1CC	2.500
3						3					
6						6					
3VL4731-2□□36-□□□□		1	1 unit	1CC	5.900	3VL4731-3□□36-□□□□		1	1 unit	1CC	5.900
3VL4740-2□□36-□□□□		1	1 unit	1CC	5.900	3VL4740-3□□36-□□□□		1	1 unit	1CC	5.900
3VL5763-2□□36-□□□□		1	1 unit	1CC	9.300	3VL5763-3□□36-□□□□		1	1 unit	1CC	9.300
3VL6780-2□□36-□□□□		1	1 unit	1CC	16.000	3VL6780-3□□36-□□□□		1	1 unit	1CC	16.000
3VL7710-2□□36-□□□□		1	1 unit	1CC	25.000	3VL7710-3□□36-□□□□		1	1 unit	1CC	25.000
3VL7712-2□□36-□□□□		1	1 unit	1CC	25.000	3VL7712-3□□36-□□□□		1	1 unit	1CC	25.000
3VL8716-2□□30-□□□□		1	1 unit	1CC	31.300	3VL8716-3□□30-□□□□		1	1 unit	1CC	31.300
SG						SG					
MG						MG					

Molded Case Circuit Breakers

3VL Molded Case Circuit Breakers up to 1600 A, IEC

3-pole

2

Type	Rated current I_n	Current setting of the inverse-time delayed overcurrent protection "L" I_R	Operating current of the instantaneous short-circuit protection "I" I_I	S function short-circuit protection (short-time delayed) S	Ground-fault protection "G" I_g	DT	I_{cu} up to 55 kA at 415 V, standard breaking capacity N See "Overview".	(N)
	A	A	A	A	A		Article No. Article No. supplement, see page 2/172; www.siemens.com/ product?Article No.	Basic price per PU PU (UNIT, SET, M) PS*/P. unit PG Weight per PU approx. kg

3-pole, fixed-mounted, for line protection – generator protection, 63 A to 1600 A, Electronic Trip Units LSIG

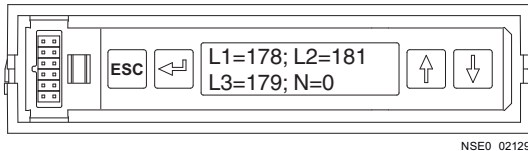
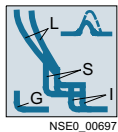

LCD-ETU42, LSIG function for 3-wire three-phase systems and time-based discrimination

With adjustable overcurrent releases, adjustable short-circuit releases
 Vectorial summation current formation, ground fault delay $t_g = 0.1 \dots 0.5$ s, short-circuit delay $t_{sd} = 0 \dots 0.5$ s

VL160/3VL2	63	25 ... 63	$11 \times I_n$	$1.5 \dots 10 \times I_R$	$0.4 \dots 1 \times I_n$	3VL2706-1UL30-□□□□	1	1 unit	1CC	2.400
	100	40 ... 100	$11 \times I_n$	$1.5 \dots 10 \times I_R$	$0.4 \dots 1 \times I_n$	3VL2710-1UL30-□□□□	1	1 unit	1CC	2.400
	160	64 ... 160	$11 \times I_n$	$1.5 \dots 10 \times I_R$	$0.4 \dots 1 \times I_n$	3VL2716-1UL30-□□□□	1	1 unit	1CC	2.400
VL250/3VL3	200	80 ... 200	$11 \times I_n$	$1.5 \dots 10 \times I_R$	$0.4 \dots 1 \times I_n$	3VL3720-1UL30-□□□□	1	1 unit	1CC	2.500
	250	100 ... 250	$11 \times I_n$	$1.5 \dots 10 \times I_R$	$0.4 \dots 1 \times I_n$	3VL3725-1UL30-□□□□	1	1 unit	1CC	2.500

Connection type can be selected by assignment of the 12th position of the Article No.

- Connection with box terminal
- Connection with screw terminal¹⁾

3
6

VL400/3VL4	315	128 ... 315	$11 \times I_n$	$1.5 \dots 10 \times I_R$	$0.4 \dots 1 \times I_n$	3VL4731-1UL36-□□□□	1	1 unit	1CC	5.900
	400	160 ... 400	$11 \times I_n$	$1.5 \dots 10 \times I_R$	$0.4 \dots 1 \times I_n$	3VL4740-1UL36-□□□□	1	1 unit	1CC	5.900
VL630/3VL5	630	252 ... 630	$10 \times I_n$	$1.5 \dots 9 \times I_R$	$0.4 \dots 1 \times I_n$	3VL5763-1UL36-□□□□	1	1 unit	1CC	9.300
VL800/3VL6	800	320 ... 800	$8 \times I_n$	$1.5 \dots 7 \times I_R$	$0.4 \dots 1 \times I_n$	3VL6780-1UL36-□□□□	1	1 unit	1CC	16.000
VL1250/3VL7	1000	400 ... 1000	$11 \times I_n$	$1.5 \dots 10 \times I_R$	$0.4 \dots 1 \times I_n$	3VL7710-1UL36-□□□□	1	1 unit	1CC	25.000
	1250	500 ... 1250	$11 \times I_n$	$1.5 \dots 10 \times I_R$	$0.4 \dots 1 \times I_n$	3VL7712-1UL36-□□□□	1	1 unit	1CC	25.000
VL1600/3VL8 ²⁾	1600	640 ... 1600	$9 \times I_n$	$1.5 \dots 8 \times I_R$	$0.4 \dots 1 \times I_n$	3VL8716-1UL30-□□□□	1	1 unit	1CC	31.300

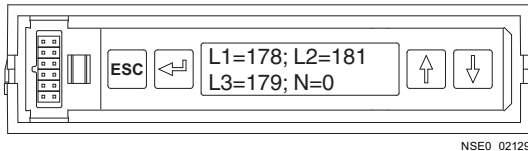
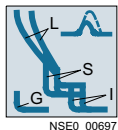

LCD-ETU42, LSIG function for 4-wire three-phase systems and time-based discrimination

With adjustable overcurrent releases, adjustable short-circuit releases. External current transformer required in addition, see page 2/206.
 Vectorial summation current formation, ground fault delay $t_g = 0.1 \dots 0.5$ s, short-circuit delay $t_{sd} = 0 \dots 0.5$ s

VL160/3VL2	63	25 ... 63	$11 \times I_n$	$1.5 \dots 10 \times I_R$	$0.4 \dots 1 \times I_n$	3VL2706-1UM30-□□□□	1	1 unit	1CC	2.400
	100	40 ... 100	$11 \times I_n$	$1.5 \dots 10 \times I_R$	$0.4 \dots 1 \times I_n$	3VL2710-1UM30-□□□□	1	1 unit	1CC	2.400
	160	64 ... 160	$11 \times I_n$	$1.5 \dots 10 \times I_R$	$0.4 \dots 1 \times I_n$	3VL2716-1UM30-□□□□	1	1 unit	1CC	2.400
VL250/3VL3	200	80 ... 200	$11 \times I_n$	$1.5 \dots 10 \times I_R$	$0.4 \dots 1 \times I_n$	3VL3720-1UM30-□□□□	1	1 unit	1CC	2.500
	250	100 ... 250	$11 \times I_n$	$1.5 \dots 10 \times I_R$	$0.4 \dots 1 \times I_n$	3VL3725-1UM30-□□□□	1	1 unit	1CC	2.500

Connection type can be selected by assignment of the 12th position of the Article No.

- Connection with box terminal
- Connection with screw terminal¹⁾

3
6

VL400/3VL4	315	128 ... 315	$11 \times I_n$	$1.5 \dots 10 \times I_R$	$0.4 \dots 1 \times I_n$	3VL4731-1UM36-□□□□	1	1 unit	1CC	5.900
	400	160 ... 400	$11 \times I_n$	$1.5 \dots 10 \times I_R$	$0.4 \dots 1 \times I_n$	3VL4740-1UM36-□□□□	1	1 unit	1CC	5.900
VL630/3VL5	630	252 ... 630	$10 \times I_n$	$1.5 \dots 9 \times I_R$	$0.4 \dots 1 \times I_n$	3VL5763-1UM36-□□□□	1	1 unit	1CC	9.300
VL800/3VL6	800	320 ... 800	$8 \times I_n$	$1.5 \dots 7 \times I_R$	$0.4 \dots 1 \times I_n$	3VL6780-1UM36-□□□□	1	1 unit	1CC	16.000
VL1250/3VL7	1000	400 ... 1000	$11 \times I_n$	$1.5 \dots 10 \times I_R$	$0.4 \dots 1 \times I_n$	3VL7710-1UM36-□□□□	1	1 unit	1CC	25.000
	1250	500 ... 1250	$11 \times I_n$	$1.5 \dots 10 \times I_R$	$0.4 \dots 1 \times I_n$	3VL7712-1UM36-□□□□	1	1 unit	1CC	25.000
VL1600/3VL8 ²⁾	1600	640 ... 1600	$9 \times I_n$	$1.5 \dots 8 \times I_R$	$0.4 \dots 1 \times I_n$	3VL8716-1UM30-□□□□	1	1 unit	1CC	31.300

¹⁾ When the circuit breaker with flat screw terminal is ordered, the basic price is reduced.

²⁾ Front busbar connection pieces are included in the scope of supply and are to be fitted by the customer.

Molded Case Circuit Breakers

3VL Molded Case Circuit Breakers up to 1600 A, IEC

3-pole

2

DT	I_{cu} up to 70 kA at 415 V, high breaking capacity H					(H)	DT	I_{cu} up to 100 kA at 415 V, very high breaking capacity L					(L)
Article No.	Basic price per PU	PU (UNIT, SET, M)	PS*/P. unit	PG	Weight per PU approx.		Article No.	Basic price per PU	PU (UNIT, SET, M)	PS*/P. unit	PG	Weight per PU approx.	
Article No. supplement, see page 2/172; www.siemens.com/product?Article.No.						kg	Article No. supplement, see page 2/172; www.siemens.com/product?Article.No.						kg

3VL2706-2UL3□-□□□□	1	1 unit	1CC	2.400		3VL2706-3UL3□-□□□□	1	1 unit	1CC	2.400	
3VL2710-2UL3□-□□□□	1	1 unit	1CC	2.400		3VL2710-3UL3□-□□□□	1	1 unit	1CC	2.400	
3VL2716-2UL3□-□□□□	1	1 unit	1CC	2.400		3VL2716-3UL3□-□□□□	1	1 unit	1CC	2.400	
3VL3720-2UL3□-□□□□	1	1 unit	1CC	2.500		3VL3720-3UL3□-□□□□	1	1 unit	1CC	2.500	
3VL3725-2UL3□-□□□□	1	1 unit	1CC	2.500		3VL3725-3UL3□-□□□□	1	1 unit	1CC	2.500	

3
6

3
6

3VL4731-2UL36-□□□□	1	1 unit	1CC	5.900		3VL4731-3UL36-□□□□	1	1 unit	1CC	5.900	
3VL4740-2UL36-□□□□	1	1 unit	1CC	5.900		3VL4740-3UL36-□□□□	1	1 unit	1CC	5.900	
3VL5763-2UL36-□□□□	1	1 unit	1CC	9.300		3VL5763-3UL36-□□□□	1	1 unit	1CC	9.300	
3VL6780-2UL36-□□□□	1	1 unit	1CC	16.000		3VL6780-3UL36-□□□□	1	1 unit	1CC	16.000	
3VL7710-2UL36-□□□□	1	1 unit	1CC	25.000		3VL7710-3UL36-□□□□	1	1 unit	1CC	25.000	
3VL7712-2UL36-□□□□	1	1 unit	1CC	25.000		3VL7712-3UL36-□□□□	1	1 unit	1CC	25.000	
3VL8716-2UL30-□□□□	1	1 unit	1CC	31.300		3VL8716-3UL30-□□□□	1	1 unit	1CC	31.300	

3VL2706-2UM3□-□□□□	1	1 unit	1CC	2.400		3VL2706-3UM3□-□□□□	1	1 unit	1CC	2.400	
3VL2710-2UM3□-□□□□	1	1 unit	1CC	2.400		3VL2710-3UM3□-□□□□	1	1 unit	1CC	2.400	
3VL2716-2UM3□-□□□□	1	1 unit	1CC	2.400		3VL2716-3UM3□-□□□□	1	1 unit	1CC	2.400	
3VL3720-2UM3□-□□□□	1	1 unit	1CC	2.500		3VL3720-3UM3□-□□□□	1	1 unit	1CC	2.500	
3VL3725-2UM3□-□□□□	1	1 unit	1CC	2.500		3VL3725-3UM3□-□□□□	1	1 unit	1CC	2.500	

3
6

3
6

3VL4731-2UM36-□□□□	1	1 unit	1CC	5.900		3VL4731-3UM36-□□□□	1	1 unit	1CC	5.900	
3VL4740-2UM36-□□□□	1	1 unit	1CC	5.900		3VL4740-3UM36-□□□□	1	1 unit	1CC	5.900	
3VL5763-2UM36-□□□□	1	1 unit	1CC	9.300		3VL5763-3UM36-□□□□	1	1 unit	1CC	9.300	
3VL6780-2UM36-□□□□	1	1 unit	1CC	16.000		3VL6780-3UM36-□□□□	1	1 unit	1CC	16.000	
3VL7710-2UM36-□□□□	1	1 unit	1CC	25.000		3VL7710-3UM36-□□□□	1	1 unit	1CC	25.000	
3VL7712-2UM36-□□□□	1	1 unit	1CC	25.000		3VL7712-3UM36-□□□□	1	1 unit	1CC	25.000	
3VL8716-2UM30-□□□□	1	1 unit	1CC	31.300		3VL8716-3UM30-□□□□	1	1 unit	1CC	31.300	

Molded Case Circuit Breakers

3VL Molded Case Circuit Breakers up to 1600 A, IEC

3-pole

2

Type	Rated current I_n	Current setting of the inverse-time delayed overcurrent protection "L" I_R	Operating current of the instantaneous short-circuit protection "I" I_I	S function short-circuit protection (short-time delayed) S	Ground-fault protection "G" I_g	DT	I_{cu} up to 55 kA at 415 V, standard breaking capacity N See "Overview".	(N)				
	A	A	A	A	A		Article No. Article No. supplement, see page 2/172; www.siemens.com/product?Article.No.	Price	PU (UNIT, SET, M)	PS*/P. unit	PG	Weight per PU approx. kg

3-pole, fixed-mounted, for line protection – generator protection, 63 A to 1600 A, Electronic Trip Units LSIG

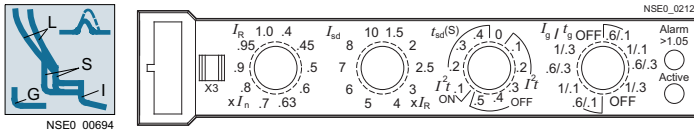

ETU22, LSIG function for 4-wire three-phase systems and time-based discrimination

With adjustable overcurrent releases, non-adjustable short-circuit releases, external current transformers required in addition, see page 2/206. Ground fault delay $t_g = 0.1 \dots 0.3$ s, short-circuit delay $t_{sd} = 0 \dots 0.5$ s, ground-fault protection (G) can be switched off

VL160/3VL2	63	25 ... 63	$11 \times I_n$	$1.5 \dots 10 \times I_R$	$0.6 \dots 1 \times I_n$	OFF	3VL2706-1□□3□-□□□□	1	1 unit	1CC	2.400
	100	40 ... 100	$11 \times I_n$	$1.5 \dots 10 \times I_R$	$0.6 \dots 1 \times I_n$	OFF	3VL2710-1□□3□-□□□□	1	1 unit	1CC	2.400
	160	64 ... 160	$11 \times I_n$	$1.5 \dots 10 \times I_R$	$0.6 \dots 1 \times I_n$	OFF	3VL2716-1□□3□-□□□□	1	1 unit	1CC	2.400
VL250/3VL3	200	80 ... 200	$11 \times I_n$	$1.5 \dots 10 \times I_R$	$0.6 \dots 1 \times I_n$	OFF	3VL3720-1□□3□-□□□□	1	1 unit	1CC	2.500
	250	100 ... 250	$11 \times I_n$	$1.5 \dots 10 \times I_R$	$0.6 \dots 1 \times I_n$	OFF	3VL3725-1□□3□-□□□□	1	1 unit	1CC	2.500

Connection type can be selected by assignment of the 12th position of the Article No.

- Connection with box terminal
- Connection with screw terminal¹⁾

3
6

VL400/3VL4	315	128 ... 315	$11 \times I_n$	$1.5 \dots 10 \times I_R$	$0.6 \dots 1 \times I_n$	OFF	3VL4731-1□□36-□□□□	1	1 unit	1CC	5.900
	400	160 ... 400	$11 \times I_n$	$1.5 \dots 10 \times I_R$	$0.6 \dots 1 \times I_n$	OFF	3VL4740-1□□36-□□□□	1	1 unit	1CC	5.900
VL630/3VL5	630	252 ... 630	$10 \times I_n$	$1.5 \dots 9 \times I_R$	$0.6 \dots 1 \times I_n$	OFF	3VL5763-1□□36-□□□□	1	1 unit	1CC	9.300
VL800/3VL6	800	320 ... 800	$8 \times I_n$	$1.5 \dots 7 \times I_R$	$0.6 \dots 1 \times I_n$	OFF	3VL6780-1□□36-□□□□	1	1 unit	1CC	16.000
VL1250/3VL7	1000	400 ... 1000	$11 \times I_n$	$1.5 \dots 10 \times I_R$	$0.6 \dots 1 \times I_n$	OFF	3VL7710-1□□36-□□□□	1	1 unit	1CC	25.000
	1250	500 ... 1250	$11 \times I_n$	$1.5 \dots 10 \times I_R$	$0.6 \dots 1 \times I_n$	OFF	3VL7712-1□□36-□□□□	1	1 unit	1CC	25.000
VL1600/3VL8 ²⁾	1600	640 ... 1600	$9 \times I_n$	$1.5 \dots 8 \times I_R$	$0.6 \dots 1 \times I_n$	OFF	3VL8716-1□□30-□□□□	1	1 unit	1CC	31.300

- Without communication preparation
- With communication preparation

SH
MH

¹⁾ When the circuit breaker with flat screw terminal is ordered, the basic price is reduced.

²⁾ Front busbar connection pieces are included in the scope of supply and are to be fitted by the customer.

Communication:

- For accessories, see page 2/207.
- For more information, see also chapter "Measuring Devices and Power Monitoring" and chapter "Software".

Molded Case Circuit Breakers

3VL Molded Case Circuit Breakers up to 1600 A, IEC

3-pole

2

DT I_{cu} up to 70 kA at 415 V, high breaking capacity H						DT I_{cu} up to 100 kA at 415 V, very high breaking capacity L					
Article No.	Price	PU (UNIT, SET, M)	PS*/P. unit	PG	Weight per PU approx. kg	Article No.	Price	PU (UNIT, SET, M)	PS*/P. unit	PG	Weight per PU approx. kg
B 3VL2706-2□□3□-□□□□		1	1 unit	1CC	2.400	B 3VL2706-3□□3□-□□□□		1	1 unit	1CC	2.400
B 3VL2710-2□□3□-□□□□		1	1 unit	1CC	2.400	B 3VL2710-3□□3□-□□□□		1	1 unit	1CC	2.400
B 3VL2716-2□□3□-□□□□		1	1 unit	1CC	2.400	B 3VL2716-3□□3□-□□□□		1	1 unit	1CC	2.400
B 3VL3720-2□□3□-□□□□		1	1 unit	1CC	2.500	B 3VL3720-3□□3□-□□□□		1	1 unit	1CC	2.500
B 3VL3725-2□□3□-□□□□		1	1 unit	1CC	2.500	B 3VL3725-3□□3□-□□□□		1	1 unit	1CC	2.500
3						3					
6						6					
B 3VL4731-2□□36-□□□□		1	1 unit	1CC	5.900	B 3VL4731-3□□36-□□□□		1	1 unit	1CC	5.900
B 3VL4740-2□□36-□□□□		1	1 unit	1CC	5.900	B 3VL4740-3□□36-□□□□		1	1 unit	1CC	5.900
B 3VL5763-2□□36-□□□□		1	1 unit	1CC	9.300	B 3VL5763-3□□36-□□□□		1	1 unit	1CC	9.300
B 3VL6780-2□□36-□□□□		1	1 unit	1CC	16.000	B 3VL6780-3□□36-□□□□		1	1 unit	1CC	16.000
B 3VL7710-2□□36-□□□□		1	1 unit	1CC	25.000	B 3VL7710-3□□36-□□□□		1	1 unit	1CC	25.000
B 3VL7712-2□□36-□□□□		1	1 unit	1CC	25.000	B 3VL7712-3□□36-□□□□		1	1 unit	1CC	25.000
B 3VL8716-2□□30-□□□□		1	1 unit	1CC	31.300	B 3VL8716-3□□30-□□□□		1	1 unit	1CC	31.300
SH						SH					
MH						MH					

Molded Case Circuit Breakers

3VL Molded Case Circuit Breakers up to 1600 A, IEC

3-pole

2

Type	Rated current I_n	Current setting of the inverse-time delayed overcurrent protection "L" I_R	Operating current of the instantaneous short-circuit protection "I" I_i	S function short-circuit protection (short-time delayed) S	DT	I_{cu} up to 55 kA at 415 V, standard breaking capacity N See "Overview".					
	A	A	A	A		Article No. Article No. supplement, see page 2/172; www.siemens.com/product?Article.No.	Basic price per PU	PU (UNIT, SET, M)	PS*/P. unit	PG	Weight per PU approx. kg

3-pole, fixed-mounted, for line protection – generator protection, 63 A to 1600 A, Electronic Trip Units LI, LS, LSI

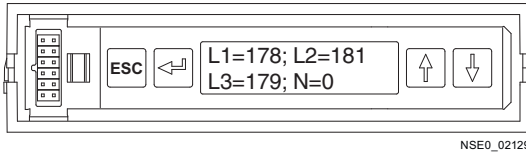
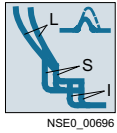

LCD-ETU40, LI/LS/LSI function selectable

With adjustable overcurrent releases, adjustable short-circuit releases, short-circuit delay ($t_{sd} = 0$ to 0.5 s)

VL160/3VL2	63	25 ... 63	1.25 ... 11 × I_n	1.5 ... 10 × I_R	3VL2706-1UH3□-□□□□	1	1 unit	1CC	2.400
	100	40 ... 100	1.25 ... 11 × I_n	1.5 ... 10 × I_R	3VL2710-1UH3□-□□□□	1	1 unit	1CC	2.400
	160	64 ... 160	1.25 ... 11 × I_n	1.5 ... 10 × I_R	3VL2716-1UH3□-□□□□	1	1 unit	1CC	2.400
VL250/3VL3	200	80 ... 200	1.25 ... 11 × I_n	1.5 ... 10 × I_R	3VL3720-1UH3□-□□□□	1	1 unit	1CC	2.500
	250	100 ... 250	1.25 ... 11 × I_n	1.5 ... 10 × I_R	3VL3725-1UH3□-□□□□	1	1 unit	1CC	2.500

Connection type can be selected by assignment of the 12th position of the Article No.

- Connection with box terminal
- Connection with screw terminal¹⁾

3
6

VL400/3VL4	315	128 ... 315	1.25 ... 11 × I_n	1.5 ... 10 × I_R	3VL4731-1UH36-□□□□	1	1 unit	1CC	5.900
	400	160 ... 400	1.25 ... 11 × I_n	1.5 ... 10 × I_R	3VL4740-1UH36-□□□□	1	1 unit	1CC	5.900
VL630/3VL5	630	252 ... 630	1.25 ... 10 × I_n	1.5 ... 9 × I_R	3VL5763-1UH36-□□□□	1	1 unit	1CC	9.300
VL800/3VL6	800	320 ... 800	1.25 ... 8 × I_n	1.5 ... 7 × I_R	3VL6780-1UH36-□□□□	1	1 unit	1CC	16.000
VL1250/3VL7	1000	400 ... 1000	1.25 ... 11 × I_n	1.5 ... 10 × I_R	3VL7710-1UH36-□□□□	1	1 unit	1CC	25.000
	1250	500 ... 1250	1.25 ... 11 × I_n	1.5 ... 10 × I_R	3VL7712-1UH36-□□□□	1	1 unit	1CC	25.000
VL1600/3VL8 ²⁾	1600	640 ... 1600	1.25 ... 9 × I_n	1.5 ... 8 × I_R	3VL8716-1UH30-□□□□	1	1 unit	1CC	31.300

¹⁾ When the circuit breaker with flat screw terminal is ordered, the basic price is reduced.

²⁾ Front busbar connection pieces are included in the scope of supply and are to be fitted by the customer.

Molded Case Circuit Breakers

3VL Molded Case Circuit Breakers up to 1600 A, IEC

3-pole

2

DT I_{cu} up to 70 kA at 415 V, high breaking capacity H						DT I_{cu} up to 100 kA at 415 V, very high breaking capacity L					
(H)						(L)					
Article No.	Basic price per PU	PU (UNIT, SET, M)	PS*/P. unit	PG	Weight per PU approx. kg	Article No.	Basic price per PU	PU (UNIT, SET, M)	PS*/P. unit	PG	Weight per PU approx. kg
3VL2706-2UH3□-□□□□		1	1 unit	1CC	2.400	3VL2706-3UH3□-□□□□		1	1 unit	1CC	2.400
3VL2710-2UH3□-□□□□		1	1 unit	1CC	2.400	3VL2710-3UH3□-□□□□		1	1 unit	1CC	2.400
3VL2716-2UH3□-□□□□		1	1 unit	1CC	2.400	3VL2716-3UH3□-□□□□		1	1 unit	1CC	2.400
3VL3720-2UH3□-□□□□		1	1 unit	1CC	2.500	3VL3720-3UH3□-□□□□		1	1 unit	1CC	2.500
3VL3725-2UH3□-□□□□		1	1 unit	1CC	2.500	3VL3725-3UH3□-□□□□		1	1 unit	1CC	2.500
3						3					
6						6					
3VL4731-2UH36-□□□□		1	1 unit	1CC	5.900	3VL4731-3UH36-□□□□		1	1 unit	1CC	5.900
3VL4740-2UH36-□□□□		1	1 unit	1CC	5.900	3VL4740-3UH36-□□□□		1	1 unit	1CC	5.900
3VL5763-2UH36-□□□□		1	1 unit	1CC	9.300	3VL5763-3UH36-□□□□		1	1 unit	1CC	9.300
3VL6780-2UH36-□□□□		1	1 unit	1CC	16.000	3VL6780-3UH36-□□□□		1	1 unit	1CC	16.000
3VL7710-2UH36-□□□□		1	1 unit	1CC	25.000	3VL7710-3UH36-□□□□		1	1 unit	1CC	25.000
3VL7712-2UH36-□□□□		1	1 unit	1CC	25.000	3VL7712-3UH36-□□□□		1	1 unit	1CC	25.000
3VL8716-2UH30-□□□□		1	1 unit	1CC	31.300	3VL8716-3UH30-□□□□		1	1 unit	1CC	31.300

Molded Case Circuit Breakers

3VL Molded Case Circuit Breakers up to 1600 A, IEC

3-pole

2

Type	Rated current I_n	Current setting of the inverse-time delayed overcurrent releases "L" I_R	Operating current of the instantaneous short-circuit protection "I" I_i	DT	I_{cu} up to 55 kA at 415 V, standard breaking capacity N See "Overview".	Price	PU (UNIT, SET, M)	PS*/P. unit	PG	Weight per PU approx.
	A	A	A		Article No. Article No. supplement, see page 2/172; www.siemens.com/product?ArticleNo.					kg

3-pole, fixed-mounted, for motor protection, 63 A to 500 A, Electronic Trip Units LI

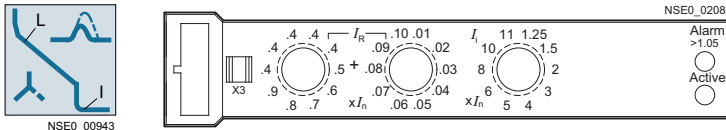

ETU10M, LI function¹⁾

With thermal image, with non-adjustable trip class $t_C = 10$, with phase failure sensitivity 40 % I_R

VL160/3VL2	63	25 ... 63	1.25 ... 11 × I_n	3VL2706-1□□3□-□□□□	1	1 unit	1CC	2.400
	100	40 ... 100	1.25 ... 11 × I_n	3VL2710-1□□3□-□□□□	1	1 unit	1CC	2.400
	160	64 ... 160	1.25 ... 11 × I_n	3VL2716-1□□3□-□□□□	1	1 unit	1CC	2.400
VL250/3VL3	200	80 ... 200	1.25 ... 11 × I_n	3VL3720-1□□3□-□□□□	1	1 unit	1CC	2.500
	250	100 ... 250	1.25 ... 11 × I_n	3VL3725-1□□3□-□□□□	1	1 unit	1CC	2.500

Connection type can be selected by assignment of the 12th position of the Article No.

- Connection with box terminal
- Connection with screw terminal⁽²⁾

3
6

VL400/3VL4	315	125 ... 315	1.25 ... 11 × I_n	3VL4731-1□□36-□□□□	1	1 unit	1CC	5.900
VL630/3VL5	500	200 ... 500	1.25 ... 12.5 × I_n	3VL5750-1□□36-□□□□	1	1 unit	1CC	9.300

- Without communication preparation
- With communication preparation

SP
MP

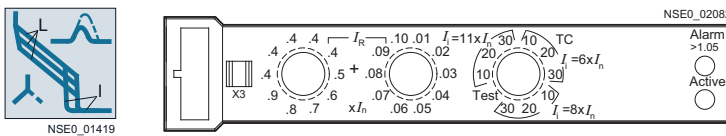

ETU30M, LI function¹⁾

With thermal image, with adjustable trip class $t_C = 10, 20, 30$, with phase failure sensitivity 40 % I_R

VL160/3VL2	63	25 ... 63	6/8/11 × I_n	3VL2706-1□□3□-□□□□	1	1 unit	1CC	2.400
	100	40 ... 100	6/8/11 × I_n	3VL2710-1□□3□-□□□□	1	1 unit	1CC	2.400
	160	64 ... 160	6/8/11 × I_n	3VL2716-1□□3□-□□□□	1	1 unit	1CC	2.400
VL250/3VL3	200	80 ... 200	6/8/11 × I_n	3VL3720-1□□3□-□□□□	1	1 unit	1CC	2.500
	250	100 ... 250	6/8/11 × I_n	3VL3725-1□□3□-□□□□	1	1 unit	1CC	2.500

Connection type can be selected by assignment of the 12th position of the Article No.

- Connection with box terminal
- Connection with screw terminal⁽²⁾

3
6

VL400/3VL4	315	125 ... 315	6/8/11 × I_n	3VL4731-1□□36-□□□□	1	1 unit	1CC	5.900
VL630/3VL5	500	200 ... 500	6/8/12.5 × I_n	3VL5750-1□□36-□□□□	1	1 unit	1CC	9.300

- Without communication preparation
- With communication preparation
- Marine engineering-certified LRS, DNV, GL and BV (not communication-ready)

SS
MS
LS

Communication:

- For accessories, see page 2/207.
- For more information, see also chapter "Measuring Devices and Power Monitoring" and chapter "Software".

- For use of 3VL molded case circuit breakers with an energy-efficient IE3 motor, you are advised to use a contactor for operational switching of the motor; see also page 2/13.
- When the circuit breaker with flat screw terminal is ordered, the basic price is reduced.

Molded Case Circuit Breakers

3VL Molded Case Circuit Breakers up to 1600 A, IEC

3-pole

2

DT I_{cu} up to 70 kA at 415 V, high breaking capacity H						DT I_{cu} up to 100 kA at 415 V, very high breaking capacity L					
Article No.	Price	PU (UNIT, SET, M)	PS* / P. unit	PG	Weight per PU approx. kg	Article No.	Price	PU (UNIT, SET, M)	PS* / P. unit	PG	Weight per PU approx. kg

3VL2706-2□□3□-□□□□	1	1 unit	1CC	2.400
3VL2710-2□□3□-□□□□	1	1 unit	1CC	2.400
3VL2716-2□□3□-□□□□	1	1 unit	1CC	2.400
3VL3720-2□□3□-□□□□	1	1 unit	1CC	2.500
3VL3725-2□□3□-□□□□	1	1 unit	1CC	2.500

3VL2706-3□□3□-□□□□	1	1 unit	1CC	2.400
3VL2710-3□□3□-□□□□	1	1 unit	1CC	2.400
3VL2716-3□□3□-□□□□	1	1 unit	1CC	2.400
3VL3720-3□□3□-□□□□	1	1 unit	1CC	2.500
3VL3725-3□□3□-□□□□	1	1 unit	1CC	2.500

3
6

3
6

3VL4731-2□□36-□□□□	1	1 unit	1CC	5.900
3VL5750-2□□36-□□□□	1	1 unit	1CC	9.300

3VL4731-3□□36-□□□□	1	1 unit	1CC	5.900
3VL5750-3□□36-□□□□	1	1 unit	1CC	9.300

SP
MP

SP
MP

3VL2706-2□□3□-□□□□	1	1 unit	1CC	2.400
3VL2710-2□□3□-□□□□	1	1 unit	1CC	2.400
3VL2716-2□□3□-□□□□	1	1 unit	1CC	2.400
3VL3720-2□□3□-□□□□	1	1 unit	1CC	2.500
3VL3725-2□□3□-□□□□	1	1 unit	1CC	2.500

3VL2706-3□□3□-□□□□	1	1 unit	1CC	2.400
3VL2710-3□□3□-□□□□	1	1 unit	1CC	2.400
3VL2716-3□□3□-□□□□	1	1 unit	1CC	2.400
3VL3720-3□□3□-□□□□	1	1 unit	1CC	2.500
3VL3725-3□□3□-□□□□	1	1 unit	1CC	2.500

3
6

3
6

3VL4731-2□□36-□□□□	1	1 unit	1CC	5.900
3VL5750-2□□36-□□□□	1	1 unit	1CC	9.300

3VL4731-3□□36-□□□□	1	1 unit	1CC	5.900
3VL5750-3□□36-□□□□	1	1 unit	1CC	9.300

SS
MS
LS

SS
MS
LS

Molded Case Circuit Breakers

3VL Molded Case Circuit Breakers up to 1600 A, IEC

3-pole

2

Type	Rated current I_n	Current setting of the inverse-time delayed overcurrent protection "L" I_R	Operating current of the instantaneous short-circuit protection "I" I_i	DT	I_{cu} up to 55 kA at 415 V, standard breaking capacity N See "Overview".	(N)
	A	A	A		Article No. Article No. supplement, see page 2/172; www.siemens.com/product?ArticleNo.	Basic price per PU PU (UNIT, SET, M) PS*/P. unit PG Weight per PU approx. kg

3-pole, fixed-mounted, for motor protection, 63 A to 500 A, Electronic Trip Units LI

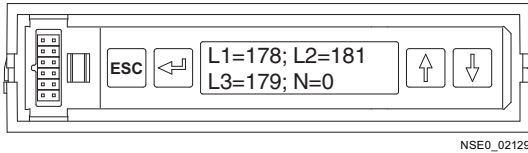
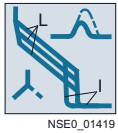

LCD-ETU40M, LI function¹⁾

With thermal image, with adjustable trip class $I_C = 5, 10, 15, 20, 30$, phase failure sensitivity adjustable in steps 5 ... 50 % I_R

VL160/3VL2	63 100 160	25 ... 63 40 ... 100 64 ... 160	$1.25 \dots 11 \times I_n$ $1.25 \dots 11 \times I_n$ $1.25 \dots 11 \times I_n$	3VL2706-1UP3□-□□□□ 3VL2710-1UP3□-□□□□ 3VL2716-1UP3□-□□□□	1 1 1	1 unit 1 unit 1 unit	1CC 1CC 1CC	2.400 2.400 2.400
VL250/3VL3	200 250	80 ... 200 100 ... 250	$1.25 \dots 11 \times I_n$ $1.25 \dots 11 \times I_n$	3VL3720-1UP3□-□□□□ 3VL3725-1UP3□-□□□□	1 1	1 unit 1 unit	1CC 1CC	2.500 2.500

Connection type can be selected by assignment of the 12th position of the Article No.

- Connection with box terminal
- Connection with screw terminal²⁾

3
6

VL400/3VL4	315	128 ... 315	$1.25 \dots 11 \times I_n$	3VL4731-1UP36-□□□□	1	1 unit	1CC	5.900
VL630/3VL5	500	250 ... 500	$1.25 \dots 12.5 \times I_n$	3VL5750-1UP36-□□□□	1	1 unit	1CC	9.300

¹⁾ For use of 3VL molded case circuit breakers with an energy-efficient IE3 motor, you are advised to use a contactor for operational switching of the motor; see also page 2/13.

²⁾ When the circuit breaker with flat screw terminal is ordered, the basic price is reduced.

Molded Case Circuit Breakers

3VL Molded Case Circuit Breakers up to 1600 A, IEC

3-pole

2

DT I_{cu} up to 70 kA at 415 V, high breaking capacity H						DT I_{cu} up to 100 kA at 415 V, very high breaking capacity L					
Article No.	Basic price per PU	PU (UNIT, SET, M)	PS* / P. unit	PG	Weight per PU approx. kg	Article No.	Basic price per PU	PU (UNIT, SET, M)	PS* / P. unit	PG	Weight per PU approx. kg
3VL2706-2UP3□-□□□□		1	1 unit	1CC	2.400	3VL2706-3UP3□-□□□□		1	1 unit	1CC	2.400
3VL2710-2UP3□-□□□□		1	1 unit	1CC	2.400	3VL2710-3UP3□-□□□□		1	1 unit	1CC	2.400
3VL2716-2UP3□-□□□□		1	1 unit	1CC	2.400	3VL2716-3UP3□-□□□□		1	1 unit	1CC	2.400
3VL3720-2UP3□-□□□□		1	1 unit	1CC	2.500	3VL3720-3UP3□-□□□□		1	1 unit	1CC	2.500
3VL3725-2UP3□-□□□□		1	1 unit	1CC	2.500	3VL3725-3UP3□-□□□□		1	1 unit	1CC	2.500
<div style="display: flex; justify-content: space-around; width: 100%;"> 3 3 </div> <div style="display: flex; justify-content: space-around; width: 100%;"> 6 6 </div>											
3VL4731-2UP36-□□□□		1	1 unit	1CC	5.900	3VL4731-3UP36-□□□□		1	1 unit	1CC	5.900
3VL5750-2UP36-□□□□		1	1 unit	1CC	9.300	3VL5750-3UP36-□□□□		1	1 unit	1CC	9.300

* You can order this quantity or a multiple thereof.

Molded Case Circuit Breakers

3VL Molded Case Circuit Breakers up to 1600 A, IEC

3-pole

2

Type	Rated current I_n	Operating current of the instantaneous short-circuit releases I_i	DT	I_{cu} up to 55 kA at 415 V, standard breaking capacity N See 'Overview'.	(N)
	A			Article No. Article No. supplement, see page 2/172; www.siemens.com/product?ArticleNo .	Basic price per PU PU (UNIT, SET, M) PS*/P: unit PG Weight per PU approx. kg

3-pole, fixed-mounted, for starter protection, 63 A to 500 A, magnetic trip unit I

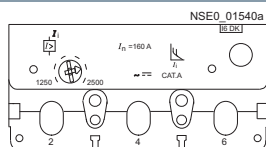

Starter protection, M, I function¹⁾

Without thermal overcurrent release, with adjustable short-circuit release

VL160/3VL2	63 100 160	450 ... 900 750 ... 1500 1250 ... 2500	3VL2706-1DK3□-□□□□ 3VL2710-1DK3□-□□□□ 3VL2716-1DK3□-□□□□	1 1 1	1 unit 1 unit 1 unit	1CC 1CC 1CC	2,200 2,200 2,200
VL250/3VL3	250	1750 ... 3500	3VL3725-1DK3□-□□□□	1	1 unit	1CC	2,300

Connection type can be selected by assignment of the 12th position of the Article No.

- Connection with box terminal
- Connection with screw terminal²⁾

3
6

VL400/3VL4	200 250 315	1250 ... 2500 2000 ... 4000 2000 ... 4000	3VL4720-1DK36-□□□□ 3VL4725-1DK36-□□□□ 3VL4731-1DK36-□□□□	1 1 1	1 unit 1 unit 1 unit	1CC 1CC 1CC	5,700 5,700 5,700
VL630/3VL5	315 500	2000 ... 4000 3250 ... 6300	3VL5731-1DK36-□□□□ 3VL5750-1DK36-□□□□	1 1	1 unit 1 unit	1CC 1CC	9,000 9,000

3-pole, fixed-mounted, for safe disconnection, 100 A to 1600 A, magnetic trip unit I

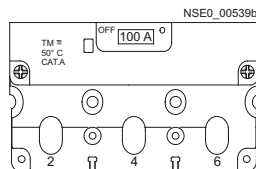

Non-automatic molded case circuit breakers³⁾, I function

Without thermal overcurrent release, with non-adjustable short-circuit release (for intrinsic protection only)

VL160X/3VL1	100 160	1800 1800	3VL1710-1DE3□-□□□□ 3VL1716-1DE3□-□□□□	1 1	1 unit 1 unit	1CC 1CC	2,000 2,000
VL160/3VL2	100 160	2500 2500	3VL2710-1DE3□-□□□□ 3VL2716-1DE3□-□□□□	1 1	1 unit 1 unit	1CC 1CC	2,200 2,200
VL250/3VL3	250	3500	3VL3725-1DE3□-□□□□	1	1 unit	1CC	2,300

Connection type can be selected by assignment of the 12th position of the Article No.

- Connection with box terminal
- Connection with screw terminal not in conjunction with RCD module at 3VL1²⁾

3
6

VL400/3VL4	400	4000	3VL4740-1DE36-□□□□	1	1 unit	1CC	5,700
VL630/3VL5	630	6300	3VL5763-1DE36-□□□□	1	1 unit	1CC	9,000
VL800/3VL6	800	6500	3VL6780-1DE36-□□□□	1	1 unit	1CC	15,700
VL1250/3VL7	1250	12000	3VL7712-1DE36-□□□□	1	1 unit	1CC	23,500
VL1600/3VL8 ⁴⁾	1600	14400	3VL8716-1DE30-□□□□	1	1 unit	1CC	29,800

For further versions, including for short-circuit and ground fault protection, see pages 2/128 to 2/144.

- For use of 3VL molded case circuit breakers with an energy-efficient IE3 motor, you are advised to use a contactor for operational switching of the motor; see also page 2/122.
- When the circuit breaker with flat screw terminal is ordered, the basic price is reduced.
- See chapter "Switch Disconnectors". 3K. switch disconnectors are also available with rear-mounting operating mechanism and leading contacts.
- Front busbar connection pieces are included in the scope of supply and are to be fitted by the customer.

Molded Case Circuit Breakers

3VL Molded Case Circuit Breakers up to 1600 A, IEC

3-pole

2

DT I_{cu} up to 70 kA at 415 V, high breaking capacity H						(H)	DT I_{cu} up to 100 kA at 415 V, very high breaking capacity L						(L)
Article No.	Basic price per PU	PU (UNIT, SET, M)	PS*/P. unit	PG	Weight per PU approx. kg		Article No.	Basic price per PU	PU (UNIT, SET, M)	PS*/P. unit	PG	Weight per PU approx. kg	
3VL2706-2DK3□-□□□□		1	1 unit	1CC	2.200		3VL2706-3DK3□-□□□□		1	1 unit	1CC	2.200	
3VL2710-2DK3□-□□□□		1	1 unit	1CC	2.200		3VL2710-3DK3□-□□□□		1	1 unit	1CC	2.200	
3VL2716-2DK3□-□□□□		1	1 unit	1CC	2.200		3VL2716-3DK3□-□□□□		1	1 unit	1CC	2.200	
3VL3725-2DK3□-□□□□		1	1 unit	1CC	2.300		3VL3725-3DK3□-□□□□		1	1 unit	1CC	2.300	
3							3						
6							6						
3VL4720-2DK36-□□□□		1	1 unit	1CC	5.700		3VL4720-3DK36-□□□□		1	1 unit	1CC	5.700	
3VL4725-2DK36-□□□□		1	1 unit	1CC	5.700		3VL4725-3DK36-□□□□		1	1 unit	1CC	5.700	
3VL4731-2DK36-□□□□		1	1 unit	1CC	5.700		3VL4731-3DK36-□□□□		1	1 unit	1CC	5.700	
3VL5731-2DK36-□□□□		1	1 unit	1CC	9.000		3VL5731-3DK36-□□□□		1	1 unit	1CC	9.000	
3VL5750-2DK36-□□□□		1	1 unit	1CC	9.000		3VL5750-3DK36-□□□□		1	1 unit	1CC	9.000	
3							3						
6							6						
3VL1710-2DE3□-□□□□		1	1 unit	1CC	2.000		--						
3VL1716-2DE3□-□□□□		1	1 unit	1CC	2.000		--						
3VL2710-2DE3□-□□□□		1	1 unit	1CC	2.200		3VL2710-3DE3□-□□□□		1	1 unit	1CC	2.200	
3VL2716-2DE3□-□□□□		1	1 unit	1CC	2.200		3VL2716-3DE3□-□□□□		1	1 unit	1CC	2.200	
3VL3725-2DE3□-□□□□		1	1 unit	1CC	2.300		3VL3725-3DE3□-□□□□		1	1 unit	1CC	2.300	
3							3						
6							6						
3VL4740-2DE36-□□□□		1	1 unit	1CC	5.700		3VL4740-3DE36-□□□□		1	1 unit	1CC	5.700	
3VL5763-2DE36-□□□□		1	1 unit	1CC	9.000		3VL5763-3DE36-□□□□		1	1 unit	1CC	9.000	
3VL6780-2DE36-□□□□		1	1 unit	1CC	15.700		3VL6780-3DE36-□□□□		1	1 unit	1CC	15.700	
3VL7712-2DE36-□□□□		1	1 unit	1CC	23.500		3VL7712-3DE36-□□□□		1	1 unit	1CC	23.500	
3VL8716-2DE30-□□□□		1	1 unit	1CC	29.800		3VL8716-3DE30-□□□□		1	1 unit	1CC	29.800	

* You can order this quantity or a multiple thereof.

Molded Case Circuit Breakers

3VL Molded Case Circuit Breakers up to 1600 A, IEC

3-pole



2

Article No. supplement (for complete Article No., see pages 2/128 to 2/144) 3VL.7 ... □□3... Trip unit	Breaking capacity	Type VL160¹⁾ 3VL2	VL250¹⁾ 3VL3		VL400 3VL4		VL630 3VL5		VL800 3VL6		VL1250 3VL7		VL1600 3VL8	
			Rated current I_n											
			63 A	100 A	160 A	200 A	250 A	315 A	400 A	500 A	630 A	800 A	1000 A	1250 A
Price														
ETU10	SB	N H L	✓	✓	✓	✓	✓	✓	✓	✓	✓	✓	✓	✓
ETU10	MB	N H L	✓	✓	✓	✓	✓	✓	✓	✓	✓	✓	✓	✓
ETU10	LB	N H L	✓	✓	✓	✓	✓	✓	✓	✓	✓	✓	✓	✓
ETU12	SL	N H L	✓	✓	✓	✓	✓	✓	✓	✓	✓	✓	✓	✓
ETU12	ML	N H L	✓	✓	✓	✓	✓	✓	✓	✓	✓	✓	✓	✓
ETU12	SF	N H L	✓	✓	✓	✓	✓	✓	✓	✓	✓	✓	✓	✓
ETU12	MF	N H L	✓	✓	✓	✓	✓	✓	✓	✓	✓	✓	✓	✓
ETU20	SE	N H L	✓	✓	✓	✓	✓	✓	✓	✓	✓	✓	✓	✓
ETU20	ME	N H L	✓	✓	✓	✓	✓	✓	✓	✓	✓	✓	✓	✓
ETU20	LE	N H L	✓	✓	✓	✓	✓	✓	✓	✓	✓	✓	✓	✓
ETU22	SG	N H L	✓	✓	✓	✓	✓	✓	✓	✓	✓	✓	✓	✓
ETU22	MG	N H L	✓	✓	✓	✓	✓	✓	✓	✓	✓	✓	✓	✓
ETU42	UL	N H L	✓	✓	✓	✓	✓	✓	✓	✓	✓	✓	✓	✓
ETU42	UM	N H L	✓	✓	✓	✓	✓	✓	✓	✓	✓	✓	✓	✓
ETU22	SH	N H L	✓	✓	✓	✓	✓	✓	✓	✓	✓	✓	✓	✓
ETU22	MH	N H L	✓	✓	✓	✓	✓	✓	✓	✓	✓	✓	✓	✓
ETU40	UH	N H L	✓	✓	✓	✓	✓	✓	✓	✓	✓	✓	✓	✓

✓ Available

-- Not available

¹⁾ The basic price is reduced when the molded case circuit breaker is ordered with a flat screw terminal ".36-".

Article No. supplement (for complete Article No. see pages 2/128 to 2/144) 3VL.7 .. - .□□3-..... Trip unit	Breaking capacity	Type	VL160 ¹⁾		VL250 ¹⁾		VL400		VL630		VL800		VL1250		VL1600	
		3VL2	3VL3		3VL4		3VL5		3VL6		3VL7		3VL8			
		Rated current I_n														
		63 A	100 A	160 A	200 A	250 A	315 A	400 A	500 A	630 A	800 A	1000 A	1250 A	1600 A	Price	
ETU10M SP		✓	✓	✓	✓	✓	✓	--	✓	--	--	--	--	--		
		✓	✓	✓	✓	✓	✓	--	✓	--	--	--	--	--		
		✓	✓	✓	✓	✓	✓	--	✓	--	--	--	--	--		
ETU10M MP		✓	✓	✓	✓	✓	✓	--	✓	--	--	--	--	--		
		✓	✓	✓	✓	✓	✓	--	✓	--	--	--	--	--		
		✓	✓	✓	✓	✓	✓	--	✓	--	--	--	--	--		
ETU30M SS		✓	✓	✓	✓	✓	✓	--	✓	--	--	--	--	--		
		✓	✓	✓	✓	✓	✓	--	✓	--	--	--	--	--		
		✓	✓	✓	✓	✓	✓	--	✓	--	--	--	--	--		
ETU30M MS		✓	✓	✓	✓	✓	✓	--	✓	--	--	--	--	--		
		✓	✓	✓	✓	✓	✓	--	✓	--	--	--	--	--		
		✓	✓	✓	✓	✓	✓	--	✓	--	--	--	--	--		
ETU30M LS		✓	✓	✓	✓	✓	✓	--	✓	--	--	--	--	--		
		✓	✓	✓	✓	✓	✓	--	✓	--	--	--	--	--		
		✓	✓	✓	✓	✓	✓	--	✓	--	--	--	--	--		
ETU40M UP		✓	✓	✓	✓	✓	✓	--	✓	--	--	--	--	--		
		✓	✓	✓	✓	✓	✓	--	✓	--	--	--	--	--		
		✓	✓	✓	✓	✓	✓	--	✓	--	--	--	--	--		

✓ Available

-- Not available

1) The basic price is reduced when the molded case circuit breaker is ordered with a flat screw terminal ".36-".

Molded Case Circuit Breakers

3VL Molded Case Circuit Breakers up to 1600 A, IEC

4-pole

Selection and ordering data

Type	Rated current I_n	Current setting of the inverse-time delayed overcurrent protection "L" I_R	Operating current of the instantaneous short-circuit protection "I" I_i	DT	I_{cu} up to 55 kA at 415 V, standard breaking capacity N See "Overview".					
	A	A	A		Article No. Article No. supplement, see page 2/172; www.siemens.com/ product?ArticleNo.	Basic price per PU	PU (UNIT, SET, M)	PS*/ P. unit	PG	Weight per PU approx. kg

4-pole, fixed-mounted, for line protection, 16 A to 630 A, thermal-magnetic overcurrent releases LI

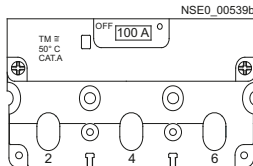

Line protection, TM, LI function

With non-adjustable thermal overcurrent releases, non-adjustable short-circuit releases, without overcurrent and short-circuit release in the 4th pole (N)

VL160X/3VL1	16	16	300	3VL1796-1EH4□-□□□□	1	1 unit	1CC	2.300
	20	20	300	3VL1702-1EH4□-□□□□	1	1 unit	1CC	2.300
	25	25	300	3VL1725-1EH4□-□□□□	1	1 unit	1CC	2.500
	32	32	300	3VL1703-1EH4□-□□□□	1	1 unit	1CC	2.500
	40	40	600	3VL1704-1EH4□-□□□□	1	1 unit	1CC	2.500
	50	50	600	3VL1705-1EH4□-□□□□	1	1 unit	1CC	2.500
	63	63	600	3VL1706-1EH4□-□□□□	1	1 unit	1CC	2.500
	80	80	1000	3VL1708-1EH4□-□□□□	1	1 unit	1CC	2.500
	100	100	1000	3VL1710-1EH4□-□□□□	1	1 unit	1CC	2.500
	125	125	1000	3VL1712-1EH4□-□□□□	1	1 unit	1CC	2.500
	160	160	1500	3VL1716-1EH4□-□□□□	1	1 unit	1CC	2.500

Connection type can be selected by assignment of the 12th position of the Article No.

- Connection with box terminal
- Connection with screw terminal not in conjunction with RCD module¹⁾

3
6

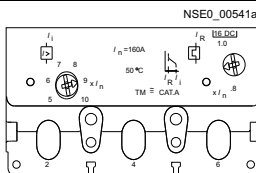

Line protection, TM, LI function

With adjustable thermal overcurrent releases, adjustable short-circuit releases, without overcurrent and short-circuit release in the 4th pole (N)

VL160/3VL2	50	40 ... 50	300 ... 600	3VL2705-1EJ4□-□□□□	1	1 unit	1CC	3.000
	63	50 ... 63	300 ... 600	3VL2706-1EJ4□-□□□□	1	1 unit	1CC	3.000
	80	63 ... 80	400 ... 800	3VL2708-1EJ4□-□□□□	1	1 unit	1CC	3.000
	100	80 ... 100	500 ... 1000	3VL2710-1EJ4□-□□□□	1	1 unit	1CC	3.000
	125	100 ... 125	625 ... 1250	3VL2712-1EJ4□-□□□□	1	1 unit	1CC	3.000
	160	125 ... 160	800 ... 1600	3VL2716-1EJ4□-□□□□	1	1 unit	1CC	3.000
VL250/3VL3	200	160 ... 200	1000 ... 2000	3VL3720-1EJ4□-□□□□	1	1 unit	1CC	3.200
	250	200 ... 250	1250 ... 2500	3VL3725-1EJ4□-□□□□	1	1 unit	1CC	3.200

Connection type can be selected by assignment of the 12th position of the Article No.

- Connection with box terminal
- Connection with flat screw terminal¹⁾

3
6

VL400/3VL4	200	160 ... 200	1000 ... 2000	3VL4720-1EJ46-□□□□	1	1 unit	1CC	7.400
	250	200 ... 250	1250 ... 2500	3VL4725-1EJ46-□□□□	1	1 unit	1CC	7.400
	315	250 ... 315	1575 ... 3150	3VL4731-1EJ46-□□□□	1	1 unit	1CC	7.400
	400	320 ... 400	2000 ... 4000	3VL4740-1EJ46-□□□□	1	1 unit	1CC	7.400
VL630/3VL5	315	250 ... 315	1575 ... 3150	3VL5731-1EJ46-□□□□	1	1 unit	1CC	11.200
	400	320 ... 400	2000 ... 4000	3VL5740-1EJ46-□□□□	1	1 unit	1CC	11.200
	500	400 ... 500	2500 ... 5000	3VL5750-1EJ46-□□□□	1	1 unit	1CC	11.200
	630	500 ... 630	3150 ... 6300	3VL5763-1EJ46-□□□□	1	1 unit	1CC	11.200

¹⁾ When the circuit breaker with flat screw terminal is ordered, the basic price is reduced.

Molded Case Circuit Breakers

3VL Molded Case Circuit Breakers up to 1600 A, IEC

4-pole

2

DT	I_{cu} up to 70 kA at 415 V, high breaking capacity H	(H)	DT	I_{cu} up to 100 kA at 415 V, very high breaking capacity L	(L)							
	Article No. Article No. supplement, see page 2/172; www.siemens.com/ product?Article No.	Basic price per PU	PU (UNIT, SET, M)	PS*/ P. unit	PG	Weight per PU approx. kg	Article No. Article No. supplement, see page 2/172; www.siemens.com/ product?Article No.	Basic price per PU	PU (UNIT, SET, M)	PS*/ P. unit	PG	Weight per PU approx. kg

3VL1796-2EH4□-□□□□	1	1 unit	1CC	2.300	--
3VL1702-2EH4□-□□□□	1	1 unit	1CC	2.300	--
3VL1725-2EH4□-□□□□	1	1 unit	1CC	2.500	--
3VL1703-2EH4□-□□□□	1	1 unit	1CC	2.500	--
3VL1704-2EH4□-□□□□	1	1 unit	1CC	2.500	--
3VL1705-2EH4□-□□□□	1	1 unit	1CC	2.500	--
3VL1706-2EH4□-□□□□	1	1 unit	1CC	2.500	--
3VL1708-2EH4□-□□□□	1	1 unit	1CC	2.500	--
3VL1710-2EH4□-□□□□	1	1 unit	1CC	2.500	--
3VL1712-2EH4□-□□□□	1	1 unit	1CC	2.500	--
3VL1716-2EH4□-□□□□	1	1 unit	1CC	2.500	--

3
6

3VL2705-2EJ4□-□□□□	1	1 unit	1CC	3.000	3VL2705-3EJ4□-□□□□	1	1 unit	1CC	3.000
3VL2706-2EJ4□-□□□□	1	1 unit	1CC	3.000	3VL2706-3EJ4□-□□□□	1	1 unit	1CC	3.000
3VL2708-2EJ4□-□□□□	1	1 unit	1CC	3.000	3VL2708-3EJ4□-□□□□	1	1 unit	1CC	3.000
3VL2710-2EJ4□-□□□□	1	1 unit	1CC	3.000	3VL2710-3EJ4□-□□□□	1	1 unit	1CC	3.000
3VL2712-2EJ4□-□□□□	1	1 unit	1CC	3.000	3VL2712-3EJ4□-□□□□	1	1 unit	1CC	3.000
3VL2716-2EJ4□-□□□□	1	1 unit	1CC	3.000	3VL2716-3EJ4□-□□□□	1	1 unit	1CC	3.000
3VL3720-2EJ4□-□□□□	1	1 unit	1CC	3.200	3VL3720-3EJ4□-□□□□	1	1 unit	1CC	3.200
3VL3725-2EJ4□-□□□□	1	1 unit	1CC	3.200	3VL3725-3EJ4□-□□□□	1	1 unit	1CC	3.200

3
6

3
6

3VL4720-2EJ46-□□□□	1	1 unit	1CC	7.400	3VL4720-3EJ46-□□□□	1	1 unit	1CC	7.400
3VL4725-2EJ46-□□□□	1	1 unit	1CC	7.400	3VL4725-3EJ46-□□□□	1	1 unit	1CC	7.400
3VL4731-2EJ46-□□□□	1	1 unit	1CC	7.400	3VL4731-3EJ46-□□□□	1	1 unit	1CC	7.400
3VL4740-2EJ46-□□□□	1	1 unit	1CC	7.400	3VL4740-3EJ46-□□□□	1	1 unit	1CC	7.400
3VL5731-2EJ46-□□□□	1	1 unit	1CC	11.200	3VL5731-3EJ46-□□□□	1	1 unit	1CC	11.200
3VL5740-2EJ46-□□□□	1	1 unit	1CC	11.200	3VL5740-3EJ46-□□□□	1	1 unit	1CC	11.200
3VL5750-2EJ46-□□□□	1	1 unit	1CC	11.200	3VL5750-3EJ46-□□□□	1	1 unit	1CC	11.200
3VL5763-2EJ46-□□□□	1	1 unit	1CC	11.200	3VL5763-3EJ46-□□□□	1	1 unit	1CC	11.200

Molded Case Circuit Breakers

3VL Molded Case Circuit Breakers up to 1600 A, IEC

4-pole

2

Type	Rated current I_n	Current setting of the inverse-time delayed overcurrent protection "L" I_R	Operating current of the instantaneous short-circuit protection "I" I_i	DT	I_{cu} up to 55 kA at 415 V, standard breaking capacity N See "Overview".					
	A	A	A		Article No.	Basic price per PU	PU (UNIT, SET, M)	PS*/P. unit	PG	Weight per PU approx. kg

4-pole, fixed-mounted, for line protection, 16 A to 160 A, thermal-magnetic overcurrent releases LIN

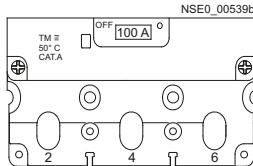

Line protection, TM, LIN function

With non-adjustable thermal overcurrent releases, non-adjustable short-circuit releases, with "N" overcurrent and short-circuit release
 N protection = 100 %

VL160X/3VL1	I_n	I_R	I_i	Article No.	PU	PS*/P. unit	PG	Weight per PU approx. kg
	16	16	300	3VL1796-1EA4□-□□□□	1	1 unit	1CC	2,300
	20	20	300	3VL1702-1EA4□-□□□□	1	1 unit	1CC	2,300
	25	25	300	3VL1725-1EA4□-□□□□	1	1 unit	1CC	2,500
	32	32	300	3VL1703-1EA4□-□□□□	1	1 unit	1CC	2,500
	40	40	600	3VL1704-1EA4□-□□□□	1	1 unit	1CC	2,500
	50	50	600	3VL1705-1EA4□-□□□□	1	1 unit	1CC	2,500
	63	63	600	3VL1706-1EA4□-□□□□	1	1 unit	1CC	2,500
	80	80	1000	3VL1708-1EA4□-□□□□	1	1 unit	1CC	2,500
	100	100	1000	3VL1710-1EA4□-□□□□	1	1 unit	1CC	2,500
	125	125	1000	3VL1712-1EL4□-□□□□	1	1 unit	1CC	2,500
	160	160	1500	3VL1716-1EL4□-□□□□	1	1 unit	1CC	2,500

Connection type can be selected by assignment of the 12th position of the Article No.

- Connection with box terminal **3**
- Connection with screw terminal not in conjunction with RCD module¹⁾ **6**

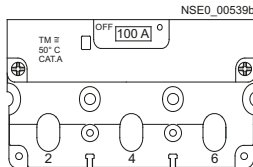

Line protection, TM, LIN function

With non-adjustable thermal overcurrent releases, non-adjustable short-circuit releases, with "N" overcurrent and short-circuit release
 N protection = 60 %

VL160X/3VL1	I_n	I_R	I_i	Article No.	PU	PS*/P. unit	PG	Weight per PU approx. kg
	125	125	1000	3VL1712-1EA4□-□□□□	1	1 unit	1CC	2,500
	160	160	1500	3VL1716-1EA4□-□□□□	1	1 unit	1CC	2,500

Connection type can be selected by assignment of the 12th position of the Article No.

- Connection with box terminal **3**
- Connection with screw terminal not in conjunction with RCD module¹⁾ **6**

¹⁾ When the circuit breaker with flat screw terminal is ordered, the basic price is reduced.

Molded Case Circuit Breakers

3VL Molded Case Circuit Breakers up to 1600 A, IEC

4-pole

2

DT	I_{cu} up to 70 kA at 415 V, high breaking capacity H						(H)	DT	I_{cu} up to 100 kA at 415 V, very high breaking capacity L						(L)
	Article No.	Basic price per PU	PU (UNIT, SET, M)	PS*/P. unit	PG	Weight per PU approx. kg		Article No.	Basic price per PU	PU (UNIT, SET, M)	PS*/P. unit	PG	Weight per PU approx. kg		

	3VL1796-2EA4□-□□□□		1	1 unit	1CC	2,300		--						
	3VL1702-2EA4□-□□□□		1	1 unit	1CC	2,300		--						
	3VL1725-2EA4□-□□□□		1	1 unit	1CC	2,500		--						
	3VL1703-2EA4□-□□□□		1	1 unit	1CC	2,500		--						
	3VL1704-2EA4□-□□□□		1	1 unit	1CC	2,500		--						
	3VL1705-2EA4□-□□□□		1	1 unit	1CC	2,500		--						
	3VL1706-2EA4□-□□□□		1	1 unit	1CC	2,500		--						
	3VL1708-2EA4□-□□□□		1	1 unit	1CC	2,500		--						
	3VL1710-2EA4□-□□□□		1	1 unit	1CC	2,500		--						
	3VL1712-2EL4□-□□□□		1	1 unit	1CC	2,500		--						
	3VL1716-2EL4□-□□□□		1	1 unit	1CC	2,500		--						

3
6

	3VL1712-2EA4□-□□□□		1	1 unit	1CC	2,500		--						
	3VL1716-2EA4□-□□□□		1	1 unit	1CC	2,500		--						

3
6

Molded Case Circuit Breakers

3VL Molded Case Circuit Breakers up to 1600 A, IEC

4-pole

2

Type	Rated current I_n	Current setting of the inverse-time delayed overcurrent protection "L" I_R	Operating current of the instantaneous short-circuit protection "I" I_I	DT	I_{cu} up to 55 kA at 415 V, standard breaking capacity N See "Overview".					
	A	A	A		Article No. Article No. supplement, see page 2/172; www.siemens.com/product?Article No.	Basic price per PU	PU (UNIT, SET, M)	PS*/P. unit	PG	Weight per PU approx. kg

4-pole, fixed-mounted, for line protection, 16 A to 630 A, thermal-magnetic overcurrent releases LIN

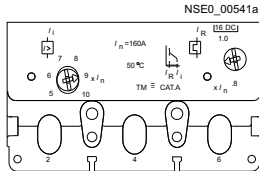

Line protection, TM, LIN function

With adjustable thermal overcurrent releases, adjustable short-circuit releases, with "N" overcurrent and short-circuit release
 N protection = 100 %

VL160/3VL2	50	40 ... 50	300 ... 600	3VL2705-1EM4□-□□□□	1	1 unit	1CC	3,000
	63	50 ... 63	300 ... 600	3VL2706-1EM4□-□□□□	1	1 unit	1CC	3,000
	80	63 ... 80	400 ... 800	3VL2708-1EM4□-□□□□	1	1 unit	1CC	3,000
	100	80 ... 100	500 ... 1000	3VL2710-1EM4□-□□□□	1	1 unit	1CC	3,000
	125	100 ... 125	625 ... 1250	3VL2712-1EM4□-□□□□	1	1 unit	1CC	3,000
VL250/3VL3	160	125 ... 160	800 ... 1600	3VL2716-1EM4□-□□□□	1	1 unit	1CC	3,000
	200	160 ... 200	1000 ... 2000	3VL3720-1EM4□-□□□□	1	1 unit	1CC	3,200
	250	200 ... 250	1250 ... 2500	3VL3725-1EM4□-□□□□	1	1 unit	1CC	3,200

Connection type can be selected by assignment of the 12th position of the Article No.

- Connection with box terminal
- Connection with flat screw terminal¹⁾

3
6

VL400/3VL4	200	160 ... 200	1000 ... 2000	3VL4720-1EM46-□□□□	1	1 unit	1CC	7,400
	250	200 ... 250	1250 ... 2500	3VL4725-1EM46-□□□□	1	1 unit	1CC	7,400
	315	250 ... 315	1575 ... 3150	3VL4731-1EM46-□□□□	1	1 unit	1CC	7,400
	400	320 ... 400	2000 ... 4000	3VL4740-1EM46-□□□□	1	1 unit	1CC	7,400
VL630/3VL5	315	250 ... 315	1575 ... 3150	3VL5731-1EM46-□□□□	1	1 unit	1CC	11,200
	400	320 ... 400	2000 ... 4000	3VL5740-1EM46-□□□□	1	1 unit	1CC	11,200
	500	400 ... 500	2500 ... 5000	3VL5750-1EM46-□□□□	1	1 unit	1CC	11,200
	630	500 ... 630	3150 ... 6300	3VL5763-1EM46-□□□□	1	1 unit	1CC	11,200

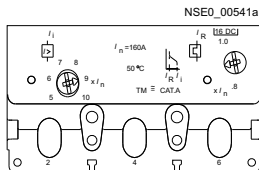

Line protection, TM, LIN function

With adjustable thermal overcurrent releases, adjustable short-circuit releases, with "N" overcurrent and short-circuit release
 N protection = 60 %

VL160/3VL2	125	100 ... 125	625 ... 1250	3VL2712-1EC4□-□□□□	1	1 unit	1CC	3,000
	160	125 ... 160	800 ... 1600	3VL2716-1EC4□-□□□□	1	1 unit	1CC	3,000
VL250/3VL3	200	160 ... 200	1000 ... 2000	3VL3720-1EC4□-□□□□	1	1 unit	1CC	3,200
	250	200 ... 250	1250 ... 2500	3VL3725-1EC4□-□□□□	1	1 unit	1CC	3,200

Connection type can be selected by assignment of the 12th position of the Article No.

- Connection with box terminal
- Connection with flat screw terminal¹⁾

3
6

VL400/3VL4	200	160 ... 200	1000 ... 2000	3VL4720-1EC46-□□□□	1	1 unit	1CC	7,400
	250	200 ... 250	1250 ... 2500	3VL4725-1EC46-□□□□	1	1 unit	1CC	7,400
	315	250 ... 315	1575 ... 3150	3VL4731-1EC46-□□□□	1	1 unit	1CC	7,400
	400	320 ... 400	2000 ... 4000	3VL4740-1EC46-□□□□	1	1 unit	1CC	7,400
VL630/3VL5	315	250 ... 315	1575 ... 3150	3VL5731-1EC46-□□□□	1	1 unit	1CC	11,200
	400	320 ... 400	2000 ... 4000	3VL5740-1EC46-□□□□	1	1 unit	1CC	11,200
	500	400 ... 500	2500 ... 5000	3VL5750-1EC46-□□□□	1	1 unit	1CC	11,200
	630	500 ... 630	3150 ... 6300	3VL5763-1EC46-□□□□	1	1 unit	1CC	11,200

¹⁾ When the circuit breaker with flat screw terminal is ordered, the basic price is reduced.

Molded Case Circuit Breakers

3VL Molded Case Circuit Breakers up to 1600 A, IEC

4-pole

2

DT I_{cu} up to 70 kA at 415 V, high breaking capacity H						DT I_{cu} up to 100 kA at 415 V, very high breaking capacity L					
Article No.	Basic price per PU	PU (UNIT, SET, M)	PS*/P. unit	PG	Weight per PU approx. kg	Article No.	Basic price per PU	PU (UNIT, SET, M)	PS*/P. unit	PG	Weight per PU approx. kg

3VL2705-2EM4□-□□□□		1	1 unit	1CC	3.000	3VL2705-3EM4□-□□□□		1	1 unit	1CC	3.000
3VL2706-2EM4□-□□□□		1	1 unit	1CC	3.000	3VL2706-3EM4□-□□□□		1	1 unit	1CC	3.000
3VL2708-2EM4□-□□□□		1	1 unit	1CC	3.000	3VL2708-3EM4□-□□□□		1	1 unit	1CC	3.000
3VL2710-2EM4□-□□□□		1	1 unit	1CC	3.000	3VL2710-3EM4□-□□□□		1	1 unit	1CC	3.000
3VL2712-2EM4□-□□□□		1	1 unit	1CC	3.000	3VL2712-3EM4□-□□□□		1	1 unit	1CC	3.000
3VL2716-2EM4□-□□□□		1	1 unit	1CC	3.000	3VL2716-3EM4□-□□□□		1	1 unit	1CC	3.000
3VL3720-2EM4□-□□□□		1	1 unit	1CC	3.200	3VL3720-3EM4□-□□□□		1	1 unit	1CC	3.200
3VL3725-2EM4□-□□□□		1	1 unit	1CC	3.200	3VL3725-3EM4□-□□□□		1	1 unit	1CC	3.200

3
6

3
6

3VL4720-2EM46-□□□□		1	1 unit	1CC	7.400	3VL4720-3EM46-□□□□		1	1 unit	1CC	7.400
3VL4725-2EM46-□□□□		1	1 unit	1CC	7.400	3VL4725-3EM46-□□□□		1	1 unit	1CC	7.400
3VL4731-2EM46-□□□□		1	1 unit	1CC	7.400	3VL4731-3EM46-□□□□		1	1 unit	1CC	7.400
3VL4740-2EM46-□□□□		1	1 unit	1CC	7.400	3VL4740-3EM46-□□□□		1	1 unit	1CC	7.400
3VL5731-2EM46-□□□□		1	1 unit	1CC	11.200	3VL5731-3EM46-□□□□		1	1 unit	1CC	11.200
3VL5740-2EM46-□□□□		1	1 unit	1CC	11.200	3VL5740-3EM46-□□□□		1	1 unit	1CC	11.200
3VL5750-2EM46-□□□□		1	1 unit	1CC	11.200	3VL5750-3EM46-□□□□		1	1 unit	1CC	11.200
3VL5763-2EM46-□□□□		1	1 unit	1CC	11.200	3VL5763-3EM46-□□□□		1	1 unit	1CC	11.200

3VL2712-2EC4□-□□□□		1	1 unit	1CC	3.000	3VL2712-3EC4□-□□□□		1	1 unit	1CC	3.000
3VL2716-2EC4□-□□□□		1	1 unit	1CC	3.000	3VL2716-3EC4□-□□□□		1	1 unit	1CC	3.000
3VL3720-2EC4□-□□□□		1	1 unit	1CC	3.200	3VL3720-3EC4□-□□□□		1	1 unit	1CC	3.200
3VL3725-2EC4□-□□□□		1	1 unit	1CC	3.200	3VL3725-3EC4□-□□□□		1	1 unit	1CC	3.200

3
6

3
6

3VL4720-2EC46-□□□□		1	1 unit	1CC	7.400	3VL4720-3EC46-□□□□		1	1 unit	1CC	7.400
3VL4725-2EC46-□□□□		1	1 unit	1CC	7.400	3VL4725-3EC46-□□□□		1	1 unit	1CC	7.400
3VL4731-2EC46-□□□□		1	1 unit	1CC	7.400	3VL4731-3EC46-□□□□		1	1 unit	1CC	7.400
3VL4740-2EC46-□□□□		1	1 unit	1CC	7.400	3VL4740-3EC46-□□□□		1	1 unit	1CC	7.400
3VL5731-2EC46-□□□□		1	1 unit	1CC	11.200	3VL5731-3EC46-□□□□		1	1 unit	1CC	11.200
3VL5740-2EC46-□□□□		1	1 unit	1CC	11.200	3VL5740-3EC46-□□□□		1	1 unit	1CC	11.200
3VL5750-2EC46-□□□□		1	1 unit	1CC	11.200	3VL5750-3EC46-□□□□		1	1 unit	1CC	11.200
3VL5763-2EC46-□□□□		1	1 unit	1CC	11.200	3VL5763-3EC46-□□□□		1	1 unit	1CC	11.200

Molded Case Circuit Breakers

3VL Molded Case Circuit Breakers up to 1600 A, IEC

4-pole

2

Type	Rated current I_n	Current setting of the inverse-time delayed overcurrent protection "L" I_R	Operating current of the instantaneous short-circuit protection "I" I_i	DT	I_{cu} up to 55 kA at 415 V, standard breaking capacity N See "Overview".	(N)
	A	A	A		Article No. Article No. supplement, see page 2/172; www.siemens.com/product?ArticleNo.	Price PU (UNIT, SET, M) PS*/P. unit PG Weight per PU approx. kg

4-pole, fixed-mounted, for line protection, 63 A to 1600 A, Electronic Trip Units LI

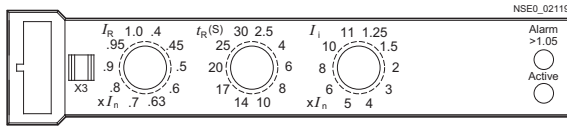
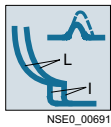

ETU10, LI function

With adjustable overcurrent releases, adjustable short-circuit releases, without overcurrent and short-circuit release in the 4th pole (N)

VL160/3VL2	63 100 160	25 ... 63 40 ... 100 64 ... 160	1.25 ... 11 × I_n 1.25 ... 11 × I_n 1.25 ... 11 × I_n	3VL2706-1□□4□-□□□□ 3VL2710-1□□4□-□□□□ 3VL2716-1□□4□-□□□□	1 1 1	1 unit 1 unit 1 unit	1CC 1CC 1CC	3.100 3.100 3.100
VL250/3VL3	200 250	80 ... 200 100 ... 250	1.25 ... 11 × I_n 1.25 ... 11 × I_n	3VL3720-1□□4□-□□□□ 3VL3725-1□□4□-□□□□	1 1	1 unit 1 unit	1CC 1CC	3.300 3.300

Connection type can be selected by assignment of the 12th position of the Article No.

- Connection with box terminal
- Connection with flat screw terminal¹⁾

3
6

VL400/3VL4	315 400	128 ... 315 160 ... 400	1.25 ... 11 × I_n 1.25 ... 11 × I_n	3VL4731-1□□46-□□□□ 3VL4740-1□□46-□□□□	1 1	1 unit 1 unit	1CC 1CC	7.600 7.600
VL630/3VL5	630	252 ... 630	1.25 ... 10 × I_n	3VL5763-1□□46-□□□□	1	1 unit	1CC	11.700
VL800/3VL6	800	320 ... 800	1.25 ... 8 × I_n	3VL6780-1□□46-□□□□	1	1 unit	1CC	20.500
VL1250/3VL7	1000 1250	400 ... 1000 500 ... 1250	1.25 ... 11 × I_n 1.25 ... 11 × I_n	3VL7710-1□□46-□□□□ 3VL7712-1□□46-□□□□	1 1	1 unit 1 unit	1CC 1CC	33.500 33.500
VL1600/3VL8 ²⁾	1600	640 ... 1600	1.25 ... 9 × I_n	3VL8716-1□□40-□□□□	1	1 unit	1CC	40.800

- Without communication preparation
- With communication preparation

TB
NB

4-pole, fixed-mounted, for line protection, 63 A to 1600 A, Electronic Trip Units LIN

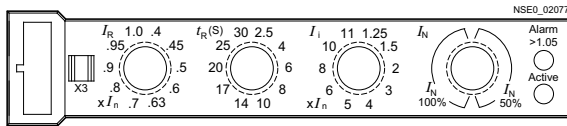
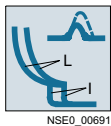

ETU10, LIN function

With adjustable overcurrent releases, adjustable short-circuit releases with overcurrent and short-circuit release in the 4th pole (N)
N protection = 50/100 %

VL160/3VL2	63 100 160	25 ... 63 40 ... 100 64 ... 160	1.25 ... 11 × I_n 1.25 ... 11 × I_n 1.25 ... 11 × I_n	3VL2706-1□□4□-□□□□ 3VL2710-1□□4□-□□□□ 3VL2716-1□□4□-□□□□	1 1 1	1 unit 1 unit 1 unit	1CC 1CC 1CC	3.100 3.100 3.100
VL250/3VL3	200 250	80 ... 200 100 ... 250	1.25 ... 11 × I_n 1.25 ... 11 × I_n	3VL3720-1□□4□-□□□□ 3VL3725-1□□4□-□□□□	1 1	1 unit 1 unit	1CC 1CC	3.300 3.300

Connection type can be selected by assignment of the 12th position of the Article No.

- Connection with box terminal
- Connection with flat screw terminal¹⁾

3
6

VL400/3VL4	315 400	128 ... 315 160 ... 400	1.25 ... 11 × I_n 1.25 ... 11 × I_n	3VL4731-1□□46-□□□□ 3VL4740-1□□46-□□□□	1 1	1 unit 1 unit	1CC 1CC	7.600 7.600
VL630/3VL5	630	252 ... 630	1.25 ... 10 × I_n	3VL5763-1□□46-□□□□	1	1 unit	1CC	11.700
VL800/3VL6	800	320 ... 800	1.25 ... 8 × I_n	3VL6780-1□□46-□□□□	1	1 unit	1CC	20.500
VL1250/3VL7	1000 1250	400 ... 1000 500 ... 1250	1.25 ... 11 × I_n 1.25 ... 11 × I_n	3VL7710-1□□46-□□□□ 3VL7712-1□□46-□□□□	1 1	1 unit 1 unit	1CC 1CC	33.500 33.500
VL1600/3VL8 ²⁾	1600	640 ... 1600	1.25 ... 9 × I_n	3VL8716-1□□40-□□□□	1	1 unit	1CC	40.800

- Without communication preparation
- With communication preparation
- Marine engineering-certified LRS, DNV, GL and BV (not communication-ready)

TA
NA
LA

¹⁾ When the circuit breaker with flat screw terminal is ordered, the basic price is reduced.

²⁾ Front busbar connection pieces are included in the scope of supply and are to be fitted by the customer.

Molded Case Circuit Breakers

3VL Molded Case Circuit Breakers up to 1600 A, IEC

4-pole

2

DT	I_{cu} up to 70 kA at 415 V, high breaking capacity H	(H)	DT	I_{cu} up to 100 kA at 415 V, very high breaking capacity L	(L)						
Article No.	Price	PU (UNIT, SET, M)	PS*/P. unit	PG	Weight per PU approx. kg	Article No.	Price	PU (UNIT, SET, M)	PS*/P. unit	PG	Weight per PU approx. kg

3VL2706-2□□4□-□□□□		1	1 unit	1CC	3.100	3VL2706-3□□4□-□□□□		1	1 unit	1CC	3.100
3VL2710-2□□4□-□□□□		1	1 unit	1CC	3.100	3VL2710-3□□4□-□□□□		1	1 unit	1CC	3.100
3VL2716-2□□4□-□□□□		1	1 unit	1CC	3.100	3VL2716-3□□4□-□□□□		1	1 unit	1CC	3.100
3VL3720-2□□4□-□□□□		1	1 unit	1CC	3.300	3VL3720-3□□4□-□□□□		1	1 unit	1CC	3.300
3VL3725-2□□4□-□□□□		1	1 unit	1CC	3.300	3VL3725-3□□4□-□□□□		1	1 unit	1CC	3.300

3
6

3
6

3VL4731-2□□46-□□□□		1	1 unit	1CC	7.600	3VL4731-3□□46-□□□□		1	1 unit	1CC	7.600
3VL4740-2□□46-□□□□		1	1 unit	1CC	7.600	3VL4740-3□□46-□□□□		1	1 unit	1CC	7.600
3VL5763-2□□46-□□□□		1	1 unit	1CC	11.700	3VL5763-3□□46-□□□□		1	1 unit	1CC	11.700
3VL6780-2□□46-□□□□		1	1 unit	1CC	20.500	3VL6780-3□□46-□□□□		1	1 unit	1CC	20.500
3VL7710-2□□46-□□□□		1	1 unit	1CC	33.500	3VL7710-3□□46-□□□□		1	1 unit	1CC	33.500
3VL7712-2□□46-□□□□		1	1 unit	1CC	33.500	3VL7712-3□□46-□□□□		1	1 unit	1CC	33.500
3VL8716-2□□40-□□□□		1	1 unit	1CC	40.800	3VL8716-3□□40-□□□□		1	1 unit	1CC	40.800

TB
NB

TB
NB

3VL2706-2□□4□-□□□□		1	1 unit	1CC	3.100	3VL2706-3□□4□-□□□□		1	1 unit	1CC	3.100
3VL2710-2□□4□-□□□□		1	1 unit	1CC	3.100	3VL2710-3□□4□-□□□□		1	1 unit	1CC	3.100
3VL2716-2□□4□-□□□□		1	1 unit	1CC	3.100	3VL2716-3□□4□-□□□□		1	1 unit	1CC	3.100
3VL3720-2□□4□-□□□□		1	1 unit	1CC	3.300	3VL3720-3□□4□-□□□□		1	1 unit	1CC	3.300
3VL3725-2□□4□-□□□□		1	1 unit	1CC	3.300	3VL3725-3□□4□-□□□□		1	1 unit	1CC	3.300

3
6

3
6

3VL4731-2□□46-□□□□		1	1 unit	1CC	7.600	3VL4731-3□□46-□□□□		1	1 unit	1CC	7.600
3VL4740-2□□46-□□□□		1	1 unit	1CC	7.600	3VL4740-3□□46-□□□□		1	1 unit	1CC	7.600
3VL5763-2□□46-□□□□		1	1 unit	1CC	11.700	3VL5763-3□□46-□□□□		1	1 unit	1CC	11.700
3VL6780-2□□46-□□□□		1	1 unit	1CC	20.500	3VL6780-3□□46-□□□□		1	1 unit	1CC	20.500
3VL7710-2□□46-□□□□		1	1 unit	1CC	33.500	3VL7710-3□□46-□□□□		1	1 unit	1CC	33.500
3VL7712-2□□46-□□□□		1	1 unit	1CC	33.500	3VL7712-3□□46-□□□□		1	1 unit	1CC	33.500
3VL8716-2□□40-□□□□		1	1 unit	1CC	40.800	3VL8716-3□□40-□□□□		1	1 unit	1CC	40.800

TA
NA
LA

TA
NA
LA

Communication:

- For accessories, see page 2/207.

- For more information, see also chapter "Measuring Devices and Power Monitoring" and chapter "Software".

Molded Case Circuit Breakers

3VL Molded Case Circuit Breakers up to 1600 A, IEC

4-pole

2

Type	Rated current I_n	Current setting of the inverse-time delayed overcurrent protection "L" I_R	Operating current of the instantaneous short-circuit protection "I" I_i	Ground-fault protection "G" I_g	DT	I_{cu} up to 55 kA at 415 V, standard breaking capacity N See "Overview".				(N)	
	A	A	A	A		Article No. Article No. supplement, see page 2/172; www.siemens.com/product?Article No.	Price	PU (UNIT, SET, M)	PS*/P. unit	PG	Weight per PU approx. kg

4-pole, fixed-mounted, for line protection, 63 A to 1600 A, Electronic Trip Units LING

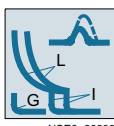

NSE0_00693

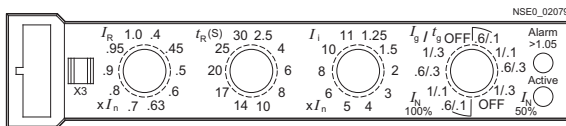

ETU12, LING function for 4-wire three-phase systems

With adjustable overcurrent releases, adjustable short-circuit releases, vectorial summation current formation, ground-fault delay $t_{G0} = 0.1 \dots 0.3$ s, ground-fault protection (G) can be switched off with overcurrent and short-circuit release in the 4th pole (N), N protection = 50/100 %

VL160/3VL2	63	25 ... 63	1.25 ... $11 \times I_n$	0.6 ... $1 \times I_n$, OFF	3VL2706-1□□4□-□□□□	1	1 unit	1CC	3.100
	100	40 ... 100	1.25 ... $11 \times I_n$	0.6 ... $1 \times I_n$, OFF	3VL2710-1□□4□-□□□□	1	1 unit	1CC	3.100
	160	64 ... 160	1.25 ... $11 \times I_n$	0.6 ... $1 \times I_n$, OFF	3VL2716-1□□4□-□□□□	1	1 unit	1CC	3.100
VL250/3VL3	200	80 ... 200	1.25 ... $11 \times I_n$	0.6 ... $1 \times I_n$, OFF	3VL3720-1□□4□-□□□□	1	1 unit	1CC	3.300
	250	100 ... 250	1.25 ... $11 \times I_n$	0.6 ... $1 \times I_n$, OFF	3VL3725-1□□4□-□□□□	1	1 unit	1CC	3.300

Connection type can be selected by assignment of the 12th position of the Article No.

- Connection with box terminal
- Connection with flat screw terminal¹⁾

3
6

VL400/3VL4	315	128 ... 315	1.25 ... $11 \times I_n$	0.6 ... $1 \times I_n$, OFF	3VL4731-1□□46-□□□□	1	1 unit	1CC	7.600
	400	160 ... 400	1.25 ... $11 \times I_n$	0.6 ... $1 \times I_n$, OFF	3VL4740-1□□46-□□□□	1	1 unit	1CC	7.600
VL630/3VL5	630	252 ... 630	1.25 ... $10 \times I_n$	0.6 ... $1 \times I_n$, OFF	3VL5763-1□□46-□□□□	1	1 unit	1CC	11.700
VL800/3VL6	800	320 ... 800	1.25 ... $8 \times I_n$	0.6 ... $1 \times I_n$, OFF	3VL6780-1□□46-□□□□	1	1 unit	1CC	20.500
VL1250/3VL7	1000	400 ... 1000	1.25 ... $11 \times I_n$	0.6 ... $1 \times I_n$, OFF	3VL7710-1□□46-□□□□	1	1 unit	1CC	33.500
	1250	500 ... 1250	1.25 ... $11 \times I_n$	0.6 ... $1 \times I_n$, OFF	3VL7712-1□□46-□□□□	1	1 unit	1CC	33.500
VL1600/3VL8 ²⁾	1600	640 ... 1600	1.25 ... $9 \times I_n$	0.6 ... $1 \times I_n$, OFF	3VL8716-1□□40-□□□□	1	1 unit	1CC	40.800

- Without communication preparation
- With communication preparation

TN
NN

¹⁾ When the circuit breaker with flat screw terminal is ordered, the basic price is reduced.

²⁾ Front busbar connection pieces are included in the scope of supply and are to be fitted by the customer.

Communication:

- For accessories, see page 2/207.
- For more information, see also chapter "Measuring Devices and Power Monitoring" and chapter "Software".

Molded Case Circuit Breakers

3VL Molded Case Circuit Breakers up to 1600 A, IEC

4-pole

2

DT I_{cu} up to 70 kA at 415 V, high breaking capacity H						DT I_{cu} up to 100 kA at 415 V, very high breaking capacity L					
Article No.	Price	PU (UNIT, SET, M)	PS* / P. unit	PG	Weight per PU approx.	Article No.	Price	PU (UNIT, SET, M)	PS* / P. unit	PG	Weight per PU approx.
www.siemens.com/product?Article.No.						www.siemens.com/product?Article.No.					
kg						kg					

3VL2706-2□□4□-□□□□		1	1 unit	1CC	3.100	3VL2706-3□□4□-□□□□		1	1 unit	1CC	3.100
3VL2710-2□□4□-□□□□		1	1 unit	1CC	3.100	3VL2710-3□□4□-□□□□		1	1 unit	1CC	3.100
3VL2716-2□□4□-□□□□		1	1 unit	1CC	3.100	3VL2716-3□□4□-□□□□		1	1 unit	1CC	3.100
3VL3720-2□□4□-□□□□		1	1 unit	1CC	3.300	3VL3720-3□□4□-□□□□		1	1 unit	1CC	3.300
3VL3725-2□□4□-□□□□		1	1 unit	1CC	3.300	3VL3725-3□□4□-□□□□		1	1 unit	1CC	3.300

3
6

3
6

3VL4731-2□□46-□□□□		1	1 unit	1CC	7.600	3VL4731-3□□46-□□□□		1	1 unit	1CC	7.600
3VL4740-2□□46-□□□□		1	1 unit	1CC	7.600	3VL4740-3□□46-□□□□		1	1 unit	1CC	7.600
3VL5763-2□□46-□□□□		1	1 unit	1CC	11.700	3VL5763-3□□46-□□□□		1	1 unit	1CC	11.700
3VL6780-2□□46-□□□□		1	1 unit	1CC	20.500	3VL6780-3□□46-□□□□		1	1 unit	1CC	20.500
3VL7710-2□□46-□□□□		1	1 unit	1CC	33.500	3VL7710-3□□46-□□□□		1	1 unit	1CC	33.500
3VL7712-2□□46-□□□□		1	1 unit	1CC	33.500	3VL7712-3□□46-□□□□		1	1 unit	1CC	33.500
3VL8716-2□□40-□□□□		1	1 unit	1CC	40.800	3VL8716-3□□40-□□□□		1	1 unit	1CC	40.800

TN
NN

TN
NN

Molded Case Circuit Breakers

3VL Molded Case Circuit Breakers up to 1600 A, IEC

4-pole

2

Type	Rated current I_n	Current setting of the inverse-time delayed overcurrent protection "L" I_R	Operating current of the instantaneous short-circuit protection "I" I_i	S function short-circuit protection (short-time delayed) S	DT	I_{cu} up to 55 kA at 415 V, standard breaking capacity N See "Overview".					(N)
	A	A	A	A		Article No. Article No. supplement, see page 2/172; www.siemens.com/product?Article.No.	Basic price per PU	PU (UNIT, SET, M)	PS*/P. unit	PG	Weight per PU approx.

4-pole, fixed-mounted, for line protection – generator protection, 63 A to 1600 A, Electronic Trip Units LI, LSI, LIN, LSIN

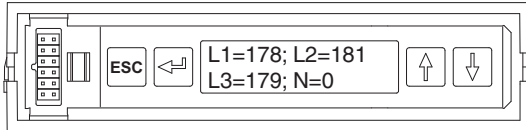
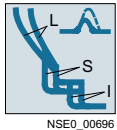

LCD-ETU40, LI/LSI/LIN/LSIN function selectable

With adjustable overcurrent releases, adjustable short-circuit releases, short-circuit delay $t_{sd} = 0 \dots 0.5$ s with overcurrent and short-circuit release in the 4th pole (N), N protection = 50 ... 100 %, OFF

VL160/3VL2	63 ¹⁾	25 ... 63	$1.25 \dots 11 \times I_n$	$1.5 \dots 10 \times I_R$	3VL2706-1UJ4□-□□□□	1	1 unit	1CC	3.100
	100 ¹⁾	40 ... 100	$1.25 \dots 11 \times I_n$	$1.5 \dots 10 \times I_R$	3VL2710-1UJ4□-□□□□	1	1 unit	1CC	3.100
	160	64 ... 160	$1.25 \dots 11 \times I_n$	$1.5 \dots 10 \times I_R$	3VL2716-1UJ4□-□□□□	1	1 unit	1CC	3.100
VL250/3VL3	200	80 ... 200	$1.25 \dots 11 \times I_n$	$1.5 \dots 10 \times I_R$	3VL3720-1UJ4□-□□□□	1	1 unit	1CC	3.300
	250	100 ... 250	$1.25 \dots 11 \times I_n$	$1.5 \dots 10 \times I_R$	3VL3725-1UJ4□-□□□□	1	1 unit	1CC	3.300

Connection type can be selected by assignment of the 12th position of the Article No.

- Connection with box terminal
- Connection with flat screw terminal²⁾

3
6

VL400/3VL4	315	128 ... 315	$1.25 \dots 11 \times I_n$	$1.5 \dots 10 \times I_R$	3VL4731-1UJ46-□□□□	1	1 unit	1CC	7.600
	400	160 ... 400	$1.25 \dots 11 \times I_n$	$1.5 \dots 10 \times I_R$	3VL4740-1UJ46-□□□□	1	1 unit	1CC	7.600
VL630/3VL5	630	252 ... 630	$1.25 \dots 10 \times I_n$	$1.5 \dots 9 \times I_R$	3VL5763-1UJ46-□□□□	1	1 unit	1CC	11.700
VL800/3VL6	800	320 ... 800	$1.25 \dots 8 \times I_n$	$1.5 \dots 7 \times I_R$	3VL6780-1UJ46-□□□□	1	1 unit	1CC	20.500
VL1250/3VL7	1000	400 ... 1000	$1.25 \dots 11 \times I_n$	$1.5 \dots 10 \times I_R$	3VL7710-1UJ46-□□□□	1	1 unit	1CC	33.500
	1250	500 ... 1250	$1.25 \dots 11 \times I_n$	$1.5 \dots 10 \times I_R$	3VL7712-1UJ46-□□□□	1	1 unit	1CC	33.500
VL1600/3VL8 ³⁾	1600	640 ... 1600	$1.25 \dots 9 \times I_n$	$1.5 \dots 8 \times I_R$	3VL8716-1UJ40-□□□□	1	1 unit	1CC	40.800

¹⁾ N = 100 % protection for $I_n \leq 100$ A.

²⁾ When the circuit breaker with flat screw terminal is ordered, the basic price is reduced.

³⁾ Front busbar connection pieces are included in the scope of supply and are to be fitted by the customer.

Molded Case Circuit Breakers

3VL Molded Case Circuit Breakers up to 1600 A, IEC

4-pole

2

DT	I_{cu} up to 70 kA at 415 V, high breaking capacity H					(H)	DT	I_{cu} up to 100 kA at 415 V, very high breaking capacity L					(L)
	Article No.	Basic price per PU	PU (UNIT, SET, M)	PS*/P. unit	PG	Weight per PU approx.		Article No.	Basic price per PU	PU (UNIT, SET, M)	PS*/P. unit	PG	Weight per PU approx.
	Article No. supplement, see page 2/172; www.siemens.com/product?Article No.					kg		Article No. supplement, see page 2/172; www.siemens.com/product?Article No.					kg

3VL2706-2UJ4□-□□□□	1	1 unit	1CC	3.100			3VL2706-3UJ4□-□□□□	1	1 unit	1CC	3.100		
3VL2710-2UJ4□-□□□□	1	1 unit	1CC	3.100			3VL2710-3UJ4□-□□□□	1	1 unit	1CC	3.100		
3VL2716-2UJ4□-□□□□	1	1 unit	1CC	3.100			3VL2716-3UJ4□-□□□□	1	1 unit	1CC	3.100		
3VL3720-2UJ4□-□□□□	1	1 unit	1CC	3.300			3VL3720-3UJ4□-□□□□	1	1 unit	1CC	3.300		
3VL3725-2UJ4□-□□□□	1	1 unit	1CC	3.300			3VL3725-3UJ4□-□□□□	1	1 unit	1CC	3.300		

3
6

3
6

3VL4731-2UJ46-□□□□	1	1 unit	1CC	7.600			3VL4731-3UJ46-□□□□	1	1 unit	1CC	7.600		
3VL4740-2UJ46-□□□□	1	1 unit	1CC	7.600			3VL4740-3UJ46-□□□□	1	1 unit	1CC	7.600		
3VL5763-2UJ46-□□□□	1	1 unit	1CC	11.700			3VL5763-3UJ46-□□□□	1	1 unit	1CC	11.700		
3VL6780-2UJ46-□□□□	1	1 unit	1CC	20.500			3VL6780-3UJ46-□□□□	1	1 unit	1CC	20.500		
3VL7710-2UJ46-□□□□	1	1 unit	1CC	33.500			3VL7710-3UJ46-□□□□	1	1 unit	1CC	33.500		
3VL7712-2UJ46-□□□□	1	1 unit	1CC	33.500			3VL7712-3UJ46-□□□□	1	1 unit	1CC	33.500		
3VL8716-2UJ40-□□□□	1	1 unit	1CC	40.800			3VL8716-3UJ40-□□□□	1	1 unit	1CC	40.800		

Molded Case Circuit Breakers

3VL Molded Case Circuit Breakers up to 1600 A, IEC

4-pole

2

Type	Rated current I_n	Current setting of the inverse-time delayed overcurrent protection "L" I_R	Operating current of the instantaneous short-circuit protection "I" I_f	S function short-circuit protection (short-time delayed)	Ground-fault protection "G" I_g	DT	I_{cu} up to 55 kA at 415 V, standard breaking capacity N See "Overview".					(N)
	A	A	A	A	A		Article No. Article No. supplement, see page 2/172; www.siemens.com/product?Article.No.	Basic price per PU	PU (UNIT, SET, M)	PS*/P. unit	PG	Weight per PU approx. kg

4-pole, fixed-mounted, for line protection – generator protection, 63 A to 1600 A, Electronic Trip Units LSIG, LSING

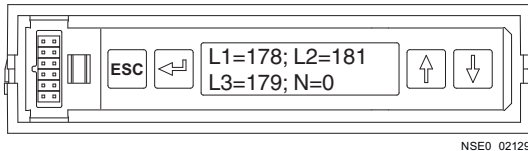

LCD-ETU42, LSIG/LSING function for 4-wire three-phase systems and time-based discrimination

With adjustable overcurrent releases, adjustable short-circuit releases
 Ground fault delay $t_g = 0.1 \dots 0.5$ s, short-circuit delay $t_{sd} = 0 \dots 0.5$ s
 with overcurrent and short-circuit release in the 4th pole (N), N protection = 50 ... 100 %, OFF

VL160/3VL2	63	25 ... 63	1.25 ... $11 \times I_n$	1.5 ... $10 \times I_R$	0.4 ... $1 \times I_n$	3VL2706-1UN40-□□□□	1	1 unit	1CC	3.100
	100	40 ... 100	1.25 ... $11 \times I_n$	1.5 ... $10 \times I_R$	0.4 ... $1 \times I_n$	3VL2710-1UN40-□□□□	1	1 unit	1CC	3.100
	160	64 ... 160	1.25 ... $11 \times I_n$	1.5 ... $10 \times I_R$	0.4 ... $1 \times I_n$	3VL2716-1UN40-□□□□	1	1 unit	1CC	3.100
VL250/3VL3	200	80 ... 200	1.25 ... $11 \times I_n$	1.5 ... $10 \times I_R$	0.4 ... $1 \times I_n$	3VL3720-1UN40-□□□□	1	1 unit	1CC	3.300
	250	100 ... 250	1.25 ... $11 \times I_n$	1.5 ... $10 \times I_R$	0.4 ... $1 \times I_n$	3VL3725-1UN40-□□□□	1	1 unit	1CC	3.300

Connection type can be selected by assignment of the 12th position of the Article No.

- Connection with box terminal
- Connection with flat screw terminal¹⁾

3
6

VL400/3VL4	315	128 ... 315	1.25 ... $11 \times I_n$	1.5 ... $10 \times I_R$	0.4 ... $1 \times I_n$	3VL4731-1UN46-□□□□	1	1 unit	1CC	7.600
	400	160 ... 400	1.25 ... $11 \times I_n$	1.5 ... $10 \times I_R$	0.4 ... $1 \times I_n$	3VL4740-1UN46-□□□□	1	1 unit	1CC	7.600
VL630/3VL5	630	252 ... 630	1.25 ... $10 \times I_n$	1.5 ... $9 \times I_R$	0.4 ... $1 \times I_n$	3VL5763-1UN46-□□□□	1	1 unit	1CC	11.700
VL800/3VL6	800	320 ... 800	1.25 ... $8 \times I_n$	1.5 ... $7 \times I_R$	0.4 ... $1 \times I_n$	3VL6780-1UN46-□□□□	1	1 unit	1CC	20.500
VL1250/3VL7	1000	400 ... 1000	1.25 ... $11 \times I_n$	1.5 ... $10 \times I_R$	0.4 ... $1 \times I_n$	3VL7710-1UN46-□□□□	1	1 unit	1CC	33.500
	1250	500 ... 1250	1.25 ... $11 \times I_n$	1.5 ... $10 \times I_R$	0.4 ... $1 \times I_n$	3VL7712-1UN46-□□□□	1	1 unit	1CC	33.500
VL1600/3VL8 ²⁾	1600	640 ... 1600	1.25 ... $9 \times I_n$	1.5 ... $8 \times I_R$	0.4 ... $1 \times I_n$	3VL8716-1UN40-□□□□	1	1 unit	1CC	40.800

¹⁾ When the circuit breaker with flat screw terminal is ordered, the basic price is reduced.

²⁾ Front busbar connection pieces are included in the scope of supply and are to be fitted by the customer.

Molded Case Circuit Breakers

3VL Molded Case Circuit Breakers up to 1600 A, IEC

4-pole

2

DT	I_{cu} up to 70 kA at 415 V, high breaking capacity H					(H)	DT	I_{cu} up to 100 kA at 415 V, very high breaking capacity L					(L)
Article No.	Basic price per PU	PU (UNIT, SET, M)	PS* / P. unit	PG	Weight per PU approx.		Article No.	Basic price per PU	PU (UNIT, SET, M)	PS* / P. unit	PG	Weight per PU approx.	
Article No. supplement, see page 2/172; www.siemens.com/product?Article No.						kg	Article No. supplement, see page 2/172; www.siemens.com/product?Article No.						kg

3VL2706-2UN4□-□□□□	1	1 unit	1CC	3.100	3VL2706-3UN4□-□□□□	1	1 unit	1CC	3.100
3VL2710-2UN4□-□□□□	1	1 unit	1CC	3.100	3VL2710-3UN4□-□□□□	1	1 unit	1CC	3.100
3VL2716-2UN4□-□□□□	1	1 unit	1CC	3.100	3VL2716-3UN4□-□□□□	1	1 unit	1CC	3.100
3VL3720-2UN4□-□□□□	1	1 unit	1CC	3.300	3VL3720-3UN4□-□□□□	1	1 unit	1CC	3.300
3VL3725-2UN4□-□□□□	1	1 unit	1CC	3.300	3VL3725-3UN4□-□□□□	1	1 unit	1CC	3.300

3
6

3
6

3VL4731-2UN46-□□□□	1	1 unit	1CC	7.600	3VL4731-3UN46-□□□□	1	1 unit	1CC	7.600
3VL4740-2UN46-□□□□	1	1 unit	1CC	7.600	3VL4740-3UN46-□□□□	1	1 unit	1CC	7.600
3VL5763-2UN46-□□□□	1	1 unit	1CC	11.700	3VL5763-3UN46-□□□□	1	1 unit	1CC	11.700
3VL6780-2UN46-□□□□	1	1 unit	1CC	20.500	3VL6780-3UN46-□□□□	1	1 unit	1CC	20.500
3VL7710-2UN46-□□□□	1	1 unit	1CC	33.500	3VL7710-3UN46-□□□□	1	1 unit	1CC	33.500
3VL7712-2UN46-□□□□	1	1 unit	1CC	33.500	3VL7712-3UN46-□□□□	1	1 unit	1CC	33.500
3VL8716-2UN40-□□□□	1	1 unit	1CC	40.800	3VL8716-3UN40-□□□□	1	1 unit	1CC	40.800

Molded Case Circuit Breakers

3VL Molded Case Circuit Breakers up to 1600 A, IEC

4-pole

2

Type	Rated current I_n	Current setting of the inverse-time delayed overcurrent protection "L" I_R	Operating current of the instantaneous short-circuit protection "I" I_I	S function short-circuit protection (short-time delayed) S	DT	I_{cu} up to 55 kA at 415 V, standard breaking capacity N See "Overview".						
	A	A	A	A			Article No.	Price	PU (UNIT, SET, M)	PS*/P. unit	PG	Weight per PU approx. kg
							Article No. supplement, see page 2/172; www.siemens.com/product?Article No.					

4-pole, fixed-mounted, for line protection – generator protection, 63 A to 1600 A, Electronic Trip Units LSI

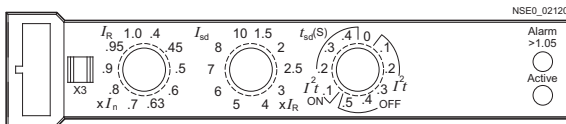

ETU20, LSI function for time-based discrimination

With adjustable overcurrent releases, non-adjustable short-circuit releases, short-circuit delay ($t_{sd} = 0 \dots 0.5$ s) Without overcurrent and short-circuit release in the 4th pole (N)

VL160/3VL2	63	25 ... 63	$11 \times I_n$	$1.5 \dots 10 \times I_R$	3VL2706-10040-0000	1	1 unit	1CC	3.100
	100	40 ... 100	$11 \times I_n$	$1.5 \dots 10 \times I_R$	3VL2710-10040-0000	1	1 unit	1CC	3.100
	160	64 ... 160	$11 \times I_n$	$1.5 \dots 10 \times I_R$	3VL2716-10040-0000	1	1 unit	1CC	3.100
VL250/3VL3	200	80 ... 200	$11 \times I_n$	$1.5 \dots 10 \times I_R$	3VL3720-10040-0000	1	1 unit	1CC	3.300
	250	100 ... 250	$11 \times I_n$	$1.5 \dots 10 \times I_R$	3VL3725-10040-0000	1	1 unit	1CC	3.300

Connection type can be selected by assignment of the 12th position of the Article No.

- Connection with box terminal
- Connection with flat screw terminal¹⁾

3
6

VL400/3VL4	315	128 ... 315	$11 \times I_n$	$1.5 \dots 10 \times I_R$	3VL4731-10046-0000	1	1 unit	1CC	7.600
	400	160 ... 400	$11 \times I_n$	$1.5 \dots 10 \times I_R$	3VL4740-10046-0000	1	1 unit	1CC	7.600
VL630/3VL5	630	252 ... 630	$10 \times I_n$	$1.5 \dots 9 \times I_R$	3VL5763-10046-0000	1	1 unit	1CC	11.700
VL800/3VL6	800	320 ... 800	$8 \times I_n$	$1.5 \dots 7 \times I_R$	3VL6780-10046-0000	1	1 unit	1CC	20.500
VL1250/3VL7	1000	400 ... 1000	$11 \times I_n$	$1.5 \dots 10 \times I_R$	3VL7710-10046-0000	1	1 unit	1CC	33.500
	1250	500 ... 1250	$11 \times I_n$	$1.5 \dots 10 \times I_R$	3VL7712-10046-0000	1	1 unit	1CC	33.500
VL1600/3VL8 ¹⁾	1600	640 ... 1600	$9 \times I_n$	$1.5 \dots 8 \times I_R$	3VL8716-10040-0000	1	1 unit	1CC	40.800

- Without communication preparation
- With communication preparation

TE
NE

4-pole, fixed-mounted, for line protection – generator protection, 63 A to 1600 A, Electronic Trip Units LSIN

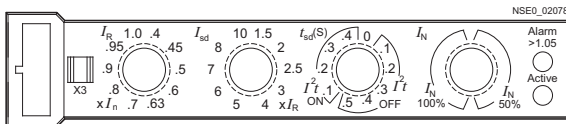

ETU20, LSIN function for time-based discrimination

With adjustable overcurrent releases, non-adjustable short-circuit releases, short-circuit delay ($t_{sd} = 0 \dots 0.5$ s) with overcurrent and short-circuit release in the 4th pole (N), N protection = 50/100 %

VL160/3VL2	63	$0.4 \dots 1.0 \times I_n$	$11 \times I_n$	$1.5 \dots 10 \times I_R$	3VL2706-10040-0000	1	1 unit	1CC	3.100
	100	$0.4 \dots 1.0 \times I_n$	$11 \times I_n$	$1.5 \dots 10 \times I_R$	3VL2710-10040-0000	1	1 unit	1CC	3.100
	160	$0.4 \dots 1.0 \times I_n$	$11 \times I_n$	$1.5 \dots 10 \times I_R$	3VL2716-10040-0000	1	1 unit	1CC	3.100
VL250/3VL3	200	$0.4 \dots 1.0 \times I_n$	$11 \times I_n$	$1.5 \dots 10 \times I_R$	3VL3720-10040-0000	1	1 unit	1CC	3.300
	250	$0.4 \dots 1.0 \times I_n$	$11 \times I_n$	$1.5 \dots 10 \times I_R$	3VL3725-10040-0000	1	1 unit	1CC	3.300

Connection type can be selected by assignment of the 12th position of the Article No.

- Connection with box terminal
- Connection with flat screw terminal¹⁾

3
6

VL400/3VL4	315	$0.4 \dots 1.0 \times I_n$	$11 \times I_n$	$1.5 \dots 10 \times I_R$	3VL4731-10046-0000	1	1 unit	1CC	7.600
	400	$0.4 \dots 1.0 \times I_n$	$11 \times I_n$	$1.5 \dots 10 \times I_R$	3VL4740-10046-0000	1	1 unit	1CC	7.600
VL630/3VL5	630	$0.4 \dots 1.0 \times I_n$	$10 \times I_n$	$1.5 \dots 9 \times I_R$	3VL5763-10046-0000	1	1 unit	1CC	11.700
VL800/3VL6	800	$0.4 \dots 1.0 \times I_n$	$8 \times I_n$	$1.5 \dots 7 \times I_R$	3VL6780-10046-0000	1	1 unit	1CC	20.500
VL1250/3VL7	1000	$0.4 \dots 1.0 \times I_n$	$11 \times I_n$	$1.5 \dots 10 \times I_R$	3VL7710-10046-0000	1	1 unit	1CC	33.500
	1250	$0.4 \dots 1.0 \times I_n$	$11 \times I_n$	$1.5 \dots 10 \times I_R$	3VL7712-10046-0000	1	1 unit	1CC	33.500
VL1600/3VL8 ²⁾	1600	$0.4 \dots 1.0 \times I_n$	$9 \times I_n$	$1.5 \dots 8 \times I_R$	3VL8716-10040-0000	1	1 unit	1CC	40.800

- Without communication preparation
- With communication preparation
- Marine engineering-certified LRS, DNV, GL and BV (not communication-ready)

TF
NF
LF

¹⁾ When the circuit breaker with flat screw terminal is ordered, the basic price is reduced.

²⁾ Front busbar connection pieces are included in the scope of supply and are to be fitted by the customer.

Communication:

- For accessories, see page 2/207.
- For more information, see also chapter "Measuring Devices and Power Monitoring" and chapter "Software".

Molded Case Circuit Breakers

3VL Molded Case Circuit Breakers up to 1600 A, IEC

4-pole

2

DT	I_{cu} up to 70 kA at 415 V, high breaking capacity H	(H)	DT	I_{cu} up to 100 kA at 415 V, very high breaking capacity L	(L)						
Article No.	Price	PU (UNIT, SET, M)	PS*/P. unit	PG	Weight per PU approx.	Article No.	Price	PU (UNIT, SET, M)	PS*/P. unit	PG	Weight per PU approx.
Article No. supplement, see page 2/172; www.siemens.com/product?Article.No.						Article No. supplement, see page 2/172; www.siemens.com/product?Article.No.					
kg						kg					

3VL2706-2□□4□-□□□□	1	1 unit	1CC	3.100	3VL2706-3□□4□-□□□□	1	1 unit	1CC	3.100
3VL2710-2□□4□-□□□□	1	1 unit	1CC	3.100	3VL2710-3□□4□-□□□□	1	1 unit	1CC	3.100
3VL2716-2□□4□-□□□□	1	1 unit	1CC	3.100	3VL2716-3□□4□-□□□□	1	1 unit	1CC	3.100
3VL3720-2□□4□-□□□□	1	1 unit	1CC	3.300	3VL3720-3□□4□-□□□□	1	1 unit	1CC	3.300
3VL3725-2□□4□-□□□□	1	1 unit	1CC	3.300	3VL3725-3□□4□-□□□□	1	1 unit	1CC	3.300
3 6					3 6				
3VL4731-2□□46-□□□□	1	1 unit	1CC	7.600	3VL4731-3□□46-□□□□	1	1 unit	1CC	7.600
3VL4740-2□□46-□□□□	1	1 unit	1CC	7.600	3VL4740-3□□46-□□□□	1	1 unit	1CC	7.600
3VL5763-2□□46-□□□□	1	1 unit	1CC	11.700	3VL5763-3□□46-□□□□	1	1 unit	1CC	11.700
3VL6780-2□□46-□□□□	1	1 unit	1CC	20.500	3VL6780-3□□46-□□□□	1	1 unit	1CC	20.500
3VL7710-2□□46-□□□□	1	1 unit	1CC	33.500	3VL7710-3□□46-□□□□	1	1 unit	1CC	33.500
3VL7712-2□□46-□□□□	1	1 unit	1CC	33.500	3VL7712-3□□46-□□□□	1	1 unit	1CC	33.500
3VL8716-2□□40-□□□□	1	1 unit	1CC	40.800	3VL8716-3□□40-□□□□	1	1 unit	1CC	40.800
TE NE					TE NE				

3VL2706-2□□4□-□□□□	1	1 unit	1CC	3.100	3VL2706-3□□4□-□□□□	1	1 unit	1CC	3.100
3VL2710-2□□4□-□□□□	1	1 unit	1CC	3.100	3VL2710-3□□4□-□□□□	1	1 unit	1CC	3.100
3VL2716-2□□4□-□□□□	1	1 unit	1CC	3.100	3VL2716-3□□4□-□□□□	1	1 unit	1CC	3.100
3VL3720-2□□4□-□□□□	1	1 unit	1CC	3.300	3VL3720-3□□4□-□□□□	1	1 unit	1CC	3.300
3VL3725-2□□4□-□□□□	1	1 unit	1CC	3.300	3VL3725-3□□4□-□□□□	1	1 unit	1CC	3.300
3 6					3 6				
3VL4731-2□□46-□□□□	1	1 unit	1CC	7.600	3VL4731-3□□46-□□□□	1	1 unit	1CC	7.600
3VL4740-2□□46-□□□□	1	1 unit	1CC	7.600	3VL4740-3□□46-□□□□	1	1 unit	1CC	7.600
3VL5763-2□□46-□□□□	1	1 unit	1CC	11.700	3VL5763-3□□46-□□□□	1	1 unit	1CC	11.700
3VL6780-2□□46-□□□□	1	1 unit	1CC	20.500	3VL6780-3□□46-□□□□	1	1 unit	1CC	20.500
3VL7710-2□□46-□□□□	1	1 unit	1CC	33.500	3VL7710-3□□46-□□□□	1	1 unit	1CC	33.500
3VL7712-2□□46-□□□□	1	1 unit	1CC	33.500	3VL7712-3□□46-□□□□	1	1 unit	1CC	33.500
3VL8716-2□□40-□□□□	1	1 unit	1CC	40.800	3VL8716-3□□40-□□□□	1	1 unit	1CC	40.800
TF NF LF					TF NF LF				

Molded Case Circuit Breakers

3VL Molded Case Circuit Breakers up to 1600 A, IEC

4-pole

2

Type	Rated current I_n	Current setting of the inverse-time delayed overcurrent protection "L" I_R	Operating current of the instantaneous short-circuit protection "I" I_i	S function short-circuit protection (short-time delayed)	Ground-fault protection "G" I_g	DT	I_{cu} up to 55 kA at 415 V, standard breaking capacity N See "Overview".	(N)				
	A	A	A	A	A		Article No. Article No. supplement, see page 2/172; www.siemens.com/product?ArticleNo.	Price	PU (UNIT, SET, M)	PS*/P. unit	PG	Weight per PU approx. kg

4-pole, fixed-mounted, for line protection – generator protection, 63 A to 1600 A, Electronic Trip Units LSING

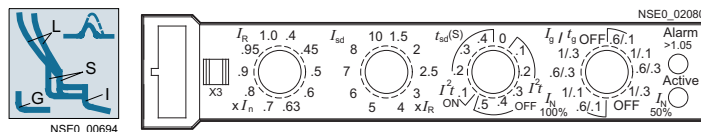

ETU22, LSING function for 4-wire three-phase systems and time-based discrimination

With adjustable overcurrent releases, adjustable short-circuit releases, ground fault delay $t_g = 0.1 \dots 0.3$ s, ground-fault protection (G) can be switched off, short-circuit delay $t_{sd} = 0 \dots 0.5$ s with overcurrent and short-circuit release in the 4th pole (N), N protection = 50/100 %

VL160/3VL2	63	25 ... 63	$11 \times I_n$	$1.5 \dots 10 \times I_R$	$0.6 \dots 1 \times I_n$, OFF	3VL2706-10040-0000	1	1 unit	1CC	3.100
	100	40 ... 100	$11 \times I_n$	$1.5 \dots 10 \times I_R$	$0.6 \dots 1 \times I_n$, OFF	3VL2710-10040-0000	1	1 unit	1CC	3.100
	160	64 ... 160	$11 \times I_n$	$1.5 \dots 10 \times I_R$	$0.6 \dots 1 \times I_n$, OFF	3VL2716-10040-0000	1	1 unit	1CC	3.100
VL250/3VL3	200	80 ... 200	$11 \times I_n$	$1.5 \dots 10 \times I_R$	$0.6 \dots 1 \times I_n$, OFF	3VL3720-10040-0000	1	1 unit	1CC	3.300
	250	100 ... 250	$11 \times I_n$	$1.5 \dots 10 \times I_R$	$0.6 \dots 1 \times I_n$, OFF	3VL3725-10040-0000	1	1 unit	1CC	3.300

Connection type can be selected by assignment of the 12th position of the Article No.

- Connection with box terminal
- Connection with flat screw terminal¹⁾

3
6

VL400/3VL4	315	128 ... 315	$11 \times I_n$	$1.5 \dots 10 \times I_R$	$0.6 \dots 1 \times I_n$, OFF	3VL4731-10046-0000	1	1 unit	1CC	7.600
	400	160 ... 400	$11 \times I_n$	$1.5 \dots 10 \times I_R$	$0.6 \dots 1 \times I_n$, OFF	3VL4740-10046-0000	1	1 unit	1CC	7.600
VL630/3VL5	630	252 ... 630	$10 \times I_n$	$1.5 \dots 9 \times I_R$	$0.6 \dots 1 \times I_n$, OFF	3VL5763-10046-0000	1	1 unit	1CC	11.700
VL800/3VL6	800	320 ... 800	$8 \times I_n$	$1.5 \dots 7 \times I_R$	$0.6 \dots 1 \times I_n$, OFF	3VL6780-10046-0000	1	1 unit	1CC	20.500
VL1250/3VL7	1000	400 ... 1000	$11 \times I_n$	$1.5 \dots 10 \times I_R$	$0.6 \dots 1 \times I_n$, OFF	3VL7710-10046-0000	1	1 unit	1CC	33.500
	1250	500 ... 1250	$11 \times I_n$	$1.5 \dots 10 \times I_R$	$0.6 \dots 1 \times I_n$, OFF	3VL7712-10046-0000	1	1 unit	1CC	33.500
VL1600/3VL8 ²⁾	1600	640 ... 1600	$9 \times I_n$	$1.5 \dots 8 \times I_R$	$0.6 \dots 1 \times I_n$, OFF	3VL8716-10040-0000	1	1 unit	1CC	40.800

- Without communication preparation
- With communication preparation

TH
NH

¹⁾ When the circuit breaker with flat screw terminal is ordered, the basic price is reduced.

²⁾ Front busbar connection pieces are included in the scope of supply and are to be fitted by the customer.

Communication:

- For accessories, see page 2/207.
- For more information, see also chapter "Measuring Devices and Power Monitoring" and chapter "Software".

Molded Case Circuit Breakers

3VL Molded Case Circuit Breakers up to 1600 A, IEC

4-pole

2

DT	I_{cu} up to 70 kA at 415 V, high breaking capacity H					(H)	DT	I_{cu} up to 100 kA at 415 V, very high breaking capacity L					(L)		
	Article No.	Price	PU (UNIT, SET, M)	PS*/P. unit	PG	Weight per PU approx.		Article No.	Price	PU (UNIT, SET, M)	PS*/P. unit	PG	Weight per PU approx.		
	Article No. supplement, see page 2/172; www.siemens.com/product?Article No.						kg		Article No. supplement, see page 2/172; www.siemens.com/product?Article No.						kg

3VL2706-2□□4□-□□□□	1	1 unit	1CC	3.100			3VL2706-3□□4□-□□□□	1	1 unit	1CC	3.100		
3VL2710-2□□4□-□□□□	1	1 unit	1CC	3.100			3VL2710-3□□4□-□□□□	1	1 unit	1CC	3.100		
3VL2716-2□□4□-□□□□	1	1 unit	1CC	3.100			3VL2716-3□□4□-□□□□	1	1 unit	1CC	3.100		
3VL3720-2□□4□-□□□□	1	1 unit	1CC	3.300			3VL3720-3□□4□-□□□□	1	1 unit	1CC	3.300		
3VL3725-2□□4□-□□□□	1	1 unit	1CC	3.300			3VL3725-3□□4□-□□□□	1	1 unit	1CC	3.300		

3
6

3
6

3VL4731-2□□46-□□□□	1	1 unit	1CC	7.600			3VL4731-3□□46-□□□□	1	1 unit	1CC	7.600		
3VL4740-2□□46-□□□□	1	1 unit	1CC	7.600			3VL4740-3□□46-□□□□	1	1 unit	1CC	7.600		
3VL5763-2□□46-□□□□	1	1 unit	1CC	11.700			3VL5763-3□□46-□□□□	1	1 unit	1CC	11.700		
3VL6780-2□□46-□□□□	1	1 unit	1CC	20.500			3VL6780-3□□46-□□□□	1	1 unit	1CC	20.500		
3VL7710-2□□46-□□□□	1	1 unit	1CC	33.500			3VL7710-3□□46-□□□□	1	1 unit	1CC	33.500		
3VL7712-2□□46-□□□□	1	1 unit	1CC	33.500			3VL7712-3□□46-□□□□	1	1 unit	1CC	33.500		
3VL8716-2□□40-□□□□	1	1 unit	1CC	40.800			3VL8716-3□□40-□□□□	1	1 unit	1CC	40.800		

TH
NH

TH
NH

Molded Case Circuit Breakers

3VL Molded Case Circuit Breakers up to 1600 A, IEC

4-pole

2

Type	Rated current I_n	Operating current of the instantaneous short-circuit releases "I" I_i	DT	I_{cu} up to 55 kA at 415 V, standard breaking capacity N See "Overview".	(N)
	A	A		Article No. Article No. supplement, see page 2/172; www.siemens.com/ product?ArticleNo	Basic price per PU PU (UNIT, SET, M) PS*/ P. unit PG Weight per PU approx. kg

4-pole, fixed-mounted, for safe disconnection,
100 A to 1600 A, magnetic trip units I

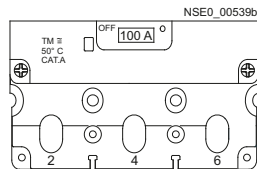

Non-automatic molded case circuit breakers¹⁾, I function

Without overcurrent releases, with non-adjustable short-circuit releases (for intrinsic protection only),
without overcurrent and short-circuit release in the 4th pole (N)

VL160X/3VL1	100 160	1800 1800	3VL1710-1EE40-□□□□ 3VL1716-1EE40-□□□□	1 1	1 unit 1 unit	1CC 1CC	2.500 2.500
VL160/3VL2	100 160	2500 2500	3VL2710-1EE40-□□□□ 3VL2716-1EE40-□□□□	1 1	1 unit 1 unit	1CC 1CC	3.000 3.000
VL250/3VL3	250	3500	3VL3725-1EE40-□□□□	1	1 unit	1CC	3.200

Connection type can be selected by assignment of the 12th position of the Article No.

- Connection with box terminal
- Connection with screw terminal not in conjunction with RCD module at 3VL1²⁾

3
6

VL400/3VL4	400	4000	3VL4740-1EE46-□□□□	1	1 unit	1CC	7.400
VL630/3VL5	630	6300	3VL5763-1EE46-□□□□	1	1 unit	1CC	11.200
VL800/3VL6	800	6500	3VL6780-1EE46-□□□□	1	1 unit	1CC	19.900
VL1250/3VL7	1250	12000	3VL7712-1EE46-□□□□	1	1 unit	1CC	31.000
VL1600/3VL8 ³⁾	1600	14400	3VL8716-1EE40-□□□□	1	1 unit	1CC	38.300

- 1) See chapter "Switch Disconnectors". 3K. switch disconnectors are also available with rear-mounting operating mechanism and leading contacts.
- 2) When the circuit breaker with flat screw terminal is ordered, the basic price is reduced.
- 3) Front busbar connection pieces are included in the scope of supply and are to be fitted by the customer.

Molded Case Circuit Breakers

3VL Molded Case Circuit Breakers up to 1600 A, IEC

4-pole

2

DT I_{cu} up to 70 kA at 415 V, high breaking capacity H						(H)	DT I_{cu} up to 100 kA at 415 V, very high breaking capacity L						(L)
Article No.	Basic price per PU	PU (UNIT, SET, M)	PS*/P. unit	PG	Weight per PU approx. kg		Article No.	Basic price per PU	PU (UNIT, SET, M)	PS*/P. unit	PG	Weight per PU approx. kg	
3VL1710-2EE4□-□□□□		1	1 unit	1CC	2.500	--							
3VL1716-2EE4□-□□□□		1	1 unit	1CC	2.500	--							
3VL2710-2EE4□-□□□□		1	1 unit	1CC	3.000		3VL2710-3EE4□-□□□□		1	1 unit	1CC	3.000	
3VL2716-2EE4□-□□□□		1	1 unit	1CC	3.000		3VL2716-3EE4□-□□□□		1	1 unit	1CC	3.000	
3VL3725-2EE4□-□□□□		1	1 unit	1CC	3.200		3VL3725-3EE4□-□□□□		1	1 unit	1CC	3.200	
3							3						
6							6						
3VL4740-2EE46-□□□□		1	1 unit	1CC	7.400		3VL4740-3EE46-□□□□		1	1 unit	1CC	7.400	
3VL5763-2EE46-□□□□		1	1 unit	1CC	11.200		3VL5763-3EE46-□□□□		1	1 unit	1CC	11.200	
3VL6780-2EE46-□□□□		1	1 unit	1CC	19.900		3VL6780-3EE46-□□□□		1	1 unit	1CC	19.900	
3VL7712-2EE46-□□□□		1	1 unit	1CC	31.000		3VL7712-3EE46-□□□□		1	1 unit	1CC	31.000	
3VL8716-2EE40-□□□□		1	1 unit	1CC	38.300		3VL8716-3EE40-□□□□		1	1 unit	1CC	38.300	

Molded Case Circuit Breakers

3VL Molded Case Circuit Breakers up to 1600 A, IEC

4-pole

2

Article No. supplement (for complete Article No., see pages 2/156 to 2/144)	Breaking capacity	Type VL160 ¹⁾		VL250 ¹⁾		VL400		VL630	VL800	VL1250	VL1600		
		3VL2	3VL3	3VL4	3VL5	3VL6	3VL7	3VL8					
3VL7..-□□4-.....		Rated current I _n											
Trip unit		63 A	100 A	160 A	200 A	250 A	315 A	400 A	630 A	800 A	1000 A	1250 A	1600 A
Price													
ETU10	TB	N H L	✓	✓	✓	✓	✓	✓	✓	✓	✓	✓	✓
ETU10	NB	N H L	✓	✓	✓	✓	✓	✓	✓	✓	✓	✓	✓
ETU10	TA	N H L	✓	✓	✓	✓	✓	✓	✓	✓	✓	✓	✓
ETU10	NA	N H L	✓	✓	✓	✓	✓	✓	✓	✓	✓	✓	✓
ETU10	LA	N H L	✓	✓	✓	✓	✓	✓	✓	✓	✓	✓	✓
ETU12	TN	N H L	✓	✓	✓	✓	✓	✓	✓	✓	✓	✓	✓
ETU12	NN	N H L	✓	✓	✓	✓	✓	✓	✓	✓	✓	✓	✓
ETU40	UJ	N H L	✓	✓	✓	✓	✓	✓	✓	✓	✓	✓	✓
ETU42	UN	N H L	✓	✓	✓	✓	✓	✓	✓	✓	✓	✓	✓
ETU20	TE	N H L	✓	✓	✓	✓	✓	✓	✓	✓	✓	✓	✓
ETU20	NE	N H L	✓	✓	✓	✓	✓	✓	✓	✓	✓	✓	✓
ETU20	TF	N H L	✓	✓	✓	✓	✓	✓	✓	✓	✓	✓	✓
ETU20	NF	N H L	✓	✓	✓	✓	✓	✓	✓	✓	✓	✓	✓
ETU20	LF	N H L	✓	✓	✓	✓	✓	✓	✓	✓	✓	✓	✓
ETU22	TH	N H L	✓	✓	✓	✓	✓	✓	✓	✓	✓	✓	✓
ETU22	NH	N H L	✓	✓	✓	✓	✓	✓	✓	✓	✓	✓	✓

✓ Available

1) The basic price is reduced when the molded case circuit breaker is ordered with a flat screw terminal ".36-".

Equipment options for the insulated accessory compartments in the 3VL molded case circuit breakers

3-pole circuit breakers without communication preparation

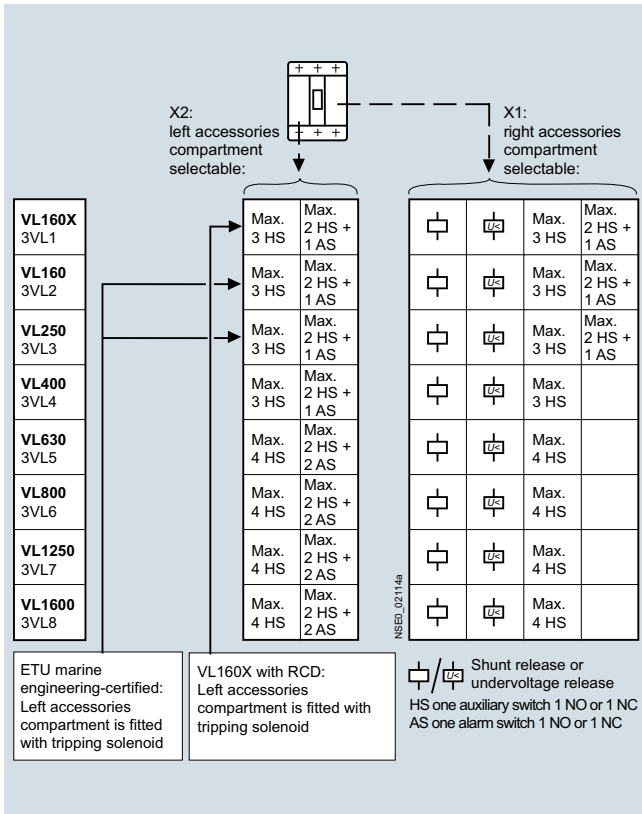

4-pole circuit breakers without communication preparation

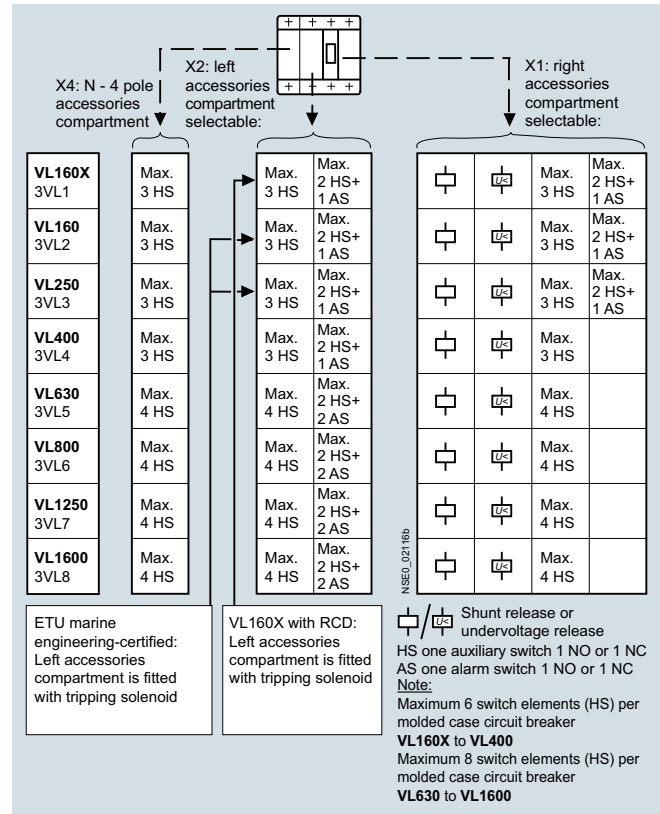

3-pole circuit breakers with communication preparation

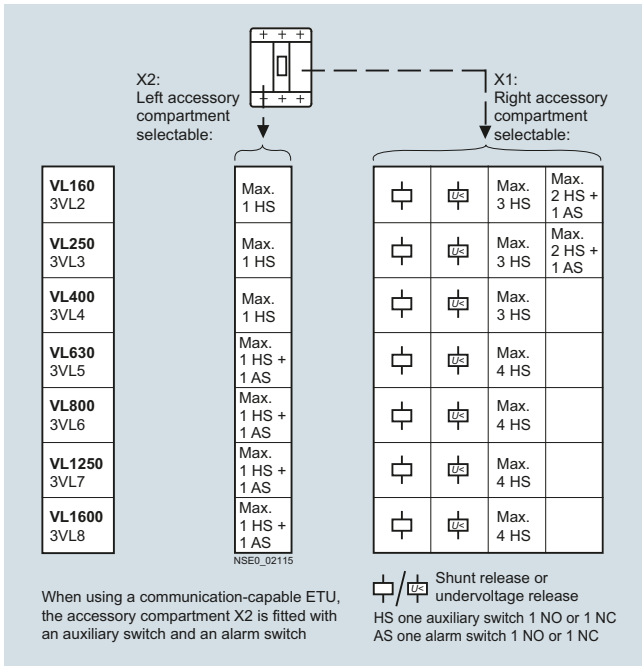

4-pole circuit breakers with communication preparation

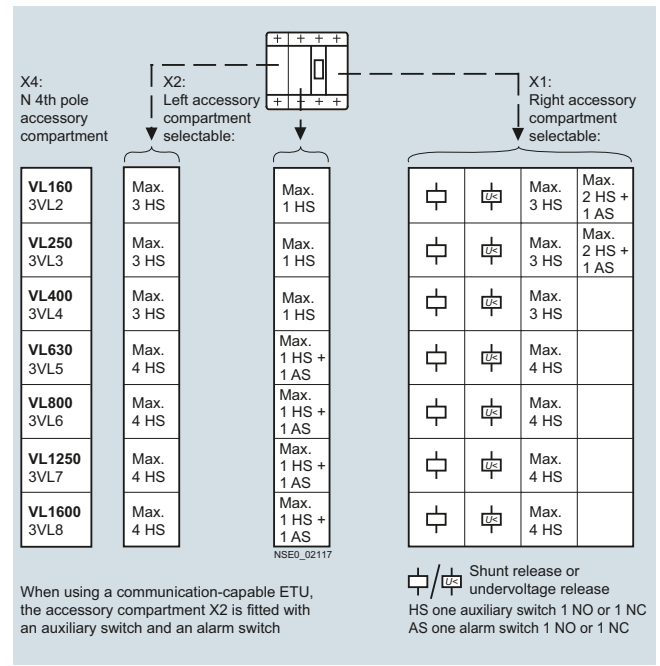

Note:

Before ordering, use the tables above to check whether the required combination of shunt releases, undervoltage releases and auxiliary/alarm switches is feasible.

Molded Case Circuit Breakers

3VL Molded Case Circuit Breakers up to 1600 A, IEC

Options

1st Article No. supplement: Undervoltage or shunt release, wiring directly to accessories

Rated control supply voltage U_s /frequency	Article No. supplement	Circuit breakers Type	Additional price
50/60 Hz AC DC	3VL.....-...- □ □ ..	VL160X to VL400/ 3VL1 to 3VL4	VL630 to VL1600/ 3VL5 to 3VL8
		Additional price	Additional price
3- or 4-pole			
Without auxiliary release		0 A	None
With undervoltage release			
Only right pole			
V AC	V DC		
--	12	2 N	✓
--	24	2 P	✓
--	48	2 U	✓
--	60	2 V	✓
--	110 ... 127	2 R	✓
--	220 ... 250	2 S	✓
24	--	2 D	✓
110 ... 127	--	2 G	✓
220 ... 250	--	2 H	✓
208	--	2 M	✓
277	--	2 Q	✓
380 ... 415	--	2 J	✓
440 ... 480	--	2 K	✓
500 ... 525	--	2 L	✓
With shunt release			
Only right pole			
V AC	V DC		
24	24	8 C	✓
--	48 ... 60	8 J	✓
--	110 ... 127	8 K	✓
--	220 ... 250	8 Q	✓
48 ... 60	--	8 M	✓
110 ... 127	--	8 R	✓
208 ... 277	--	8 T	✓
380 ... 600	--	8 V	✓

2nd Article No. supplement: Auxiliary switches (HS) and alarm switches (AS), left/right pole, directly wired to accessories

Equipment	Article No. supplement	Circuit breakers Type	Additional price
HS = 1 NO or 1 NC contact block AS = 1 NO contact block	3VL.....-...- .. □ □	VL160X to VL400 ¹⁾ / 3VL1 to 3VL4	VL630 to VL1600/ 3VL5 to 3VL8
		Additional price	Additional price
Without auxiliary/alarm switches		A 0	None
2 HS (1 NO/1 NC) ²⁾	B 1	✓ ¹⁾⁴⁾	--
4 HS (2 NO/2 NC)	C 1	✓	✓
2 HS (1 NO/1 NC) + 1 AS (1 NO)	D 1	✓ ¹⁾⁴⁾	--
2 HS (1 NO/1 NC) + 1 AS (1 NO) ³⁾	E 1	--	✓ ⁵⁾

✓ Additional price

-- Not available

1) Except for installation in the left accessory compartment of the VL160X molded case circuit breakers with RCD module.

2) With mounting adapter up to 3 HS.

3) With mounting adapter up to 2 HS + 2 AS.

4) Not feasible for use of marine engineering ETU and additional use of shunt and undervoltage releases.

When using a communication-capable ETU, the accessory compartment X2 is fitted with an auxiliary switch and an alarm switch. The combination of 1st and 2nd Article No. supplement is only possible with restrictions. It is recommended to use the configurator in the Mall for selection purposes.

5) Not possible when using a communication-capable ETU.

Selection and ordering data

When ordering, add "-Z" to the complete Article No. and add the relevant order code(s).	Article No. with "-Z" 1 2 3 4 5 6 7 8 9 10 11 12 13 14 15 16 3VL -Z and additional order code(s) <input type="checkbox"/> <input type="checkbox"/> + . . . + . . .	Additional price
---	---	------------------

Code for further versions -Z

For fixed-mounted circuit breakers (wired in factory)

3- or 4-pole

Description	Availability	Code	Price
Prewired internal accessories For VL160X to VL1600 (3VL1 to 3VL8) Connecting cables (3 m long) brought out at the rear This option "L02" can be selected only in combination with internal accessories (page 2/172).	For VL160X to VL1600 (3VL1 to 3VL8)	L 0 2	✓
Prewired connecting cables for motorized operating mechanisms with stored energy mechanisms (SEO) Connecting cables on the circuit breaker for motorized operating mechanisms (3 m long). On VL160X to VL400 brought out at the top. On VL630 and VL800 brought out on the right. Option "L12" can only be selected in combination with motorized operating mechanisms (order codes "M24", "M42", "M60", "M11" and "M22").	For VL160X to VL800 (3VL1 to 3VL6)	L 1 2	✓
Motorized operating mechanisms with stored energy mechanisms for synchronization tasks (24 V DC) Motorized operating mechanisms not prewired; if wiring for the motorized operating mechanism is wanted, please specify "L12" in addition. If internal accessories are provided, the prewiring option "L02" for internal accessories is already included. In this case "L02" must not be specified in addition.	Available with VL160X, VL160, VL250 (3VL1, 3VL2, 3VL3) VL400 (3VL4) VL630, VL800 (3VL5, 3VL6) VL1250, VL1600 (3VL7, 3VL8) ¹⁾	M 2 4	✓ ✓ ✓ ✓
Motorized operating mechanisms with stored energy mechanisms for synchronization tasks (42 ... 48 V AC/DC) Motorized operating mechanisms not prewired; if wiring for the motorized operating mechanism is wanted, please specify "L12" in addition. If internal accessories are provided, the prewiring option "L02" for internal accessories is already included. In this case "L02" must not be specified in addition.	Available with VL160X, VL160, VL250 (3VL1, 3VL2, 3VL3) VL400 (3VL4) VL630, VL800 (3VL5, 3VL6) VL1250, VL1600 (3VL7, 3VL8) ¹⁾	M 4 2	✓ ✓ ✓ ✓
Motorized operating mechanisms with stored energy mechanisms for synchronization tasks (60 V AC/DC) Motorized operating mechanisms not prewired; if wiring for the motorized operating mechanism is wanted, please specify "L12" in addition. If internal accessories are provided, the prewiring option "L02" for internal accessories is already included. In this case "L02" must not be specified in addition.	Available with VL160X, VL160, VL250 (3VL1, 3VL2, 3VL3) VL400 (3VL4) VL630, VL800 (3VL5, 3VL6) VL1250, VL1600 (3VL7, 3VL8) ¹⁾	M 6 0	✓ ✓ ✓ ✓
Motorized operating mechanisms with stored energy mechanisms for synchronization tasks (110 ... 127 V AC/DC) Motorized operating mechanisms not prewired; if wiring for the motorized operating mechanism is wanted, please specify "L12" in addition. If internal accessories are provided, the prewiring option "L02" for internal accessories is already included. In this case "L02" must not be specified in addition.	Available with VL160X, VL160, VL250 (3VL1, 3VL2, 3VL3) VL400 (3VL4) VL630, VL800 (3VL5, 3VL6) VL1250, VL1600 (3VL7, 3VL8) ¹⁾	M 1 1	✓ ✓ ✓ ✓
Motorized operating mechanisms with stored energy mechanisms for synchronization tasks (220 ... 250 V AC/DC) Motorized operating mechanisms not prewired; if wiring for the motorized operating mechanism is wanted, please specify "L12" in addition. If internal accessories are provided, the prewiring option "L02" for internal accessories is already included. In this case "L02" must not be specified in addition.	Available with VL160X, VL160, VL250 (3VL1, 3VL2, 3VL3) VL400 (3VL4) VL630, VL800 (3VL5, 3VL6) VL1250, VL1600 (3VL7, 3VL8) ¹⁾	M 2 2	✓ ✓ ✓ ✓

✓ Additional price

¹⁾ The motorized operating mechanism for VL1250 and VL1600 (3VL7 and 3VL8) has no stored energy mechanism and is also unsuitable for synchronization tasks.

Molded Case Circuit Breakers

3VL Molded Case Circuit Breakers up to 1600 A, IEC

Options

2

When ordering, add "-Z" to the complete Article No. and add the relevant order code(s).

Article No. with "-Z"

Additional price

1 2 3 4 5 6 7 8 9 10 11 12 13 14 15 16

3VL -Z
and additional order code(s)

+ . . . + . . .

Code for further versions -Z

For fixed-mounted circuit breakers (wired in factory)

3- or 4-pole

Pre-mounted motorized operating mechanisms (24 V DC) on circuit breaker, not synchronizable	Available with VL160X (3VL1)	M 2 5	✓
If internal accessories are provided, the prewiring option "L02" for internal accessories is already included. In this case "L02" must not be specified in addition.	VL160, VL250 (3VL2, 3VL3)		✓
	VL400 (3VL4)		✓
	VL630, VL800 (3VL5, 3VL6)		✓
Pre-mounted motorized operating mechanisms (42 ... 60 V AC/DC) on circuit breaker, not synchronizable	Available with VL160X (3VL1)	M 4 3	✓
If internal accessories are provided, the prewiring option "L02" for internal accessories is already included. In this case "L02" must not be specified in addition.	VL160, VL250 (3VL2, 3VL3)		✓
	VL400 (3VL4)		✓
	VL630, VL800 (3VL5, 3VL6)		✓
Pre-mounted motorized operating mechanisms (110 ... 127 V AC/DC) on circuit breaker, not synchronizable	Available with VL160X (3VL1)	M 1 2	✓
If internal accessories are provided, the prewiring option "L02" for internal accessories is already included. In this case "L02" must not be specified in addition.	VL160, VL250 (3VL2, 3VL3)		✓
	VL400 (3VL4)		✓
	VL630, VL800 (3VL5, 3VL6)		✓
Pre-mounted motorized operating mechanisms (220 ... 250 V AC/DC) on circuit breaker, not synchronizable	Available with VL160X (3VL1)	M 2 3	✓
If internal accessories are provided, the prewiring option "L02" for internal accessories is already included. In this case "L02" must not be specified in addition.	VL160, VL250 (3VL2, 3VL3)		✓
	VL400 (3VL4)		✓
	VL630, VL800 (3VL5, 3VL6)		✓

✓ Additional price

Selection and ordering data

Wiring directly to accessories	DT	For VL160X to VL400 (3VL1 to 3VL4)	PU (UNIT, SET, M)	PS*/P. unit	PG	Weight per PU approx.
		Article No. www.siemens.com/product?Article.No.	Price per PU			kg

Auxiliary switches and auxiliary releases

3- or 4-pole

For retrofitting (for equipment options, see Technical Information at www.siemens.com/lowvoltage/product-support.)

Auxiliary switches (HS) and alarm switches (AS)

For retrofitting

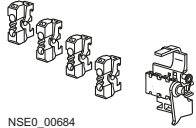

NSE0_00684
3VL9400-2A.00

Assembly kits	Mounting side					
2 HS (1 NO + 1 NC)	N, left ¹⁾ , right	3VL9400-2AB00	1	1 unit	1CC	0.056
4 HS (2 NO + 2 NC)	N, left ¹⁾ , right	--				
2 HS (1 NC + 1 NO)	left ¹⁾ , right ³⁾	3VL9400-2AD00	1	1 unit	1CC	0.087
+ 1 AS (1 NO) (assembly kit)	left ¹⁾	--				

Additional auxiliary switch/alarm switch combinations

See page 2/177.

Shunt releases²⁾

For retrofitting

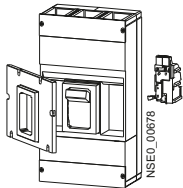

3VL9400-1S.00,
3VL9400-1U.00

V AC	V DC	Mounting side				
24	24	Right pole only	3VL9400-1SC00	1	1 unit	1CC 0.100
--	48 ... 60	Right pole only	3VL9400-1SJ00	1	1 unit	1CC 0.103
--	110 ... 127	Right pole only	3VL9400-1SK00	1	1 unit	1CC 0.099
--	220 ... 250	Right pole only	3VL9400-1SQ00	1	1 unit	1CC 0.098
48 ... 60	--	Right pole only	3VL9400-1SM00	1	1 unit	1CC 0.103
110 ... 127	--	Right pole only	3VL9400-1SR00	1	1 unit	1CC 0.101
208 ... 277	--	Right pole only	3VL9400-1ST00	1	1 unit	1CC 0.100
380 ... 600	--	Right pole only	3VL9400-1SV00	1	1 unit	1CC 0.106

Undervoltage releases

For retrofitting

V AC	V DC	Mounting side				
--	12	Right pole only	3VL9400-1UN00	1	1 unit	1CC 0.100
--	24	Right pole only	3VL9400-1UP00	1	1 unit	1CC 0.099
--	48	Right pole only	3VL9400-1UU00	1	1 unit	1CC 0.100
--	60	Right pole only	3VL9400-1UV00	1	1 unit	1CC 0.098
24	--	Right pole only	3VL9400-1UD00	1	1 unit	1CC 0.104
110 ... 127	--	Right pole only	3VL9400-1UG00	1	1 unit	1CC 0.104
--	110 ... 127	Right pole only	3VL9400-1UR00	1	1 unit	1CC 0.099
208	--	Right pole only	3VL9400-1UM00	1	1 unit	1CC 0.103
220 ... 250	--	Right pole only	3VL9400-1UH00	1	1 unit	1CC 0.105
--	220 ... 250	Right pole only	3VL9400-1US00	1	1 unit	1CC 0.102
277	--	Right pole only	3VL9400-1UQ00	1	1 unit	1CC 0.100
380 ... 415	--	Right pole only	3VL9400-1UJ00	1	1 unit	1CC 0.103
440 ... 480	--	Right pole only	3VL9400-1UK00	1	1 unit	1CC 0.103
500 ... 525	--	Right pole only	3VL9400-1UL00	1	1 unit	1CC 0.103

Time-delay devices for undervoltage releases

(220 ... 250 V DC)

Rated control supply voltage U_s

220 ... 250 V AC

Delay time > 200 ms

3TX4701-0AN1	1	1 unit	41B	0.168
------------------------------	---	--------	-----	-------

Storage devices for shunt releases
(208 ... 277 V AC/220 ... 250 V DC)

Rated control supply voltage U_s

220 V ... 240 V AC/220 V ... 250 V DC

Storage time 5 min

3WL9111-0BA14-0AA0	1	1 unit	1CA	0.520
------------------------------------	---	--------	-----	-------

- 1) Except for installation in the left accessory compartment of the VL160X (3VL1) molded case circuit breakers with RCD module.
- 2) Shunt releases with disconnection contact (3SB3 for ON/OFF position) not floating (see Technical Information at www.siemens.com/lowvoltage/product-support).
- 3) In the case of VL400 (3VL4):
Unsuitable for mounting in the right-hand accessory compartment.
The 3VL9400-2AB00 assembly kit with auxiliary switches only is recommended.

Molded Case Circuit Breakers

3VL Molded Case Circuit Breakers up to 1600 A, IEC

Accessories and spare parts

2

Wiring directly to accessories	DT	For VL630 up to VL1600 (3VL5 to 3VL8)	PU (UNIT, SET, M)	PS*/P. unit	PG	Weight per PU approx. kg
		Article No. www.siemens.com/product?ArticleNo.	Price per PU			

Auxiliary switches and auxiliary releases

3- or 4-pole

For retrofitting (for equipment options, see Technical Information at www.siemens.com/lowvoltage/product-support.)

Auxiliary switches (HS) and alarm switches (AS)

For retrofitting

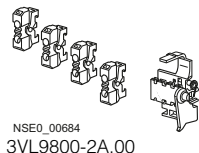

Assembly kits	Mounting side					
2 HS (1 NO + 1 NC)	N, left, right	--				
4 HS (2 NO + 2 NC)	N, left, right	3VL9800-2AC00	1	1 unit	1CC	0.090
2 HS (1 NC + 1 NO) + 1 AS (1 NO) (assembly kit)	Left, right Left	3VL9800-2AE00	1	1 unit	1CC	0.080

Additional auxiliary switch/alarm switch combinations

See page 2/177.

Shunt releases¹⁾

For retrofitting

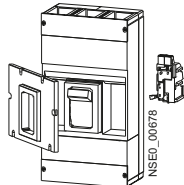

V AC	V DC	Mounting side				
24	24	Right pole only	3VL9800-1SC00	1	1 unit	1CC 0.151
--	48 ... 60	Right pole only	3VL9800-1SJ00	1	1 unit	1CC 0.150
--	110 ... 127	Right pole only	3VL9800-1SK00	1	1 unit	1CC 0.153
--	220 ... 250	Right pole only	3VL9800-1SQ00	1	1 unit	1CC 0.150
48 ... 60	--	Right pole only	3VL9800-1SM00	1	1 unit	1CC 0.150
110 ... 127	--	Right pole only	3VL9800-1SR00	1	1 unit	1CC 0.155
208 ... 277	--	Right pole only	3VL9800-1ST00	1	1 unit	1CC 0.149
380 ... 600	--	Right pole only	3VL9800-1SV00	1	1 unit	1CC 0.150

Undervoltage releases

For retrofitting

V AC	V DC	Mounting side				
--	12	Right pole only	3VL9800-1UN00	1	1 unit	1CC 0.123
--	24	Right pole only	3VL9800-1UP00	1	1 unit	1CC 0.119
--	48	Right pole only	3VL9800-1UU00	1	1 unit	1CC 0.114
--	60	Right pole only	3VL9800-1UV00	1	1 unit	1CC 0.115
24	--	Right pole only	3VL9800-1UD00	1	1 unit	1CC 0.118
110 ... 127	--	Right pole only	3VL9800-1UG00	1	1 unit	1CC 0.114
--	110 ... 127	Right pole only	3VL9800-1UR00	1	1 unit	1CC 0.115
208	--	Right pole only	3VL9800-1UM00	1	1 unit	1CC 0.114
220 ... 250	--	Right pole only	3VL9800-1UH00	1	1 unit	1CC 0.114
--	220 ... 250	Right pole only	3VL9800-1US00	1	1 unit	1CC 0.114
277	--	Right pole only	3VL9800-1UQ00	1	1 unit	1CC 0.121
380 ... 415	--	Right pole only	3VL9800-1UJ00	1	1 unit	1CC 0.112
440 ... 480	--	Right pole only	3VL9800-1UK00	1	1 unit	1CC 0.115
500 ... 525	--	Right pole only	3VL9800-1UL00	1	1 unit	1CC 0.116

Time-delay devices for undervoltage releases (220 ... 250 V DC)

Rated control supply voltage U_s
220 ... 250 V AC

Delay time > 200 ms

3TX4701-0AN1	1	1 unit	41B	0.168
--------------	---	--------	-----	-------

Storage devices for shunt releases (208 ... 277 V AC/220 ... 250 V DC)

Rated control supply voltage U_s
220 V ... 240 V AC/220 V ... 250 V DC

Storage time 5 min

3WL9111-0BA14-0AA0	1	1 unit	1CA	0.520
--------------------	---	--------	-----	-------

¹⁾ Shunt releases with disconnection contact (3SB3 for ON/OFF position) not floating (see Technical Information at www.siemens.com/lowvoltage/product-support).

For circuit breakers	Maximum combination of auxiliary switches (HS) and alarm switches (AS)	DT	Article No. www.siemens.com/product?Article No.	Price per PU	PU (UNIT, SET, M)	PS*/P. unit	PG	Weight per PU approx. kg
----------------------	--	----	--	--------------	-------------------	-------------	----	-----------------------------

3SB adapters and 3SB contact blocks

Mounting adapters for auxiliary and alarm switch combinations

For installation in the N pole of the circuit breaker

VL160X, VL160, VL250, VL400 (3VL1 to 3VL4)	Up to 3 HS ¹⁾ 2 HS + 1 AS ¹⁾²⁾		3VL9400-2AH00 --		1	1 unit	1CC	0.038
VL630, VL800, VL1250, VL1600 (3VL5 to 3VL8)	Up to 4 HS 2 HS + 2 AS		3VL9816-2AL00 --		1	1 unit	1CC	0.053

For installation in the left pole of the circuit breaker

VL160X, VL160, VL250, VL400 (3VL1 to 3VL4)	Up to 3 HS ¹⁾ 2 HS + 1 AS ¹⁾²⁾		3VL9400-2AH00 3VL9400-2AJ10		1	1 unit	1CC	0.038
VL630, VL800, VL1250, VL1600 (3VL5 to 3VL8)	Up to 4 HS 2 HS + 2 AS		3VL9816-2AL00 3VL9816-2AN10		1	1 unit	1CC	0.053

For installation in the right pole of the circuit breaker

VL160X, VL160, VL250, VL400 (3VL1 to 3VL4) ²⁾	Up to 3 HS ¹⁾ 2 HS + 1 AS ¹⁾²⁾		3VL9400-2AH00 3VL9400-2AJ20		1	1 unit	1CC	0.038
VL630, VL800, VL1250, VL1600 (3VL5 to 3VL8)	Up to 4 HS 2 HS + 2 AS		3VL9816-2AL00 --		1	1 unit	1CC	0.053

¹⁾ Except for installing in the left pole for VL160X (3VL1) molded case circuit breakers with RCD module.

²⁾ In the case of VL400: 3VL9400-2AJ20 unsuitable for mounting in the right-hand accessory compartment.

For auxiliary switches (HS) and alarm switches (AS)	DT	Circuit breakers Type VL160X to VL1600 (3VL1 to 3VL8)	PU (UNIT, SET, M)	PS*/P. unit	PG	Weight per PU approx. kg
---	----	---	-------------------	-------------	----	-----------------------------

Contact blocks for auxiliary switch (HS) and alarm switch (AS) combinations

1 NO		3SB3400-0J	1	1 unit	41J	0.009
1 NC		3SB3400-0K	1	1 unit	41J	0.009

For auxiliary switch or alarm switch combinations not included in the kits provided as standard, the mounting adapters specified can be ordered separately together with the required contact blocks:

- 1 HS or 1 AS with NO contact 3SB3400-0J
- 1 HS or 1 AS with NC contact 3SB3400-0K

Note:

A maximum of 6 contact blocks (HS) per circuit breaker (VL160X, VL160, VL250, VL400; 3VL1 to 3VL4) and a maximum of 8 contact blocks (HS) per circuit breaker (VL630, VL800, VL1250, VL1600; 3VL5 to 3VL8) are possible.

Four 3SB34 auxiliary contact blocks and one mounting adapter (right), suitable for VL630, VL800, VL1250, VL1600 (3VL5 to 3VL8) circuit breakers.

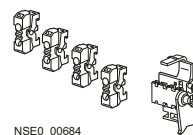

NSE0_00684



For retrofitting/equipment options, see Technical Information at www.siemens.com/lowvoltage/product-support.

Molded Case Circuit Breakers

3VL Molded Case Circuit Breakers up to 1600 A, IEC

Accessories and spare parts

2

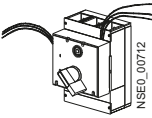
Version	DT	For VL160X to VL250 (3VL1 to 3VL3)	PU (UNIT, SET, M)	PS*/P. unit	PG	Weight per PU approx. kg
		Article No. www.siemens.com/product?ArticleNo.	Price per PU			
Manual operating mechanisms						
3- or 4-pole						
	Front-operated rotary operating mechanisms¹⁾ For direct mounting on the circuit breaker, without leading auxiliary switch, degree of protection IP30 ²⁾ , black, max. 3 padlocks		3VL9300-3HA00	1	1 unit	1CC 0.534
	<u>EMERGENCY-STOP version</u> Red knob, yellow indicator plate Safety locks for installation by the customer, see pages 2/200 to 2/204.		3VL9300-3HC00	1	1 unit	1CC 0.500
	Front-operated rotary operating mechanisms with shaft stub, without knob¹⁾ Without leading auxiliary switch, for auxiliary switches, see below.		3VL9300-3HE00	1	1 unit	1CC 0.411
	Door-coupling rotary operating mechanisms, complete¹⁾ Installation in doors and covers Degree of protection IP65, including handle ti-grey, with masking plate, indicator plate, removable door coupling (die cast with reduced tolerance compensation), extension shaft (8 x 8 mm), length 300 mm and front-operated rotary operating mechanism for the respective circuit breaker, lockable with up to 3 padlocks, with door interlocking		3VL9300-3HF05	1	1 unit	1CC 0.800
	<u>EMERGENCY-STOP version</u> Red knob, yellow indicator plate, without leading auxiliary switch Safety locks for installation by the customer, see pages 2/200 to 2/204.		3VL9300-3HG05	1	1 unit	1CC 0.800
	Leading auxiliary switches for installation in a front-operated rotary operating mechanism, door-coupling rotary operating mechanism or side panel rotary operating mechanism Standard or EMERGENCY-STOP version					
	"OFF after ON" Leading auxiliary switches when switching on		3VL9300-3AS10	1	1 unit	1CC 0.113
	2 changeover contact with 1.5 m long cables		3VL9300-3AT10	1	1 unit	1CC 0.183
	"ON after OFF" Leading auxiliary switches when switching off		3VL9300-3AU10	1	1 unit	1CC 0.119
2 changeover contact with 1.5 m long cables		3VL9300-3AW10	1	1 unit	1CC 0.189	
Side panel rotary operating mechanisms, complete¹⁾						
Degree of protection IP65, including black knob with masking plate, indicator plate, Bowden wire, lockable with up to 3 padlocks						
- With 600 mm Bowden wire		3VL9300-3HR10	1	1 unit	1CC 1.758	
- With 1000 mm Bowden wire		3VL9300-3HR20	1	1 unit	1CC 2.100	
- With 1500 mm Bowden wire		3VL9300-3HR30	1	1 unit	1CC 1.900	
Side panel rotary operating mechanisms, complete¹⁾						
<u>EMERGENCY-STOP version</u>						
Degree of protection IP65, including red knob with masking plate, yellow indicator plate, Bowden wire, lockable with up to 3 padlocks						
- With 600 mm Bowden wire		3VL9300-3HR11	1	1 unit	1CC 2.100	
- With 1000 mm Bowden wire		3VL9300-3HR21	1	1 unit	1CC 2.100	
- With 1500 mm Bowden wire		3VL9300-3HR31	1	1 unit	1CC 2.100	
Retaining brackets, suitable for matching door-coupling rotary operating mechanisms, complete with locking device						
Retaining bracket is mounted on the operating mechanism, recommended for extension shafts > 250 mm						
- For 6 mm shaft		3VL9300-3HP02	1	1 unit	1CC 0.409	
		3VL9300-3HP00	1	1 unit	1CC 0.385	

Additional accessories and components for door-coupling rotary operating mechanism, [see pages 2/183 and 2/185.](#)

¹⁾ Not possible on VL160X with RCD module.

²⁾ IP40 with additional masking frame mounted on the door cutout

Molded Case Circuit Breakers

3VL Molded Case Circuit Breakers up to 1600 A, IEC

Accessories and spare parts

2



DT	For VL400 (3VL4)	Price per PU	PU (UNIT, SET, M)	PS*/P. unit	PG	Weight per PU approx. kg	DT	For VL630 (3VL5)	Price per PU	PU (UNIT, SET, M)	PS*/P. unit	PG	Weight per PU approx. kg
	Article No. www.siemens.com/product?Article No.							Article No. www.siemens.com/product?Article No.					
	3VL9400-3HA00		1	1 unit	1CC	1.281		3VL9600-3HA00		1	1 unit	1CC	1.373
	3VL9400-3HC00		1	1 unit	1CC	1.291		3VL9600-3HC00		1	1 unit	1CC	1.404
	3VL9400-3HE00		1	1 unit	1CC	1.126		3VL9600-3HE00		1	1 unit	1CC	1.154
	3VL9400-3HF05		1	1 unit	1CC	1.510		3VL9600-3HF05		1	1 unit	1CC	1.660
	3VL9400-3HG05		1	1 unit	1CC	1.569		3VL9600-3HG05		1	1 unit	1CC	1.640
	3VL9400-3AS10		1	1 unit	1CC	0.098		3VL9600-3AS10		1	1 unit	1CC	0.109
	3VL9400-3AT10		1	1 unit	1CC	0.181		3VL9600-3AT10		1	1 unit	1CC	0.178
	3VL9400-3AU10		1	1 unit	1CC	0.114		3VL9600-3AU10		1	1 unit	1CC	0.111
	3VL9400-3AW10		1	1 unit	1CC	0.185		3VL9600-3AW10		1	1 unit	1CC	0.181
	3VL9400-3HR10		1	1 unit	1CC	2.640		3VL9500-3HR10		1	1 unit	1CC	2.675
	3VL9400-3HR20		1	1 unit	1CC	2.657		3VL9500-3HR20		1	1 unit	1CC	2.852
	3VL9400-3HR30		1	1 unit	1CC	2.525		3VL9500-3HR30		1	1 unit	1CC	2.852
	3VL9400-3HR11		1	1 unit	1CC	2.619		3VL9500-3HR11		1	1 unit	1CC	2.870
	3VL9400-3HR21		1	1 unit	1CC	2.660		3VL9500-3HR21		1	1 unit	1CC	2.889
	3VL9400-3HR31		1	1 unit	1CC	3.500		3VL9500-3HR31		1	1 unit	1CC	2.940
	3VL9400-3HP00		1	1 unit	1CC	0.516		3VL9600-3HP00		1	1 unit	1CC	0.562
	--							--					

Molded Case Circuit Breakers

3VL Molded Case Circuit Breakers up to 1600 A, IEC

Accessories and spare parts

2

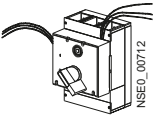
Version	DT	For VL800 (3VL6)	Price per PU	PU (UNIT, SET, M)	PS*/P. unit	PG	Weight per PU approx. kg
Manual operating mechanisms							
3- or 4-pole							
 3VL9.00-3H.00	Front-operated rotary operating mechanisms For direct mounting on the circuit breaker, without leading auxiliary switch, degree of protection IP30 ¹⁾ , <u>black</u> , max. 3 padlocks EMERGENCY-STOP version Red knob, yellow indicator plate Safety locks for installation by the customer, see pages 2/200 to 2/204 .		Article No. www.siemens.com/product?Article No.				
			3VL9600-3HA00 3VL9600-3HC00	1	1 unit	1CC	1.373 1.404
 3VL9.00-3H.05	Front-operated rotary operating mechanisms with shaft stub, without knob Without leading auxiliary switch, for auxiliary switches, see below .						1.154
 3VL9.00-3H.05	Door-coupling rotary operating mechanisms, complete Installation in doors and covers Degree of protection IP65, including handle, <u>ti-grey</u> , with masking plate, indicator plate, detachable door coupling (die cast, for VL800 (3VL6) with reduced tolerance compensation), extension shaft (8 x 8 mm for VL800 (3VL6), 12 x 12 mm for VL1250 (3VL7) and VL1600 (3VL8), length 300 mm and front-operated rotary operating mechanism for the respective circuit breaker, lockable with max. 3 padlocks, with door interlocking EMERGENCY-STOP version, Red knob, yellow indicator plate, without leading auxiliary switch Safety locks for installation by the customer, see pages 2/200 to 2/204 .						
			3VL9600-3HF05 3VL9600-3HG05	1	1 unit	1CC	1.660 1.640
 3VL9.00-3A.10	Leading auxiliary switches for installation in a front-operated rotary operating mechanism or door-coupling rotary operating mechanism Standard or EMERGENCY-STOP version "OFF after ON" Leading auxiliary switches when switching on 1 changeover contact with 1.5 m long cables 2 changeover contacts with 1.5 m long cables "ON after OFF" Leading auxiliary switches when switching off 1 changeover contact with 1.5 m long cables 2 changeover contacts with 1.5 m long cables						
			3VL9600-3AS10 3VL9600-3AT10	1	1 unit	1CC	0.109 0.178
			3VL9600-3AU10 3VL9600-3AW10	1	1 unit	1CC	0.111 0.181
			Retaining brackets, suitable for matching door-coupling rotary operating mechanisms, complete with locking device Retaining bracket is mounted on the operating mechanism, recommended for extension shafts > 250 mm				
		3VL9600-3HP00	1	1 unit	1CC	0.562	

Additional accessories and components for door-coupling rotary operating mechanism, [see pages 2/183 and 2/185](#).

¹⁾ IP40 with additional masking frame mounted on the door cutout.

DT	For VL1250 to VL1600 (3VL7 to 3VL8)	Price per PU	PU (UNIT, SET, M)	PS*/ P. unit	PG	Weight per PU approx. kg
----	--	-----------------	-------------------------	-----------------	----	---------------------------------------

	3VL9800-3HA00		1	1 unit	1CC	3.562
	3VL9800-3HC00		1	1 unit	1CC	3.580
	3VL9800-3HE00		1	1 unit	1CC	2.859
	3VL9800-3HF05		1	1 unit	1CC	3.940
	3VL9800-3HG05		1	1 unit	1CC	3.980
	3VL9800-3AS20		1	1 unit	1CC	0.150
	3VL9800-3AT20		1	1 unit	1CC	0.203
	3VL9800-3AU10		1	1 unit	1CC	0.120
	3VL9800-3AW10		1	1 unit	1CC	0.192
	3VL9800-3HP00		1	1 unit	1CC	0.630

Molded Case Circuit Breakers

3VL Molded Case Circuit Breakers up to 1600 A, IEC

Accessories and spare parts

2

Version	DT	Article No. www.siemens.com/ product?Article No.	Price per PU	PU (UNIT, SET, M)	PS*/ P. unit	PG	Weight per PU approx. kg
---------	----	--	-----------------	-------------------------	-----------------	----	-----------------------------------

Motorized operating mechanisms

3- or 4-pole

Motorized operating mechanisms with stored energy mechanisms (SEO) for synchronization tasks¹⁾²⁾

Degree of protection IP30, with locking device for 3 padlocks



3VL9.00-3M.00

50/60 Hz V AC	V DC						
--	24	3VL9300-3MJ00	1	1 unit	1CC	2.755	
42 ... 48	42 ... 48	3VL9300-3ML00	1	1 unit	1CC	2.810	
60	60	3VL9300-3MS00	1	1 unit	1CC	2.773	
110 ... 127	110 ... 127	3VL9300-3MN00	1	1 unit	1CC	2.782	
220 ... 250	220 ... 250	3VL9300-3MQ00	1	1 unit	1CC	2.802	

For VL160X to VL250 (3VL1 to 3VL3)

50/60 Hz V AC	V DC						
--	24	3VL9400-3MJ00	1	1 unit	1CC	4.610	
42 ... 48	42 ... 48	3VL9400-3ML00	1	1 unit	1CC	4.594	
60	60	3VL9400-3MS00	1	1 unit	1CC	4.596	
110 ... 127	110 ... 127	3VL9400-3MN00	1	1 unit	1CC	4.602	
220 ... 250	220 ... 250	3VL9400-3MQ00	1	1 unit	1CC	4.593	

For VL400 (3VL4)

50/60 Hz V AC	V DC						
--	24	3VL9600-3MJ00	1	1 unit	1CC	5.630	
42 ... 48	42 ... 48	3VL9600-3ML00	1	1 unit	1CC	5.486	
60	60	3VL9600-3MS00	1	1 unit	1CC	5.662	
110 ... 127	110 ... 127	3VL9600-3MN00	1	1 unit	1CC	5.473	
220 ... 250	220 ... 250	3VL9600-3MQ00	1	1 unit	1CC	5.639	

For VL630 and VL800 (3VL5 and 3VL6)



3VL9.00-3M.10

Motorized operating mechanisms (MO)¹⁾

Degree of protection IP30, with locking device for 3 padlocks

50/60 Hz V AC	V DC						
--	24	3VL9100-3MA10	1	1 unit	1CC	1.807	
42 ... 60	42 ... 60	3VL9100-3MC10	1	1 unit	1CC	1.790	
110 ... 127	110 ... 127	3VL9100-3MD10	1	1 unit	1CC	1.770	
220 ... 250	220 ... 250	3VL9100-3ME10	1	1 unit	1CC	1.802	

For VL160X (3VL1)

50/60 Hz V AC	V DC						
--	24	3VL9300-3MA10	1	1 unit	1CC	1.800	
42 ... 60	42 ... 60	3VL9300-3MC10	1	1 unit	1CC	1.799	
110 ... 127	110 ... 127	3VL9300-3MD10	1	1 unit	1CC	1.797	
220 ... 250	220 ... 250	3VL9300-3ME10	1	1 unit	1CC	1.805	

For VL160 and VL250 (3VL2 and 3VL3)

50/60 Hz V AC	V DC						
--	24	3VL9400-3MA10	1	1 unit	1CC	2.298	
42 ... 60	42 ... 60	3VL9400-3MC10	1	1 unit	1CC	2.330	
110 ... 127	110 ... 127	3VL9400-3MD10	1	1 unit	1CC	2.320	
220 ... 250	220 ... 250	3VL9400-3ME10	1	1 unit	1CC	2.325	

For VL400 (3VL4)

50/60 Hz V AC	V DC						
--	24	3VL9600-3MA10	1	1 unit	1CC	2.310	
42 ... 60	42 ... 60	3VL9600-3MC10	1	1 unit	1CC	2.261	
110 ... 127	110 ... 127	3VL9600-3MD10	1	1 unit	1CC	2.329	
220 ... 250	220 ... 250	3VL9600-3ME10	1	1 unit	1CC	2.332	

For VL630 and VL800 (3VL5 and 3VL6)

50/60 Hz V AC	V DC						
--	24	3VL9800-3MJ00	1	1 unit	1CC	7.910	
42 ... 48	42 ... 48	3VL9800-3ML00	1	1 unit	1CC	7.945	
60	60	3VL9800-3MS00	1	1 unit	1CC	7.945	
110 ... 127	110 ... 127	3VL9800-3MN00	1	1 unit	1CC	7.861	
220 ... 250	220 ... 250	3VL9800-3MQ00	1	1 unit	1CC	7.865	

For VL1250 and VL1600²⁾ (3VL7 and 3VL8)

Toggle lever extension

Toggle lever extension



- For VL400 (3VL4)
- For VL630 and VL800 (3VL5 and 3VL6)
- For VL1250 and VL1600 (3VL7 and 3VL8)

For VL400 up to VL1600 (3VL4 to 3VL8)

3VL9400-3HN00	1	1 unit	1CC	0.023
3VL9600-3HN00	1	1 unit	1CC	0.027
3VL9800-3HN00	1	1 unit	1CC	0.251



¹⁾ Not possible on VL160X with RCD module.

²⁾ For safety lock as an assembly kit for retrofitting see pages 2/200 to 2/204.

Switching devices	Rotary operating mechanisms	Size	Cross-section of the actuating shaft	Version ¹⁾	DT	Individual parts for 8UC7 door-coupling rotary operating mechanisms	PU (UNIT, SET, M)	PS*/P. unit	PG	Weight per PU approx.
Type	Type		mm × mm			Article No. www.siemens.com/product?Article No.	Price per PU			kg
Individual parts for 8UC door-coupling rotary operating mechanisms²⁾										
Handles with masking plate (including flat gasket and fixing screws)										
	3VL1, 3VL2, 3VL3	8UC71	1	6 × 6 or 8 × 8	Standard EMERGENCY-STOP	8UC7110-6BD 8UC7120-8BD		1 unit	1CL	0.185
8UC7110-1BB								1 unit	1CL	0.183
	3VL4, 3VL5, 3VL6	8UC72	2	8 × 8	Standard EMERGENCY-STOP	8UC7210-6BD 8UC7220-8BD		1 unit	1CL	0.200
8UC7210-6BD								1 unit	1CL	0.194
	3VL7, 3VL8	8UC73	3	12 × 12	Standard EMERGENCY-STOP	8UC7310-6BD 8UC7320-8BD		1 unit	1CL	0.508
8UC7310-1BB								1 unit	1CL	0.488

¹⁾ Standard: Ti-grey handle, light-gray masking plate; EMERGENCY-STOP: Red handle, yellow masking plate.

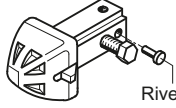
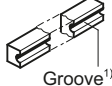
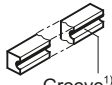
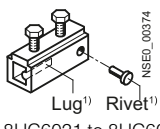
²⁾ Cannot be used for side panel rotary operating mechanisms

Rotary operating mechanisms	Cross-section of the actuating shaft	DT	Individual parts for 8UC6 door-coupling rotary operating mechanisms	PU (UNIT, SET, M)	PS*/P. unit	PG	Weight per PU approx.
Type	mm × mm		Article No. www.siemens.com/product?Article No.	Price per PU			kg
Individual parts for 8UC door-coupling rotary operating mechanisms							
Coupling drivers for 3VL							
	8UC71 (plastic)	6 × 6	8UC7011-2AA		1 unit	1CL	0.051
8UC6014	8UC71/8UC72 ²⁾ (die cast)	8 × 8	8UC6017-2AA		1 unit	1CL	0.047
	8UC73/74 (die cast)	12 × 12	8UC6014		1 unit	1CL	0.234
Extension shafts 300 mm long							
	8UC71	6 × 6	8UC6031		1 unit	1CL	0.068
8UC6031	8UC71/8UC72	8 × 8	8UC6032		1 unit	1CL	0.135
	8UC73	10 × 10	8UC6033		1 unit	1CL	0.215
	8UC73/74	12 × 12	8UC6034		1 unit	1CL	0.316
Extension shafts 600 mm long							
	8UC71	6 × 6	8UC6081		1 unit	1CL	0.136
8UC6081	8UC71/8UC72	8 × 8	8UC6082		1 unit	1CL	0.265
	8UC73	10 × 10	8UC6083		1 unit	1CL	0.424
	8UC73/74	12 × 12	8UC6084		1 unit	1CL	0.628
Shaft couplings							
	8UC71	6 × 6	8UC6021		1 unit	1CL	0.027
8UC6021 to 8UC6024	8UC72	8 × 8	8UC6022		1 unit	1CL	0.022
	8UC73	10 × 10	8UC6023		1 unit	1CL	0.084
	8UC73/74	12 × 12	8UC6024		1 unit	1CL	0.078
Reducers							
	8UC71	8 × 8 to 6 × 6	8UC7058		1 unit	1CL	0.024
8UC7058	8UC72	12 × 12 to 8 × 8	8UC7050		1 unit	1CL	0.080

¹⁾ Non-interchangeability features.

²⁾ Shortened coupling driver with reduced tolerance compensation.

Molded Case Circuit Breakers

3VL Molded Case Circuit Breakers up to 1600 A, IEC



Accessories and spare parts



2

Switching devices	Rated current	Cross-section of the actuating shaft	Torque	Rotary operating mechanisms	Illustrated: Handle, masking plate
Type	A	mm	Nm	Size	

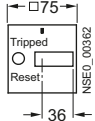
8UC door-coupling rotary operating mechanisms

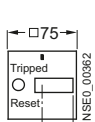

8UC71 – 3VL circuit breakers

	3VL1	16 ... 160	6 × 6	4	1	
	3VL2	50 ... 160	6 × 6	4		
	3VL3	200... 250	6 × 6	4		

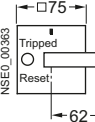

	3VL1	16 ... 160	8 × 8	4	1	
	3VL2	50 ... 160	8 × 8	4		
	3VL3	200... 250	8 × 8	4		

(Supplied with door-coupling rotary operating mechanism, complete 3VL9300-3H.05)

8UC72 – 3VL circuit breakers

	3VL4	200 ... 400	8 × 8	9	2	
	3VL5	315 ... 600	8 × 8	9		
	3VL6	320 ... 800	8 × 8	9		

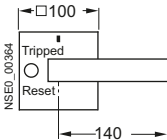
8UC73 – 3VL circuit breakers

	3VL7	400 ... 1250	12 × 12	25	3	
	3VL8	640 ... 1600	12 × 12	25		

1) Requires in addition a front-operated rotary operating mechanism with shaft stub for direct mounting to the circuit breaker. For ordering the complete operating mechanism, see pages 2/178 to 2/181.

Molded Case Circuit Breakers

3VL Molded Case Circuit Breakers up to 1600 A, IEC

Accessories and spare parts

2

Version	DT	Rotary operating mechanisms, complete ¹⁾	PU (UNIT, SET, M)	PS*/P. unit	PG	Weight per PU approx.	Individual parts of the rotary operating mechanism				
							Handle with masking plate	Coupling drivers	Extension shaft (length 300 mm)	Reducer/shaft coupling	
Standard: Ti-grey handle, light-grey masking plate EMERGENCY-STOP: Red handle, yellow masking plate		Article No. www.siemens.com/product?ArticleNo.	Price per PU				kg Article No.	Article No.	Article No.	Article No.	
Standard EMERGENCY-STOP (coupling driver made of plastic)		8UC7111-6BD15 8UC7121-8BD15		1	1 unit	1CL	0.359	8UC7110-6BD	□ 6 mm 8UC7011-2AA	□ 6 mm 8UC6031	□ 8 mm by 6 mm 8UC7058
				1	1 unit	1CL	0.336	8UC7120-8BD	8UC7011-2AA	8UC6031	8UC7058
Standard EMERGENCY-STOP (Die cast coupling driver with reduced tolerance compensation)		8UC7162-6BD22 8UC7172-8BD22		1	1 unit	1CL	0.415	8UC7110-6BD	□ 8 mm 8UC6017-2AA	□ 8 mm 8UC6032	□ 8 mm by 8 mm 8UC6022
				1	1 unit	1CL	0.416	8UC7120-8BD	8UC6017-2AA	8UC6032	8UC6022
Standard EMERGENCY-STOP (Die cast coupling driver with reduced tolerance compensation)		8UC7262-6BD26 8UC7262-8BD26		1	1 unit	1CL	0.486	8UC7210-6BD	□ 8 mm 8UC6017-2AA	□ 8 mm 8UC6032	□ 12 mm by 8 mm 8UC7050
				1	1 unit	1CL	0.486	8UC7220-8BD	8UC6017-2AA	8UC6032	8UC7050
Standard EMERGENCY-STOP (Die cast coupling driver)		8UC7314-6BD44 8UC7324-8BD44		1	1 unit	1CL	1.120	8UC7310-6BD	□ 12 mm 8UC6014	□ 12 mm 8UC6034	□ 12 mm by 12 mm 8UC6024
				1	1 unit	1CL	1.124	8UC7320-8BD	8UC6014	8UC6034	8UC6024

Molded Case Circuit Breakers

3VL Molded Case Circuit Breakers up to 1600 A, IEC

Accessories and spare parts

2

Version	DT	For VL160X (3VL1) Article No. www.siemens.com/ product?Article.No.	Price per PU	PU (UNIT, SET, M)	PS*/ P. unit	PG	Weight per PU approx. kg
Plug-in versions/withdrawable versions							
3- or 4-pole							
Plug-in base assembly kits Base, blade contacts for circuit breakers, terminal covers for degree of protection IP20, fixing screws, trip pin							
Rear terminals							
		3VL9100-4PA30		1	1 unit	1CC	2.490
		3VL9100-4PB30		1	1 unit	1CC	2.839
		3VL9100-4PA40		1	1 unit	1CC	3.272
		3VL9100-4PB40		1	1 unit	1CC	3.622
90° angle connecting adapters							
		3VL9300-4PE30		1	1 unit	1CC	0.452
		3VL9300-4PE40		1	1 unit	1CC	0.548
Front-accessible connections							
		3VL9100-4PC30		1	1 unit	1CC	2.291
		3VL9100-4PD30		1	1 unit	1CC	2.624
		3VL9100-4PC40		1	1 unit	1CC	2.942
		3VL9100-4PD40		1	1 unit	1CC	3.502
Withdrawable version assembly kits Upgrade of the plug-in base assembly kit to							
Withdrawable version including side panels and racking mechanism.	3-pole	--					
	3-pole with RCD	--					
	4-pole	--					
	4-pole with RCD	--					
Withdrawable versions Same as plug-in base assembly kit, with additional side panels and racking mechanism							
Rear terminals							
	3-pole	--					
	3-pole with RCD module	--					
	4-pole	--					
	4-pole with RCD module	--					
Front-accessible connections							
	3-pole	--					
	3-pole with RCD module	--					
	4-pole	--					
	4-pole with RCD module	--					
Blade contacts As replacement for converting fixed-mounted circuit breakers into plug-in/withdrawable circuit breakers, including trip pin							
	1 set = 6 units	3-pole	3VL9100-4PS30	1	1 unit	1CC	0.312
	1 set = 8 units	4-pole	3VL9100-4PS40	1	1 unit	1CC	0.396
Trip pins and springs As replacement for plug-in/withdrawable circuit breaker							
			3VL9100-4PF00	1	1 unit	1CC	0.010
Auxiliary circuit plug connections for plug-in bases Accessory connections for plug-in circuit breakers (factory-wired connectors) and for plug-in bases or withdrawable version (coupling with screw terminal)							
	8 terminals		1) 3VL9300-4PJ00	1	1 unit	1CC	0.196
Position signaling switches (Connected/disconnected position) For plug-in/withdrawable base, 1 changeover contact, max. 2 signaling switches possible							
			3VL9000-4WL00	1	1 unit	1CC	0.037



3VL9.00-4PA30



3VL9.00-4WA30



3VL9.00-4WA30

1) It is recommended to use a maximum of 2 auxiliary circuit plug-in systems per circuit breaker (16 terminals).

Molded Case Circuit Breakers

3VL Molded Case Circuit Breakers up to 1600 A, IEC

Accessories and spare parts

2

DT	For VL160 (3VL2)	Price per PU	PU (UNIT, SET, M)	PS*/P. unit	PG	Weight per PU approx. kg	DT	For VL250 (3VL3)	Price per PU	PU (UNIT, SET, M)	PS*/P. unit	PG	Weight per PU approx. kg
	Article No. www.siemens.com/product?Article No.							Article No. www.siemens.com/product?Article No.					
	3VL9200-4PA30		1	1 unit	1CC	2.504		3VL9300-4PA30		1	1 unit	1CC	2.606
	3VL9200-4PB30		1	1 unit	1CC	2.991		3VL9300-4PB30		1	1 unit	1CC	3.120
	3VL9200-4PA40		1	1 unit	1CC	3.120		3VL9300-4PA40		1	1 unit	1CC	3.409
	3VL9200-4PB40		1	1 unit	1CC	3.614		3VL9300-4PB40		1	1 unit	1CC	3.762
	3VL9300-4PE30		1	1 unit	1CC	0.452		3VL9300-4PE30		1	1 unit	1CC	0.452
	3VL9300-4PE40		1	1 unit	1CC	0.548		3VL9300-4PE40		1	1 unit	1CC	0.548
	3VL9200-4PC30		1	1 unit	1CC	2.254		3VL9300-4PC30		1	1 unit	1CC	2.400
	3VL9200-4PD30		1	1 unit	1CC	2.368		3VL9300-4PD30		1	1 unit	1CC	2.668
	3VL9200-4PC40		1	1 unit	1CC	2.920		3VL9300-4PC40		1	1 unit	1CC	3.010
	3VL9200-4PD40		1	1 unit	1CC	3.395		3VL9300-4PD40		1	1 unit	1CC	3.500
	3VL9300-4WF30		1	1 unit	1CC	2.360		3VL9300-4WF30		1	1 unit	1CC	2.360
	3VL9300-4WG30		1	1 unit	1CC	2.740		3VL9300-4WG30		1	1 unit	1CC	2.740
	3VL9300-4WF40		1	1 unit	1CC	2.740		3VL9300-4WF40		1	1 unit	1CC	2.740
	3VL9300-4WG40		1	1 unit	1CC	3.015		3VL9300-4WG40		1	1 unit	1CC	3.015
	3VL9200-4WA30		1	1 unit	1CC	4.940		3VL9300-4WA30		1	1 unit	1CC	5.192
	3VL9200-4WB30		1	1 unit	1CC	6.301		3VL9300-4WB30		1	1 unit	1CC	9.800
	3VL9200-4WA40		1	1 unit	1CC	5.662		3VL9300-4WA40		1	1 unit	1CC	5.932
	3VL9200-4WB40		1	1 unit	1CC	6.919		3VL9300-4WB40		1	1 unit	1CC	6.935
	3VL9200-4WC30		1	1 unit	1CC	4.987		3VL9300-4WC30		1	1 unit	1CC	5.100
	3VL9200-4WD30		1	1 unit	1CC	6.045		3VL9300-4WD30		1	1 unit	1CC	6.249
	3VL9200-4WC40		1	1 unit	1CC	5.560		3VL9300-4WC40		1	1 unit	1CC	5.560
	3VL9200-4WD40		1	1 unit	1CC	6.732		3VL9300-4WD40		1	1 unit	1CC	6.895
	3VL9200-4PS30		1	1 unit	1CC	0.303		3VL9300-4PS30		1	1 unit	1CC	0.424
	3VL9200-4PS40		1	1 unit	1CC	0.381		3VL9300-4PS40		1	1 unit	1CC	0.535
	3VL9300-4PF00		1	1 unit	1CC	0.006		3VL9300-4PF00		1	1 unit	1CC	0.006
	1) 3VL9300-4PJ00		1	1 unit	1CC	0.196		1) 3VL9300-4PJ00		1	1 unit	1CC	0.196
	3VL9000-4WL00		1	1 unit	1CC	0.037		3VL9000-4WL00		1	1 unit	1CC	0.037

Molded Case Circuit Breakers

3VL Molded Case Circuit Breakers up to 1600 A, IEC

Accessories and spare parts

2

Version	DT	For VL400 (3VL4)	Price per PU	PU (UNIT, SET, M)	PS*/P. unit	PG	Weight per PU approx. kg
Plug-in versions/withdrawable versions							
3- or 4-pole							
Plug-in base assembly kits							
Base, blade contacts for circuit breakers, terminal covers for degree of protection IP20, fixing screws, trip pin							
Rear terminals							
		3VL9400-4PA30 --1)		1	1 unit	1CC	6.520
		3VL9400-4PA40		1	1 unit	1CC	8.380
		3VL9400-4PB40		1	1 unit	1CC	9.857
90° angle connecting adapters							
For rear connection, 3-pole							
For rear connection, 4-pole							
Front-accessible connections							
		3VL9400-4PC30 --1)		1	1 unit	1CC	6.190
		3VL9400-4PC40		1	1 unit	1CC	7.690
		3VL9400-4PD40		1	1 unit	1CC	9.298
Withdrawable version assembly kits							
Upgrade of the plug-in base assembly kit to							
	Withdrawable version including side panels and racking mechanism.	3-pole	3VL9400-4WF30 --1)	1	1 unit	1CC	4.822
		3-pole with RCD	3VL9400-4WF40	1	1 unit	1CC	4.880
		4-pole	3VL9400-4WG40	1	1 unit	1CC	6.523
		4-pole with RCD					
Withdrawable versions							
Same as plug-in base assembly kit, with additional side panels and racking mechanism							
Rear terminals³⁾							
		3-pole	3VL9400-4WA30 --1)	1	1 unit	1CC	12.650
		3-pole with RCD module	3VL9400-4WA40	1	1 unit	1CC	14.582
		4-pole	3VL9400-4WB40	1	1 unit	1CC	28.300
		4-pole with RCD module					
Front-accessible connections							
		3-pole	3VL9400-4WC30 --1)	1	1 unit	1CC	12.240
		3-pole with RCD module	3VL9400-4WC40	1	1 unit	1CC	14.240
		4-pole	3VL9400-4WD40	1	1 unit	1CC	18.219
		4-pole with RCD module					
Blade contacts							
As replacement for converting fixed-mounted circuit breakers into plug-in/withdrawable circuit breakers, including trip pin							
	1 set = 6 units	3-pole	3VL9400-4PS30	1	1 unit	1CC	1.292
	1 set = 8 units	4-pole	3VL9400-4PS40	1	1 unit	1CC	1.623
Trip pins and springs							
As replacement for plug-in/withdrawable circuit breaker							
			3VL9400-4PF00	1	1 unit	1CC	0.012
Auxiliary circuit plug connections for plug-in bases							
Accessory connections for plug-in circuit breakers (factory-wired connectors) and for plug-in bases or withdrawable version (coupling with screw terminal)							
	8 terminals		2)				
			3VL9400-4PJ00	1	1 unit	1CC	0.215
Position signaling switches							
(Connected/disconnected position)							
For plug-in/withdrawable base, 1 changeover contact, max. 2 signaling switches possible							
			3VL9000-4WL00	1	1 unit	1CC	0.037



3VL9.00-4PA30



3VL9.00-4WA30



3VL9000-4WL00

1) For 3-pole applications please use 4-pole withdrawable version with 4-pole RCD module and 4-pole circuit breaker.

2) It is recommended to use a maximum of 3 auxiliary circuit plug-in systems per circuit breaker (24 terminals).

3) With VL800 (3VL6) to VL1600 (3VL8) as vertical connection.

Molded Case Circuit Breakers

3VL Molded Case Circuit Breakers up to 1600 A, IEC

Accessories and spare parts

2



DT	For VL630 (3VL5)	Price per PU	PU (UNIT, SET, M)	PS*/P. unit	PG	Weight per PU approx. kg	DT	For VL800 (3VL6)	Price per PU	PU (UNIT, SET, M)	PS*/P. unit	PG	Weight per PU approx. kg
	Article No. www.siemens.com/product?Article No.							Article No. www.siemens.com/product?Article No.					
	3VL9500-4PA30		1	1 unit	1CC	9.186	--						
	3VL9500-4PA40		1	1 unit	1CC	12.424	--						
	--						--						
	--						--						
	3VL9500-4PC30		1	1 unit	1CC	8.025	--						
	3VL9500-4PC40		1	1 unit	1CC	10.720	--						
	--						--						
	3VL9500-4WF30		1	1 unit	1CC	5.200	--						
	3VL9500-4WF40		1	1 unit	1CC	4.740	--						
	--						--						
	3VL9500-4WA30		1	1 unit	1CC	15.360		3VL9600-4WA30		1	1 unit	1CC	43.880
	3VL9500-4WA40		1	1 unit	1CC	18.760		3VL9600-4WA40		1	1 unit	1CC	43.800
	--							--					
	3VL9500-4WC30		1	1 unit	1CC	14.180		3VL9600-4WC30		1	1 unit	1CC	44.460
	3VL9500-4WC40		1	1 unit	1CC	16.945		3VL9600-4WC40		1	1 unit	1CC	43.213
	--							--					
	3VL9500-4PS30		1	1 unit	1CC	1.603		3VL9600-4PS30		1	1 unit	1CC	3.744
	3VL9500-4PS40		1	1 unit	1CC	2.101		3VL9600-4PS40		1	1 unit	1CC	4.965
	3VL9500-4PF00		1	1 unit	1CC	0.014		3VL9600-4PF00		1	1 unit	1CC	0.014
	2)							2)					
	3VL9600-4PJ00		1	1 unit	1CC	0.216		3VL9600-4PJ00		1	1 unit	1CC	0.216
	3VL9000-4WL00		1	1 unit	1CC	0.037		3VL9000-4WL00		1	1 unit	1CC	0.037

Molded Case Circuit Breakers

3VL Molded Case Circuit Breakers up to 1600 A, IEC

Accessories and spare parts

2

Version	DT	For VL1250 (3VL7) Article No. www.siemens.com/ product?Article No.	Price per PU	PU (UNIT, SET, M)	PS*/ P. unit	PG	Weight per PU approx. kg
Plug-in versions/withdrawable versions							
 3VL9.00-4PA30	3- or 4-pole						
	Plug-in base assembly kits Base, blade contacts for circuit breakers, terminal covers for degree of protection IP20, fixing screws, trip pin						
	Rear terminals						
	3-pole	--					
3-pole with RCD module	--						
4-pole	--						
4-pole with RCD module	--						
90° angle connecting adapters							
For rear connection, 3-pole		--					
For rear connection, 4-pole		--					
Front-accessible connections							
3-pole		--					
3-pole with RCD module		--					
4-pole		--					
4-pole with RCD module		--					
 3VL9.00-4WA30	Withdrawable version assembly kits Upgrade of the plug-in base assembly kit to						
	Withdrawable version including side panels and racking mechanism.	3-pole 3-pole with RCD 4-pole 4-pole with RCD	-- -- -- --				
	Withdrawable versions Same as plug-in base assembly kit, with additional side panels and racking mechanism						
	Rear terminals¹⁾						
	3-pole	3VL9800-4WA30		1	1 unit	1CC	43.420
	3-pole with RCD module	--					
	4-pole	3VL9800-4WA40		1	1 unit	1CC	52.320
	4-pole with RCD module	--					
	Front-accessible connections						
	3-pole	3VL9800-4WC30		1	1 unit	1CC	45.000
3-pole with RCD module	--						
4-pole	3VL9800-4WC40		1	1 unit	1CC	53.000	
4-pole with RCD module	--						
Blade contacts As replacement for converting fixed-mounted circuit breakers into plug-in/withdrawable circuit breakers, including trip pin							
1 set = 6 units	3-pole	3VL9800-4PS30		1	1 unit	1CC	3.510
1 set = 8 units	4-pole	3VL9800-4PS40		1	1 unit	1CC	4.595
Trip pins and springs As replacement for plug-in/withdrawable circuit breaker		3VL9800-4PF00		1	1 unit	1CC	0.016
Auxiliary circuit plug connections for plug-in bases Accessory connections for plug-in circuit breakers (factory-wired connectors) and for plug-in bases or withdrawable version (coupling with screw terminal)		²⁾					
8 terminals		3VL9800-4PJ00		1	1 unit	1CC	0.217
Position signaling switches (Connected/disconnected position) For plug-in/withdrawable base, 1 changeover contact, max. 2 signaling switches possible		3VL9000-4WL00		1	1 unit	1CC	0.037

¹⁾ With VL800 (3VL6) to VL1600 (3VL8) as vertical connection.

²⁾ It is recommended to use a maximum of 3 auxiliary circuit plug-in systems per circuit breaker (24 terminals).

DT	For VL1600 (3VL8) Article No. www.siemens.com/ product?Article No.	Price per PU	PU (UNIT, SET, M)	PS*/ P. unit	PG	Weight per PU approx. kg
	--					
	--					
	--					
	--					
	--					
	--					
	--					
	3VL9800-4WA30		1	1 unit	1CC	43.420
	--					
	3VL9800-4WA40		1	1 unit	1CC	52.320
	--					
	3VL9800-4WC30		1	1 unit	1CC	45.000
	--					
	3VL9800-4WC40		1	1 unit	1CC	53.000
	--					
	3VL9800-4PS30		1	1 unit	1CC	3.510
	3VL9800-4PS40		1	1 unit	1CC	4.595
	3VL9800-4PF00		1	1 unit	1CC	0.016
	2)					
	3VL9800-4PJ00		1	1 unit	1CC	0.217
	3VL9000-4WL00		1	1 unit	1CC	0.037

Molded Case Circuit Breakers

3VL Molded Case Circuit Breakers up to 1600 A, IEC

Accessories and spare parts

2

Circuit breakers for line protection, only for TM, starters, disconnectors	Rated current I_n	Residual currents I_{Δ} adjustable	Delay time t_d adjustable	Rated operational voltage U_e	DT	Article No. www.siemens.com/product?Article.No.	Price per PU	PU (UNIT, SET, M)	PS*/P. unit	PG	Weight per PU approx.
	A	A	s	V AC							kg

RCD modules



Molded case circuit breakers VL160X to VL400 with RCD module mounted below the circuit breaker

3-pole

VL160X (3VL1)		0.03	Instantaneous								
Bottom mounting ¹⁾²⁾	160	0.10	0.06	127 ... 480		3VL9112-5GA30		1	1 unit	1CC	1.500
VL160 (3VL2)	160	0.30	0.10	127 ... 480		3VL9216-5GC30		1	1 unit	1CC	1.438
		0.50	0.25	230 ... 690		3VL9216-5GD30		1	1 unit	1CC	1.427
VL250 (3VL3)	250	1.00	0.50	127 ... 480		3VL9325-5GE30		1	1 unit	1CC	1.478
		3.00	1.00	230 ... 690		3VL9325-5GF30		1	1 unit	1CC	1.487
VL400 (3VL4)	400			127 ... 480		--					
				230 ... 690		--					

4-pole

VL160X (3VL1)		0.03	Instantaneous								
Bottom mounting ¹⁾²⁾	160	0.10	0.06	127 ... 480		3VL9112-5GA40		1	1 unit	1CC	1.849
VL160 (3VL2)	160	0.30	0.10	127 ... 480		3VL9216-5GC40		1	1 unit	1CC	1.743
		0.50	0.25	230 ... 690		3VL9216-5GD40		1	1 unit	1CC	1.700
VL250 (3VL3)	250	1.00	0.50	127 ... 480		3VL9325-5GE40		1	1 unit	1CC	1.806
		3.00	1.00	230 ... 690		3VL9325-5GF40		1	1 unit	1CC	1.810
VL400 (3VL4)	400			127 ... 480		3VL9440-5GG40		1	1 unit	1CC	3.327
				230 ... 690		3VL9440-5GH40		1	1 unit	1CC	3.325

Circuit breakers for line protection, only for TM, starters, disconnectors	Rated current I_n	Residual currents I_{Δ} adjustable	Delay time t_d adjustable	Rated operational voltage U_e	3-pole circuit breakers		4-pole circuit breakers	
	A	A	s	V AC	Article No. with "-Z"	Add. price	Article No. with "-Z"	Add. price
					3VL.....D.....-Z		3VL.....E.....-Z	
					and additional order code		and additional order code	
					<input type="checkbox"/> <input type="checkbox"/> <input type="checkbox"/> Code for further versions		<input type="checkbox"/> <input type="checkbox"/> <input type="checkbox"/> Code for further versions	
					-Z		-Z	

Circuit breakers with RCD module



3- and 4-pole

VL160X (3VL1)		0.03	Instantaneous							
(Bottom mounting)	160	0.10	0.06	127 ... 480	A 0 1	1) ²⁾	✓	A 0 1	1) ²⁾	✓
		0.30	0.10							
		0.50	0.25							
VL160 (3VL2)	160	1.00	0.50	127 ... 480	A 0 1		✓	A 0 1		✓
		3.00	1.00	230 ... 690	A 0 2		✓	A 0 2		✓
VL250 (3VL3)	250			127 ... 480	A 0 1		✓	A 0 1		✓
				230 ... 690	A 0 2		✓	A 0 2		✓
VL400 (3VL4)	400			127 ... 480	--			A 0 1		✓
				230 ... 690	--			A 0 2		✓

Residual current devices (MRCD)













Modular residual current devices (MRCD) monitor residual currents in electrical systems and trip the molded case circuit breaker via an auxiliary release after an adjustable advance warning if the residual current exceeds a defined value.

See chapter "Monitoring Devices".

✓ Additional price

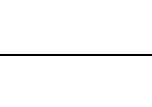
¹⁾ Only the right-hand accessory compartment and the N conductor (4-pole) accessory compartment can be used for the installation of accessories, see Technical Information at www.siemens.com/lowvoltage/product-support.

²⁾ VL160X (3VL1) + RCD module cannot be combined with motorized operating mechanism, front operating mechanism, door-coupling rotary operating mechanism, locking device for toggle levers, screw terminal connections (3VL17.....6-....) and Bowden wire interlocking.

Version	DT	For VL160X (3VL1) Article No. www.siemens.com/ product?Article No.	Price per PU	PU (UNIT, SET, M)	PS*/P. unit	PG	Weight per PU approx. kg
Connection parts for fixed-mounted circuit breakers¹⁾							
3- or 4-pole							
Front connecting bars²⁾							
Phase barriers included.							
Standard							
	1 set = 3 units	3-pole	3VL9216-4EC30		1	1 unit	1CC 0.212
	1 set = 4 units	4-pole	3VL9216-4EC40		1	1 unit	1CC 0.287
For increased pole spacing							
	1 set = 3 units	3-pole	3VL9216-4ED30		1	1 unit	1CC 0.224
	1 set = 4 units	4-pole	3VL9216-4ED40		1	1 unit	1CC 0.348
Rear terminals							
Short connection (1 unit)							
			3VL9100-4RA00		1	1 unit	1CC 0.163
Long connection (1 unit)							
			3VL9100-4RB00		1	1 unit	1CC 0.260
Terminal kit (2 short + 1 long)							
3-pole							
			3VL9100-4RC30		1	1 unit	1CC 0.556
Terminal kit (2 short + 2 long)							
4-pole							
			3VL9100-4RF40		1	1 unit	1CC 0.805
Short flat connection (1 unit)							
			3VL9100-4RK00		1	1 unit	1CC 0.104
Long flat connection (1 unit)							
			3VL9100-4RL00		1	1 unit	1CC 0.222
Flat connector kit (2 short + 1 long)							
3-pole							
			3VL9100-4RM30		1	1 unit	1CC 0.408
Flat connector kit (2 short + 2 long)							
4-pole							
			3VL9100-4RN40		1	1 unit	1CC 0.652
Box terminals							
For connection for flexible flat copper busbar or cable, see Technical Information at www.siemens.com/lowvoltage/product-support .							
	1 set = 3 units		3VL9100-4TC30		1	1 unit	1CC 0.103
	1 set = 4 units		3VL9100-4TC40		1	1 unit	1CC 0.132
Circular conductor terminals							
Only for cables (Al or Cu), aluminum terminal (tinned)							
	1 set = 3 units		3VL9100-4TD30		1	1 unit	1CC 0.100
	1 set = 4 units		3VL9100-4TD40		1	1 unit	1CC 0.121
Circular conductor terminal with terminal covers for cable (Al or Cu)							
	1 set = 3 units		3VL9115-4TD30		1	1 unit	1CC 0.337
	1 set = 4 units		3VL9115-4TD40		1	1 unit	1CC 0.429
Auxiliary conductor terminals							
For box terminals/circular conductor terminals							
	1 set = 10 units		3VL9200-3TN00		1	1 unit	1CC 0.125
Terminals with screw connection - metric thread							
With insulator (for rear) for use with busbars and cable lugs, see Technical Information at www.siemens.com/lowvoltage/product-support .							
	1 set = 3 units		3VL9116-4TA30		1	1 unit	1CC 0.067
	1 set = 4 units		3VL9116-4TA40		1	1 unit	1CC 0.084
Connection covers (terminal covers) for circuit breakers							
Degree of protection IP30 for main connections							
	1 set = 2 units						
NSE0_00730							
3VL9.00-3CB.0							
Extended		3-pole	3VL9300-8CA30		1	1 unit	1CC 0.292
Standard		3-pole	3VL9300-8CB30		1	1 unit	1CC 0.064
Extended		4-pole	3VL9300-8CA40		1	1 unit	1CC 0.364
Standard		4-pole	3VL9300-8CB40		1	1 unit	1CC 0.082
Phase barriers for circuit breakers, fixed-mounted, plug-in or withdrawable versions							
	1 set = 2 units		3VL9300-8CE00		1	1 unit	1CC 0.032
NSE0_00731							
3VL9.00-8CE00							

¹⁾ For an overview of connectable connection parts, see page 2/123.











²⁾ Screw terminal connections are required for VL160X and VL160 molded case circuit breakers (3VL1 and 3VL2), see Technical Information at www.siemens.com/lowvoltage/product-support.

Molded Case Circuit Breakers

3VL Molded Case Circuit Breakers up to 1600 A, IEC

Accessories and spare parts

2

Version	DT	For VL160 (3VL2)	Price per PU	PU (UNIT, SET, M)	PS*/P. unit	PG	Weight per PU approx. kg	
Connection parts for fixed-mounted circuit breakers¹⁾								
3- or 4-pole								
Front connecting bars²⁾								
Phase barriers included.								
Standard								
	1 set = 3 units	3-pole	3VL9216-4EC30	1	1 unit	1CC	0.212	
	1 set = 4 units	4-pole	3VL9216-4EC40	1	1 unit	1CC	0.287	
For increased pole spacing								
	1 set = 3 units	3-pole	3VL9216-4ED30	1	1 unit	1CC	0.224	
	1 set = 4 units	4-pole	3VL9216-4ED40	1	1 unit	1CC	0.348	
Rear terminals								
Short connection (1 unit)								
Long connection (1 unit)								
			3VL9200-4RA00	1	1 unit	1CC	0.161	
			3VL9200-4RB00	1	1 unit	1CC	0.264	
		Terminal kit (2 short + 1 long) 3-pole	3VL9200-4RC30	1	1 unit	1CC	0.565	
		Terminal kit (2 short + 2 long) 4-pole	3VL9200-4RF40	1	1 unit	1CC	0.817	
Short flat connection (1 unit)								
Long flat connection (1 unit)								
			3VL9200-4RK00	1	1 unit	1CC	0.131	
			3VL9200-4RL00	1	1 unit	1CC	0.227	
		Flat connector kit (2 short + 1 long) 3-pole	3VL9200-4RM30	1	1 unit	1CC	0.455	
		Flat connector kit (2 short + 2 long) 4-pole	3VL9200-4RN40	1	1 unit	1CC	0.656	
Box terminal								
Connection for flexible flat copper busbar or cable, see Technical Information at www.siemens.com/lowvoltage/product-support .								
	1 set = 3 units		3VL9200-4TC30	1	1 unit	1CC	0.122	
	1 set = 4 units		3VL9200-4TC40	1	1 unit	1CC	0.155	
Circular conductor terminals								
Only for cables (Al or Cu), aluminum terminal (tinned)								
	1 set = 3 units		3VL9200-4TD30	1	1 unit	1CC	0.138	
	1 set = 4 units		3VL9200-4TD40	1	1 unit	1CC	0.159	
Circular conductor terminal with terminal covers for cable (Al or Cu)								
		1 set = 3 units	3VL9215-4TD30	1	1 unit	1CC	0.360	
		1 set = 4 units	3VL9215-4TD40	1	1 unit	1CC	0.455	
Multiple feed-in terminal without terminal covers								
	3 units (2 x 50 ... 120)		--					
	4 units (2 x 50 ... 120)		--					
Multiple feed-in terminal with terminal covers								
		3 units (2 x 70 ... 300)	--					
		4 units (2 x 70 ... 300)	--					
Auxiliary conductor terminals								
For box terminals/circular conductor terminals/multiple feed-in terminals								
		1 set = 10 units	3VL9200-3TN00	1	1 unit	1CC	0.125	
Terminals with screw connection - metric thread								
With insulator (for rear) for use with busbars and cable lugs, see Technical Information at www.siemens.com/lowvoltage/product-support .								
	1 set = 3 units		3VL9216-4TA30	1	1 unit	1CC	0.080	
	1 set = 4 units		3VL9216-4TA40	1	1 unit	1CC	0.108	
Connection covers (terminal covers) for circuit breakers								
Degree of protection IP30 for main connections								
	1 set = 2 units							
		Extended	3-pole	3VL9300-8CA30	1	1 unit	1CC	0.292
		Standard	3-pole	3VL9300-8CB30	1	1 unit	1CC	0.064
		Extended	4-pole	3VL9300-8CA40	1	1 unit	1CC	0.364
		Standard	4-pole	3VL9300-8CB40	1	1 unit	1CC	0.082
Phase barriers for circuit breakers, fixed-mounted, plug-in or withdrawable versions								
	1 set = 2 units		3VL9300-8CE00	1	1 unit	1CC	0.032	

¹⁾ For an overview of connectable connection parts, see page 2/123.

²⁾ Screw terminal connections are required for VL160X and VL160 molded case circuit breakers (3VL1 and 3VL2), see Technical Information at www.siemens.com/lowvoltage/product-support.

Molded Case Circuit Breakers

3VL Molded Case Circuit Breakers up to 1600 A, IEC

Accessories and spare parts

2









DT	For VL250 (3VL3)	Price per PU	PU (UNIT, SET, M)	PS*/ P. unit	PG	Weight per PU approx. kg	DT	For VL400 (3VL4)	Price per PU	PU (UNIT, SET, M)	PS*/ P. unit	PG	Weight per PU approx. kg
	Article No. www.siemens.com/product?Article No.							Article No. www.siemens.com/product?Article No.					
	3VL9300-4EC30		1	1 unit	1CC	0.269		3VL9400-4EC30		1	1 unit	1CC	0.918
	3VL9300-4EC40		1	1 unit	1CC	0.346		3VL9400-4EC40		1	1 unit	1CC	1.256
	3VL9300-4ED30		1	1 unit	1CC	0.256		3VL9400-4ED30		1	1 unit	1CC	0.896
	3VL9300-4ED40		1	1 unit	1CC	0.425		3VL9400-4ED40		1	1 unit	1CC	1.476
	3VL9300-4RA00		1	1 unit	1CC	0.161		3VL9400-4RA00		1	1 unit	1CC	0.268
	3VL9300-4RB00		1	1 unit	1CC	0.265		3VL9400-4RB00		1	1 unit	1CC	0.433
	3VL9300-4RC30		1	1 unit	1CC	0.562		3VL9400-4RC30		1	1 unit	1CC	0.930
	3VL9300-4RF40		1	1 unit	1CC	0.850		3VL9400-4RF40		1	1 unit	1CC	1.337
	3VL9300-4RK00		1	1 unit	1CC	0.126		3VL9400-4RK00		1	1 unit	1CC	0.380
	3VL9300-4RL00		1	1 unit	1CC	0.228		3VL9400-4RL00		1	1 unit	1CC	0.542
	3VL9300-4RM30		1	1 unit	1CC	0.447		3VL9400-4RM30		1	1 unit	1CC	1.305
	3VL9300-4RN40		1	1 unit	1CC	0.660		3VL9400-4RN40		1	1 unit	1CC	1.783
	3VL9300-4TC30		1	1 unit	1CC	0.206		3VL9400-4TC30		1	1 unit	1CC	0.488
	3VL9300-4TC40		1	1 unit	1CC	0.275		3VL9400-4TC40		1	1 unit	1CC	0.617
	3VL9300-4TD30		1	1 unit	1CC	0.183		3VL9400-4TD30		1	1 unit	1CC	0.293
	3VL9300-4TD40		1	1 unit	1CC	0.235		3VL9400-4TD40		1	1 unit	1CC	0.391
	3VL9324-4TD30		1	1 unit	1CC	0.487		--					
	3VL9324-4TD40		1	1 unit	1CC	0.676		--					
	--							3VL9400-4TF30		1	1 unit	1CC	0.434
	--							3VL9400-4TF40		1	1 unit	1CC	0.575
	--							3VL9460-4TF30		1	1 unit	1CC	0.892
	--							3VL9460-4TF40		1	1 unit	1CC	1.141
	3VL9300-3TN00		1	1 unit	1CC	0.133		3VL9400-3TN00		1	1 unit	1CC	0.140
	3VL9300-4TA30		1	1 unit	1CC	0.114		3VL9400-4TA30		1	1 unit	1CC	0.125
	3VL9300-4TA40		1	1 unit	1CC	0.144		3VL9400-4TA40		1	1 unit	1CC	0.161
	3VL9300-8CA30		1	1 unit	1CC	0.292		3VL9400-8CA30		1	1 unit	1CC	0.625
	3VL9300-8CB30		1	1 unit	1CC	0.064		3VL9400-8CB30		1	1 unit	1CC	0.124
	3VL9300-8CA40		1	1 unit	1CC	0.364		3VL9400-8CA40		1	1 unit	1CC	0.705
	3VL9300-8CB40		1	1 unit	1CC	0.082		3VL9400-8CB40		1	1 unit	1CC	0.177
	3VL9300-8CE00		1	1 unit	1CC	0.032		3VL9600-8CE00		1	1 unit	1CC	0.057

Molded Case Circuit Breakers

3VL Molded Case Circuit Breakers up to 1600 A, IEC

Accessories and spare parts

2

Version	DT	For VL630 (3VL5) Article No. www.siemens.com/ product?Article.No.	Price per PU	PU (UNIT, SET, M)	PS*/ P. unit	PG	Weight per PU approx. kg
Connection parts for fixed-mounted circuit breakers¹⁾							
3- or 4-pole							
Front connecting bars Phase barriers included.							
Standard							
	1 set = 3 units	3-pole	3VL9500-4EC30	1	1 unit	1CC	1.160
	1 set = 4 units	4-pole	3VL9500-4EC40	1	1 unit	1CC	1.522
For increased pole spacing							
	1 set = 3 units	3-pole	3VL9500-4ED30	1	1 unit	1CC	1.172
	1 set = 4 units	4-pole	3VL9500-4ED40	1	1 unit	1CC	1.545
Flat connecting bar (1 unit) Flat connecting bars							
	Set = 3 units, 3-pole		3VL9500-4RG00	1	1 unit	1CC	0.448
	Set = 4 units, 4-pole		3VL9500-4RH30	1	1 unit	1CC	1.174
			3VL9500-4RH40	1	1 unit	1CC	1.519
Multiple feed-in terminals Only for cables (Al or Cu) Aluminum terminal (tinned)							
	1 set = 3 units		3VL9500-4TG30	1	1 unit	1CC	0.558
	1 set = 4 units		3VL9500-4TG40	1	1 unit	1CC	0.697
Auxiliary conductor terminals For multiple feed-in terminals 1 set = 10 units							
			3VL9400-3TN00	1	1 unit	1CC	0.140
Terminal plates²⁾ Connection for flexible flat copper busbar with auxiliary conductor connection 0.5 – 4 mm ² (extended terminal covers or phase barriers required)							
	1 set = 3 units		3VL9500-4TT30	1	1 unit	1CC	1.510
	1 set = 4 units		3VL9500-4TT40	1	1 unit	1CC	1.874
Terminals with screw connection – metric thread With insulator (for rear) for use with busbars and cable lugs, see Technical Information at www.siemens.com/lowvoltage/product-support .							
	1 set = 3 units		3VL9500-4TA30	1	1 unit	1CC	0.134
	1 set = 4 units		3VL9500-4TA40	1	1 unit	1CC	0.163
Connection covers (terminal covers) for circuit breakers Degree of protection IP30 for main connections							
	1 set = 2 units						
	Extended	3-pole	3VL9600-8CA30	1	1 unit	1CC	0.930
	Standard	3-pole	3VL9600-8CB30	1	1 unit	1CC	0.219
	Extended	4-pole	3VL9600-8CA40	1	1 unit	1CC	1.062
	Standard	4-pole	3VL9600-8CB40	1	1 unit	1CC	0.287
Phase barriers for circuit breakers, fixed-mounted, plug-in or withdrawable versions³⁾							
	1 set = 2 units		3VL9600-8CE00	1	1 unit	1CC	0.057

¹⁾ For an overview of connectable connection parts, see page 2/123.

²⁾ Front connecting bars included in scope of supply;
not for 690 V AC/600 V DC.

³⁾ Plug-in versions: Not for VL1250 (3VL7),
withdrawable version: Not for VL800 (3VL6) and VL1250 (3VL7).

Molded Case Circuit Breakers

3VL Molded Case Circuit Breakers up to 1600 A, IEC

Accessories and spare parts

2







DT	For VL800 (3VL6)	Price per PU	PU (UNIT, SET, M)	PS*/P. unit	PG	Weight per PU approx. kg	DT	For VL1250 (3VL7)	Price per PU	PU (UNIT, SET, M)	PS*/P. unit	PG	Weight per PU approx. kg
	Article No. www.siemens.com/product?Article.No.							Article No. www.siemens.com/product?Article.No.					
	3VL9600-4EC30 3VL9600-4EC40		1 1	1 unit 1 unit	1CC 1CC	1.725 2.301		3VL9800-4EC30 3VL9800-4EC40		1 1	1 unit 1 unit	1CC 1CC	3.562 4.385
	3VL9600-4ED30 3VL9600-4ED40		1 1	1 unit 1 unit	1CC 1CC	1.733 2.287		-- --					
	3VL9600-4RG00 3VL9600-4RH30 3VL9600-4RH40		1 1 1	1 unit 1 unit 1 unit	1CC 1CC 1CC	1.629 4.770 6.510		3VL9700-4RG00 3VL9700-4RH30 3VL9700-4RH40		1 1 1	1 unit 1 unit 1 unit	1CC 1CC 1CC	1.638 4.960 6.523
	3VL9600-4TG30 3VL9600-4TG40		1 1	1 unit 1 unit	1CC 1CC	1.024 1.286		3VL9700-4TG30 3VL9700-4TG40		1 1	1 unit 1 unit	1CC 1CC	2.235 2.950
	3VL9400-3TN00		1	1 unit	1CC	0.140		3VL9400-3TN00		1	1 unit	1CC	0.140
	-- --							-- --					
	3VL9600-4TA30 3VL9600-4TA40		1 1	1 unit 1 unit	1CC 1CC	0.236 0.311		3VL9800-4TA30 3VL9800-4TA40		1 1	1 unit 1 unit	1CC 1CC	0.273 0.506
	3VL9600-8CA30 3VL9600-8CB30 3VL9600-8CA40 3VL9600-8CB40		1 1 1 1	1 unit 1 unit 1 unit 1 unit	1CC 1CC 1CC 1CC	0.930 0.219 1.062 0.287		3VL9800-8CA30 3VL9800-8CB30 3VL9800-8CA40 3VL9800-8CB40		1 1 1 1	1 unit 1 unit 1 unit 1 unit	1CC 1CC 1CC 1CC	1.240 0.412 1.500 0.536
	3VL9600-8CE00		1	1 unit	1CC	0.057		3VL9800-8CE00		1	1 unit	1CC	0.150

Molded Case Circuit Breakers

3VL Molded Case Circuit Breakers up to 1600 A, IEC

Accessories and spare parts

2

Version	DT	For VL1600 (3VL8) Article No. www.siemens.com/ product?Article No.	Price per PU	PU (UNIT, SET, M)	PS*/ P. unit	PG	Weight per PU approx. kg
Connection parts for fixed-mounted circuit breakers¹⁾							
3- or 4-pole							
Front connecting bars Phase barriers included.							
 3VL9216-4EC40	Standard ²⁾						
	1 set = 3 units	3-pole	3VL9800-4EC30	1	1 unit	1CC	3.562
	1 set = 4 units	4-pole	3VL9800-4EC40	1	1 unit	1CC	4.385
 3VL9216-4ED40	For increased pole spacing						
	1 set = 3 units	3-pole	--				
	1 set = 4 units	4-pole	--				
Rear terminals							
 3VL9.00-4RG00	Flat connecting bar (1 unit)		3VL9800-4RG00	1	1 unit	1CC	1.597
	Flat connecting bars Set = 3 units, 3-pole		3VL9800-4RH30	1	1 unit	1CC	4.965
	Flat connecting bars Set = 4 units, 4-pole		3VL9800-4RH40	1	1 unit	1CC	6.105
Terminals with screw connection - metric thread							
 3VL9.00-4TA.0	With insulator (for rear) for use with busbars and cable lugs, see Technical Information at www.siemens.com/lowvoltage/product-support .						
	1 set = 3 units		3VL9800-4TA30	1	1 unit	1CC	0.273
	1 set = 4 units		3VL9800-4TA40	1	1 unit	1CC	0.506
Connection covers (terminal covers) for circuit breakers							
 NSE0_00730 3VL9.00-3CB.0	Degree of protection IP30 for main connections 1 set = 2 units						
	Extended	3-pole	3VL9800-8CA30	1	1 unit	1CC	1.240
	Standard	3-pole	3VL9800-8CB30	1	1 unit	1CC	0.412
	Extended	4-pole	3VL9800-8CA40	1	1 unit	1CC	1.500
	Standard	4-pole	3VL9800-8CB40	1	1 unit	1CC	0.536
Phase barriers for fixed-mounted circuit breakers							
 NSE0_00731 3VL9.00-8CE00	1 set = 2 units		3VL9800-8CE00	1	1 unit	1CC	0.150

¹⁾ For an overview of connectable connection parts, see page 2/123.

²⁾ In scope of supply of circuit breaker.

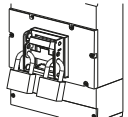
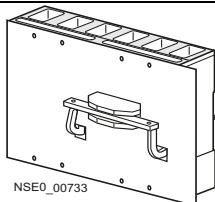
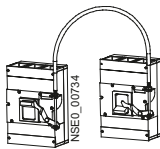
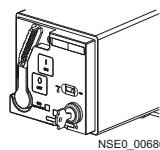
Version	DT	For VL160X (3VL1) Article No. www.siemens.com/ product?Article No.	Price per PU	PU (UNIT, SET, M)	PS*/ P. unit	PG	Weight per PU approx. kg
Interlocks							
3- or 4-pole							
 NSE0_00732 3VL9.00-3HL00		Locking devices for toggle levers For locking the circuit breaker in the "OFF" position. Up to 3 padlocks with Ø 5 – 8 mm can be used. Removable (padlocks not included)	3VL9300-3HL00		1	1 unit	1CC 0.069
 NSE0_00733 3VL9.00-8L.00		Rear interlocking modules For the mechanical interlocking of two adjacent circuit breakers. The circuit breakers must be of the same installation type and size. (Mounting plate not included in scope of supply)					
		Fixed-mounted circuit breakers	3VL9300-8LC00		1	1 unit	1CC 0.320
		Plug-in/withdrawable circuit breakers	3VL9300-8LD00		1	1 unit	1CC 0.383
 NSE0_00734 3VL9.00-8LA00		Interlocking modules for Bowden wire interlocking¹⁾ For the mechanical interlocking of two circuit breakers. Interlocking module for one circuit breaker	Combination with next size up possible (see Article No.) 3VL9300-8LA00		1	1 unit	1CC 0.248
		Bowden wires for Bowden wire interlocking ¹⁾					
		Wire length 0.5 m	3VL9000-8LH10		1	1 unit	1CC 0.303
		Wire length 1.0 m	3VL9000-8LH20		1	1 unit	1CC 0.371
		Wire length 1.5 m	3VL9000-8LH30		1	1 unit	1CC 0.646
 NSE0_00680 3VL9...-8HA00		Safety lock assembly kits Key can be removed with the circuit breaker in the "OFF" position For front-operated rotary operating mechanisms Lock types Ronis	3VL9715-8HA00		1	1 unit	1CC 0.267
		For motorized operating mechanism with stored energy mechanism Lock types Ronis	--				
		Filli Giussani	3VL9321-8HA00		1	1 unit	1CC 0.039
		Sets of fixing screws (metric thread) Including the screws, washers and nuts required to secure a 3- or 4-pole circuit breaker to a prepared surface Set with 4 screws	3VL9300-8SA40		1	1 unit	1CC 0.053
		Transparent covers for releases, sealable To prevent access by unqualified personnel and unauthorized changes to settings (seal not included) Electronic Trip Unit	--				
		Thermal-magnetic	3VL9300-8BM00		1	1 unit	1CC 0.017

¹⁾ Two interlocking modules and one Bowden wire are required. Cannot be used in conjunction with motorized operating mechanism and withdrawable version!

Molded Case Circuit Breakers

3VL Molded Case Circuit Breakers up to 1600 A, IEC

Accessories and spare parts

2

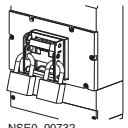
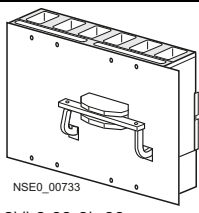
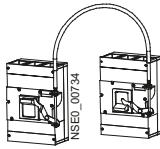
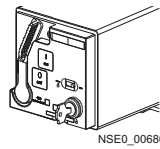
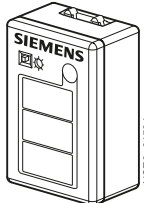
Version	DT	For VL160 (3VL2) Article No. www.siemens.com/ product?Article.No.	Price per PU	PU (UNIT, SET, M)	PS*/ P. unit	PG	Weight per PU approx. kg
Interlocks							
 NSE0_00732 3VL9.00-3HL00	3- or 4-pole Locking devices for toggle levers For locking the circuit breaker in the "OFF" position. Up to 3 padlocks with Ø 5 – 8 mm can be used. Removable (padlocks not included)	3VL9300-3HL00		1	1 unit	1CC	0.069
 NSE0_00733 3VL9.00-8L.00	Rear interlocking modules For the mechanical interlocking of two adjacent circuit breakers. The circuit breakers must be of the same installation type and size. (Mounting plate not included in scope of supply) Fixed-mounted circuit breakers Plug-in/withdrawable circuit breakers	3VL9300-8LC00 3VL9300-8LD00		1 1	1 unit 1 unit	1CC 1CC	0.320 0.383
 NSE0_00734 3VL9.00-8LA00	Interlocking modules for Bowden wire interlocking¹⁾ For the mechanical interlocking of two circuit breakers. Interlocking module for one circuit breaker	3VL9300-8LA00		1	1 unit	1CC	0.248
	Bowden wires for Bowden wire interlocking ¹⁾ Wire length 0.5 m Wire length 1.0 m Wire length 1.5 m	3VL9000-8LH10 3VL9000-8LH20 3VL9000-8LH30		1 1 1	1 unit 1 unit 1 unit	1CC 1CC 1CC	0.303 0.371 0.646
 NSE0_00680 3VL9...-8HA00	Safety lock assembly kits Key can be removed with the circuit breaker in the "OFF" position For front-operated rotary operating mechanisms Lock types Ronis For motorized operating mechanism with stored energy mechanism Lock types Ronis Filli Giussani	3VL9715-8HA00 -- 3VL9321-8HA00		1 1	1 unit 1 unit	1CC 1CC	0.267 0.039
	Sets of fixing screws (metric thread) Including the screws, washers and nuts required to secure a 3- or 4-pole circuit breaker to a prepared surface Set with 4 screws	3VL9300-8SA40		1	1 unit	1CC	0.053
 NSE0_01631a 3VL9000-8AP01	Transparent covers for releases, sealable To prevent access by unqualified personnel and unauthorized changes to settings (seal not included) Electronic Trip Unit Thermal-magnetic	3VL9700-8BL00 3VL9300-8BM00		1 1	1 unit 1 unit	1CC 1CC	0.009 0.017
	Battery power supply for activating/ parameterizing the LCD ETUs, with test function for all IEC and UL ETUs (two 9 V blocks are required in addition)	3VL9000-8AP01		1	1 unit	1CC	0.208

¹⁾ Two interlocking modules and one Bowden wire are required. Cannot be used in conjunction with motorized operating mechanism and withdrawable version!

Molded Case Circuit Breakers

3VL Molded Case Circuit Breakers up to 1600 A, IEC

Accessories and spare parts

2

DT	For VL250 (3VL3)	Price per PU	PU (UNIT, SET, M)	PS*/P. unit	PG	Weight per PU approx. kg	DT	For VL400 (3VL4)	Price per PU	PU (UNIT, SET, M)	PS*/P. unit	PG	Weight per PU approx. kg
	Article No. www.siemens.com/product?Article No.							Article No. www.siemens.com/product?Article No.					
	3VL9300-3HL00		1	1 unit	1CC	0.069		3VL9400-3HL00		1	1 unit	1CC	0.144
	3VL9300-8LC00		1	1 unit	1CC	0.320		3VL9400-8LC00		1	1 unit	1CC	1.170
	3VL9300-8LD00		1	1 unit	1CC	0.383		3VL9400-8LD00		1	1 unit	1CC	1.280
	3VL9300-8LA00		1	1 unit	1CC	0.248		3VL9400-8LA00		1	1 unit	1CC	0.210
	3VL9000-8LH10		1	1 unit	1CC	0.303		--					
	3VL9000-8LH20		1	1 unit	1CC	0.371		3VL9000-8LH20		1	1 unit	1CC	0.371
	3VL9000-8LH30		1	1 unit	1CC	0.646		3VL9000-8LH30		1	1 unit	1CC	0.646
	3VL9715-8HA00		1	1 unit	1CC	0.267		3VL9715-8HA00		1	1 unit	1CC	0.267
	--							3VL9715-8HA00		1	1 unit	1CC	0.267
	3VL9321-8HA00		1	1 unit	1CC	0.039		--					
	3VL9300-8SA40		1	1 unit	1CC	0.053		3VL9500-8SA40		1	1 unit	1CC	0.109
	3VL9700-8BL00		1	1 unit	1CC	0.009		3VL9700-8BL00		1	1 unit	1CC	0.009
	3VL9300-8BM00		1	1 unit	1CC	0.017		3VL9400-8BM00		1	1 unit	1CC	0.028
	3VL9000-8AP01		1	1 unit	1CC	0.208		3VL9000-8AP01		1	1 unit	1CC	0.208

Molded Case Circuit Breakers

3VL Molded Case Circuit Breakers up to 1600 A, IEC

Accessories and spare parts

2

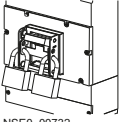
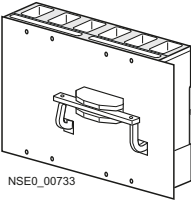
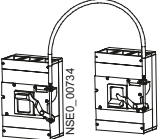
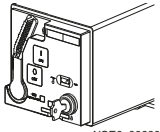
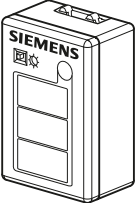
Version	DT	For VL630 (3VL5) Article No. www.siemens.com/ product?Article No.	Price per PU	PU (UNIT, SET, M)	PS*/ P. unit	PG	Weight per PU approx. kg
Interlocks							
3- or 4-pole							
Locking devices for toggle levers							
For locking the circuit breaker in the "OFF" position. Up to 3 padlocks with Ø 5–8 mm can be used. Removable (padlocks not included)							
 NSE0_00732 3VL9.00-3HL00		3VL9600-3HL00		1	1 unit	1CC	0.162
Rear interlocking modules							
For the mechanical interlocking of two adjacent circuit breakers. The circuit breakers must be of the same installation type and size. (Mounting plate not included in scope of supply)							
Fixed-mounted circuit breakers							
Plug-in/withdrawable circuit breakers							
 NSE0_00733 3VL9.00-8L.00		3VL9600-8LC00 3VL9600-8LD00		1 1	1 unit 1 unit	1CC 1CC	4.356 5.413
Interlocking modules for Bowden wire interlocking¹⁾							
For the mechanical interlocking of two circuit breakers. Interlocking module for one circuit breaker							
Combinations with next size up/down possible (see Article No.)							
 NSE0_00734 3VL9.00-8LA00		3VL9600-8LA00		1	1 unit	1CC	0.275
Bowden wires for Bowden wire interlocking ¹⁾							
Wire length 0.5 m							
Wire length 1.0 m							
Wire length 1.5 m							
		--		1	1 unit	1CC	0.371
		3VL9000-8LH20 3VL9000-8LH30		1	1 unit	1CC	0.646
Safety lock assembly kits							
Key can be removed with the circuit breaker in the "OFF" position							
For front-operated rotary operating mechanisms							
Lock types							
Ronis							
For motorized operating mechanism with stored energy mechanism							
Lock types							
Ronis							
Filli Giussani							
 NSE0_00680 3VL9...-8HA00		3VL9715-8HA00 3VL9715-8HA00 --		1 1	1 unit 1 unit	1CC 1CC	0.267 0.267
Sets of fixing screws (metric thread)							
Including the screws, washers and nuts required to secure a 3- or 4-pole circuit breaker to a prepared surface							
Set with 4 screws							
		3VL9500-8SA40		1	1 unit	1CC	0.109
Transparent covers for releases, sealable							
To prevent access by unqualified personnel and unauthorized changes to settings (seal not included)							
Electronic Trip Units							
		3VL9700-8BL00 3VL9600-8BM00		1 1	1 unit 1 unit	1CC 1CC	0.009 0.031
Battery power supply for activating/parameterizing the LCD ETUs, with test function for all IEC and UL ETUs							
(two 9 V blocks are required in addition)							
 NSE0_01631a 3VL9000-8AP01		3VL9000-8AP01		1	1 unit	1CC	0.208

¹⁾ Two interlocking modules and one Bowden wire are required. Cannot be used in conjunction with motorized operating mechanism and withdrawable version!

Molded Case Circuit Breakers

3VL Molded Case Circuit Breakers up to 1600 A, IEC

Accessories and spare parts

2

DT	For VL800 (3VL6)	Price per PU	PU (UNIT, SET, M)	PS*/P. unit	PG	Weight per PU approx. kg	DT	For VL1250 (3VL7)	Price per PU	PU (UNIT, SET, M)	PS*/P. unit	PG	Weight per PU approx. kg
	Article No. www.siemens.com/product?Article No.							Article No. www.siemens.com/product?Article No.					
	3VL9600-3HL00		1	1 unit	1CC	0.162		3VL9800-3HL00		1	1 unit	1CC	0.244
	3VL9600-8LC00		1	1 unit	1CC	4.356		3VL9800-8LC00		1	1 unit	1CC	2.738
	3VL9600-8LD00		1	1 unit	1CC	5.413		3VL9800-8LD00		1	1 unit	1CC	3.402
	3VL9600-8LA00		1	1 unit	1CC	0.275		3VL9800-8LA00		1	1 unit	1CC	0.305
	--							--					
	3VL9000-8LH20		1	1 unit	1CC	0.371		--					
	3VL9000-8LH30		1	1 unit	1CC	0.646		3VL9000-8LH30		1	1 unit	1CC	0.646
	3VL9715-8HA00		1	1 unit	1CC	0.267		3VL9715-8HA00		1	1 unit	1CC	0.267
	3VL9715-8HA00		1	1 unit	1CC	0.267		3VL9715-8HA00		1	1 unit	1CC	0.267
	--							--					
	3VL9600-8SA40		1	1 unit	1CC	0.118		3VL9800-8SA40		1	1 unit	1CC	0.116
	3VL9700-8BL00		1	1 unit	1CC	0.009		3VL9700-8BL00		1	1 unit	1CC	0.009
	--							--					
	3VL9000-8AP01		1	1 unit	1CC	0.208		3VL9000-8AP01		1	1 unit	1CC	0.208

Molded Case Circuit Breakers

3VL Molded Case Circuit Breakers up to 1600 A, IEC

Accessories and spare parts

2

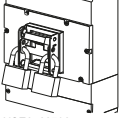
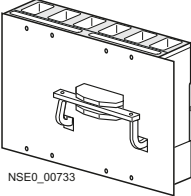
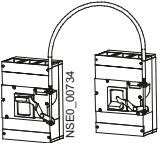
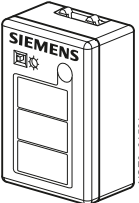
Version	DT	For VL1600 (3VL8) Article No. www.siemens.com/ product?Article.No.	Price per PU	PU (UNIT, SET, M)	PS*/ P. unit	PG	Weight per PU approx. kg
Interlocks							
3- or 4-pole							
Locking devices for toggle levers							
For locking the circuit breaker in the "OFF" position. Up to 3 padlocks with Ø 5 – 8 mm can be used. Removable (padlocks not included)							
 NSE0_00732 3VL9.00-3HL00		3VL9800-3HL00		1	1 unit	1CC	0.244
Rear interlocking modules							
For the mechanical interlocking of two adjacent circuit breakers. The circuit breakers must be of the same installation type and size. Circuit breakers, fixed-mounted ¹⁾ Plug-in/withdrawable circuit breakers							
 NSE0_00733 3VL9.00-8L.00		3VL9800-8LC00 3VL9800-8LD00		1 1	1 unit 1 unit	1CC 1CC	2.738 3.402
Interlocking modules for Bowden wire interlocking²⁾							
For the mechanical interlocking of two circuit breakers. Interlocking module for one circuit breaker							
 NSE0_00734 3VL9.00-8LA00		3VL9800-8LA00		1	1 unit	1CC	0.305
Bowden wires for Bowden wire interlocking ²⁾							
Wire length 0.5 m							
Wire length 1.0 m							
Wire length 1.5 m							
		3VL9000-8LH30		1	1 unit	1CC	0.646
Safety lock assembly kits							
Key can be removed with the circuit breaker in the "OFF" position <u>For front-operated rotary operating mechanisms</u> Lock types							
Ronis							
3VL9715-8HA00							
<u>For motorized operating mechanisms</u> Lock types							
Ronis							
3VL9715-8HA00							
Filli Giussani							
Sets of fixing screws (metric thread)							
Including the screws, washers and nuts required to secure a 3- or 4-pole circuit breaker to a prepared surface Set with 4 screws							
3VL9800-8SA40							
Transparent covers for releases, sealable							
To prevent access by unqualified personnel and unauthorized changes to settings (seal not included) Electronic Trip Unit							
3VL9700-8BL00							
Thermal-magnetic							
Battery power supply for activating/parameterizing the LCD ETUs, with test function for all IEC and UL ETUs (two 9 V blocks are required in addition)							
3VL9000-8AP01							
 NSE0_01531a 3VL9000-8AP01				1	1 unit	1CC	0.208

1) Mounting plate not included in scope of supply.

2) Two interlocking modules and one Bowden wire are required.
Cannot be used in conjunction with motorized operating mechanism and withdrawable version!

Transfer control devices



3KC ATC5300 and **NEW** ATC3100 transfer control devices. For combination with two air circuit breakers/molded case circuit breakers for changeover according to 60947-6-1.

For more information, see chapter "Monitoring Devices".

Busbar systems

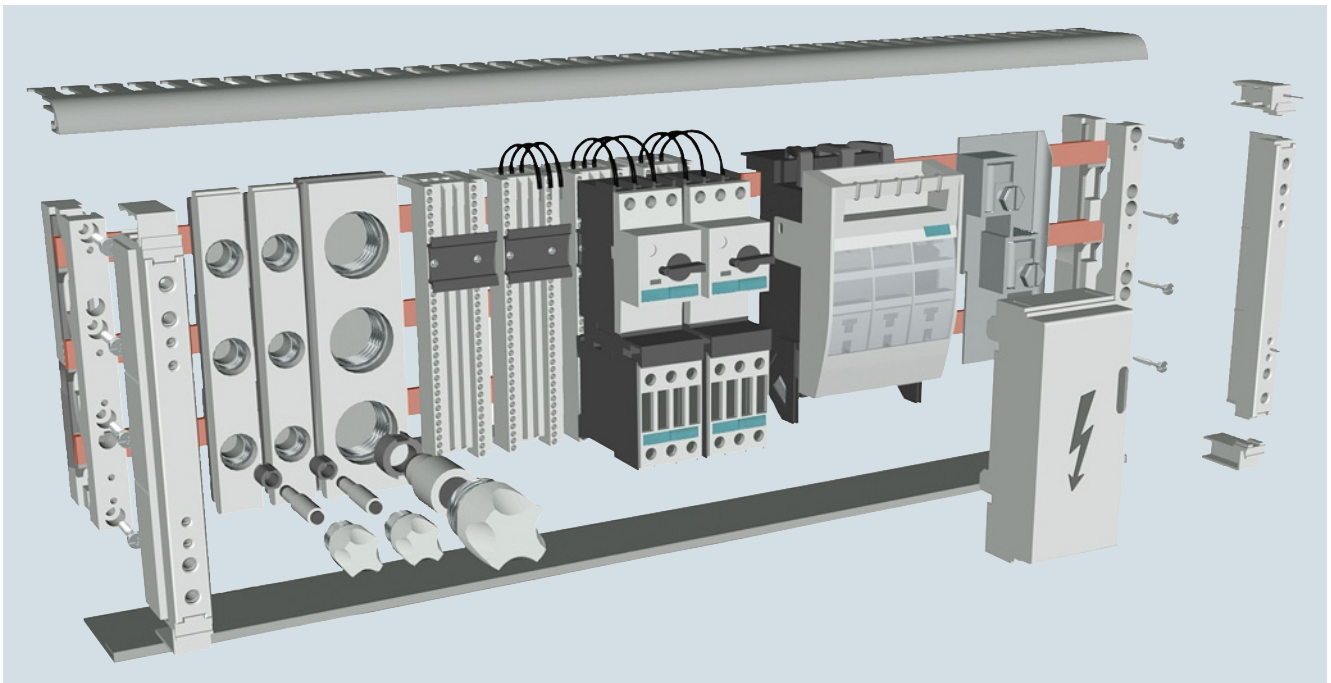

Busbar adapter systems with 40 mm or 60 mm busbar center-to-center spacing with components for busbar runs, adapters and switching device holders for individual equipment possibilities, devices with an integrated adapter, as well as accessories and flat copper profiles. Observe the short-circuit strength of the busbar system. Short-circuit strength greater than 50 kA on request.

For more information, see chapter "Busbar Systems".

Molded Case Circuit Breakers

3VL Molded Case Circuit Breakers up to 1600 A, IEC

Accessories and spare parts

2

Type	Rated current I_n A	DT	Article No. www.siemens.com/ product?Article No.	Price per PU	PU (UNIT, SET, M)	PS*/ P. unit	PG	Weight per PU approx. kg
------	--------------------------	----	--	-----------------	----------------------------	-----------------	----	-----------------------------------

Further accessories

Current transformers (-T6) for N conductor/grounded neutral point of the transformer for ground-fault protection in 4-wire three-phase systems¹⁾

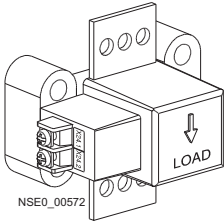

VL160/3VL2	63, 80		3VL9280-8TC00		1	1 unit	1CC	0.453
	100		3VL9210-8TC00		1	1 unit	1CC	0.460
	160		3VL9216-8TC00		1	1 unit	1CC	0.475
VL250/3VL3	200		3VL9320-8TC00		1	1 unit	1CC	0.452
	250		3VL9325-8TC00		1	1 unit	1CC	0.455
VL400/3VL4	315		3VL9440-8TC00		1	1 unit	1CC	0.648
	400		3VL9440-8TC00		1	1 unit	1CC	0.648
VL630/3VL5	630		3VL9563-8TC00		1	1 unit	1CC	0.771
VL800/3VL6	800		3VL9680-8TC00		1	1 unit	1CC	0.800
VL1250/3VL7	1000		3VL9712-8TC00		1	1 unit	1CC	2.042
	1250		3VL9712-8TC00		1	1 unit	1CC	2.042
VL1600/3VL8	1600		3VL9816-8TC00		1	1 unit	1CC	2.061

¹⁾ Please note the rated current of the circuit breaker.

Current transformers for measuring purposes



4NC53 current transformer

See also chapter "Measuring Devices and Power Monitoring", Accessories.

Version	DT	Article No. www.siemens.com/ product?Article No.	Price per PU	PU (UNIT, SET, M)	PS*/ P. unit	PG	Weight per PU approx. kg
---------	----	--	-----------------	----------------------------	-----------------	----	---------------------------------------

Accessories for communication

3- or 4-pole

Data transmission through COM20, COM21

VL160 (3VL2) to VL1600 (3VL8)

COM20 Release 2 (PROFIBUS module for 3VL molded case circuit breaker) for ETUs with communication function and LCD ETUs

Module for connecting the 3VL molded case circuit breaker to the PROFIBUS DP, including switching function and Zone Selective Interlocking functionality, connection cable to ETU included in delivery of the ETU, length 1.5 m.

3VL9000-8AU00

1 1 unit 1CC 0.287

COM21 Release 2 (MODBUS RTU module for 3VL molded case circuit breaker) for ETUs with communication function and LCD ETUs

Module for connecting the 3VL molded case circuit breaker to the MODBUS RTU, including switching function and Zone Selective Interlocking functionality, connection cable to ETU included in delivery of the ETU, length 1.5 m.

3VL9000-8AV00

1 1 unit 1CC 0.295

Connection cable ETU – COM20/COM21

For VL160 ... VL250, length 3 m
For VL630 ... VL1600, length 3 m
For VL400, length 3 m

3VL9000-8AQ81
3VL9000-8AQ71
3VL9000-8AQ61

1 1 unit 1CC 0.136
1 1 unit 1CC 0.135
1 1 unit 1CC 0.138

Addressing plugs

For assigning the PROFIBUS module addresses without using a PC/PG ▶

3UF7910-0AA00-0

1 1 unit 42J 0.015

powerconfig parameterization software

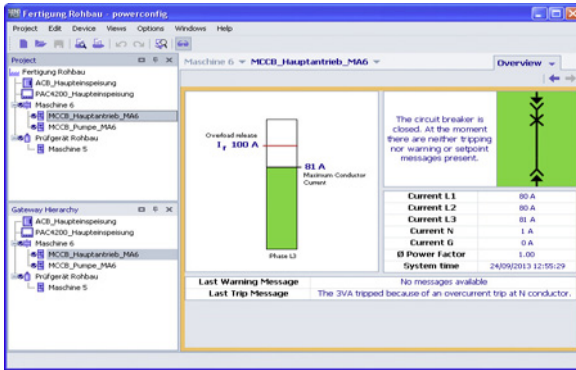

Parameterization, operation, monitoring and diagnostics of 3VL molded case circuit breakers using powerconfig software, see chapter "Software", "Configuring, Visualizing and Controlling with SENTRON". powerconfig is available free of charge at <http://support.automation.siemens.com/WWW/view/en/63452759> You can find more information on the Internet at: www.siemens.com/sentron

Communication:

- For molded case circuit breakers with communication function, see pages 2/128 to 2/144, 2/156 to 2/166.
- For more information, see chapter "Measuring Devices and Power Monitoring" and chapter "Monitoring Devices".

Molded Case Circuit Breakers

3VL Molded Case Circuit Breakers up to 1600 A, IEC

Accessories and spare parts

2

Version	DT	For VL160X (3VL1)	Price per PU	PU (UNIT, SET, M)	PS*/P. unit	PG	Weight per PU approx. kg
---------	----	-------------------	--------------	-------------------	-------------	----	--------------------------

Further accessories

3- or 4-pole

Masking frames (cover frames) For door cutouts

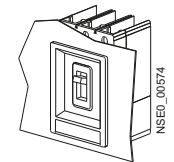

Masking frame A

A IP40	Fixed-mounted or plug-in circuit breaker	3VL9300-8BC00		1	1 unit	1CC	0.061
-------------------------	--	----------------------	--	---	--------	-----	-------

B¹⁾ IP40	Fixed-mounted, plug-in or withdrawable circuit breaker with front-operated rotary operating mechanism or motorized operating mechanism (with or without SEO/MO stored energy mechanisms)	3VL9300-8BG00		1	1 unit	1CC	0.126
--------------------------------------	--	----------------------	--	---	--------	-----	-------

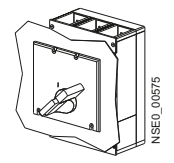

Masking frame B

C IP20	Withdrawable circuit breaker with toggle lever actuation. Assembly kit contains masking frame and extended escutcheon (cannot be used together with a motorized operating mechanism/rotary operating mechanism)	--					
-------------------------	---	----	--	--	--	--	--

D IP40	Fixed-mounted circuit breaker or plug-in circuit breaker RCD circuit breaker masking frame	3VL9300-8BD00		1	1 unit	1CC	0.046
	RCD masking frame	3VL9300-8BD00		1	1 unit	1CC	0.046

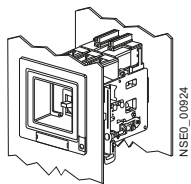

Masking frame C

E¹⁾ IP40	Circuit breaker with RCD module and front-operated rotary operating mechanism. Assembly kit contains masking frame and extended escutcheon	--					
--------------------------------------	--	----	--	--	--	--	--

	Circuit breaker with RCD module and motorized operating mechanism. Assembly kit contains masking frame and extended escutcheon	--					
--	--	----	--	--	--	--	--

Version	DT	For VL400 (3VL4)	Price per PU	PU (UNIT, SET, M)	PS*/P. unit	PG	Weight per PU approx. kg
---------	----	------------------	--------------	-------------------	-------------	----	--------------------------

Further accessories

3- or 4-pole

Masking frames (cover frames) For door cutouts

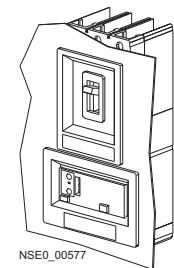

Masking frame D

A IP40	Fixed-mounted or plug-in circuit breaker	3VL9400-8BC00		1	1 unit	1CC	0.053
-------------------------	--	----------------------	--	---	--------	-----	-------

B¹⁾²⁾ IP40	Fixed-mounted, plug-in or withdrawable circuit breaker with front-operated rotary operating mechanism or motorized operating mechanism (only with SEO stored energy mechanisms)	3VL9400-8BG00		1	1 unit	1CC	0.154
--	---	----------------------	--	---	--------	-----	-------

C IP20	Withdrawable circuit breaker with toggle lever actuation. Assembly kit contains masking frame and extended escutcheon (cannot be used together with a motorized operating mechanism/rotary operating mechanism)	3VL9400-8BH00		1	1 unit	1CC	0.468
-------------------------	---	----------------------	--	---	--------	-----	-------

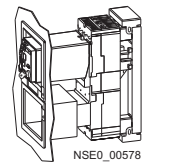

Masking frame E

D IP40	Fixed-mounted circuit breaker or plug-in circuit breaker RCD circuit breaker masking frame	3VL9400-8BC00		1	1 unit	1CC	0.053
	RCD masking frame	3VL9400-8BD00		1	1 unit	1CC	0.044

E¹⁾ IP40	Circuit breaker with RCD module and front-operated rotary operating mechanism. Assembly kit contains masking frame and extended escutcheon	3VL9400-8BH00		1	1 unit	1CC	0.468
--------------------------------------	--	----------------------	--	---	--------	-----	-------

	Circuit breaker with RCD module and motorized operating mechanism. Assembly kit contains masking frame and extended escutcheon	3VL9400-8BJ00		1	1 unit	1CC	0.396
--	--	----------------------	--	---	--------	-----	-------

¹⁾ For withdrawable version IP20.

²⁾ As motorized operating mechanism (without stored energy mechanism) for the 3VL4-3VL6, use article No. 3VL9300-8BG00.

Molded Case Circuit Breakers

3VL Molded Case Circuit Breakers up to 1600 A, IEC

Accessories and spare parts

2

DT	For VL160 (3VL2)	Price per PU	PU (UNIT, SET, M)	PS*/ P. unit	PG	Weight per PU approx. kg	DT	For VL250 (3VL3)	Price per PU	PU (UNIT, SET, M)	PS*/ P. unit	PG	Weight per PU approx. kg
	Article No. www.siemens.com/product?Article.No.							Article No. www.siemens.com/product?Article.No.					
	3VL9300-8BC00		1	1 unit	1CC	0.061		3VL9300-8BC00		1	1 unit	1CC	0.061
	3VL9300-8BG00		1	1 unit	1CC	0.126		3VL9300-8BG00		1	1 unit	1CC	0.126
	3VL9300-8BH00		1	1 unit	1CC	0.332		3VL9300-8BH00		1	1 unit	1CC	0.332
	3VL9300-8BC00 3VL9300-8BD00		1 1	1 unit 1 unit	1CC 1CC	0.061 0.046		3VL9300-8BC00 3VL9300-8BD00		1 1	1 unit 1 unit	1CC 1CC	0.061 0.046
	3VL9300-8BH00		1	1 unit	1CC	0.332		3VL9300-8BH00		1	1 unit	1CC	0.332
	3VL9300-8BJ00		1	1 unit	1CC	0.314		3VL9300-8BJ00		1	1 unit	1CC	0.314

DT	For VL630 (3VL5)	Price per PU	PU (UNIT, SET, M)	PS*/ P. unit	PG	Weight per PU approx. kg	DT	For VL800 (3VL6)	Price per PU	PU (UNIT, SET, M)	PS*/ P. unit	PG	Weight per PU approx. kg
	Article No. www.siemens.com/product?Article.No.							Article No. www.siemens.com/product?Article.No.					
	3VL9600-8BC00		1	1 unit	1CC	0.076		3VL9600-8BC00		1	1 unit	1CC	0.076
	3VL9600-8BG00		1	1 unit	1CC	0.209		3VL9600-8BG00		1	1 unit	1CC	0.209
	3VL9600-8BH00		1	1 unit	1CC	0.343		3VL9600-8BH00		1	1 unit	1CC	0.343
	--							--					
	--							--					
	--							--					
	--							--					

Molded Case Circuit Breakers

3VL Molded Case Circuit Breakers up to 1600 A, IEC

Accessories and spare parts

2

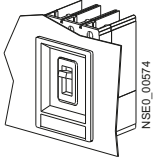
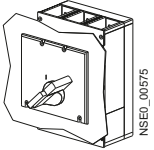
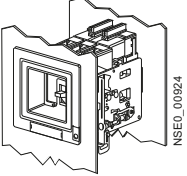
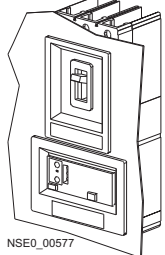
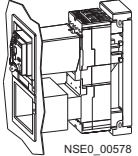
Version	DT	For VL1250 (3VL7) Article No. www.siemens.com/ product?Article No.	Price per PU	PU (UNIT, SET, M)	PS*/ P. unit	PG	Weight per PU approx. kg
Further accessories							
3- or 4-pole Masking frames (cover frames) For door cutouts							
 Masking frame A NSE0_00574	A	Fixed-mounted or plug-in circuit breaker IP40		3VL9800-8BC00	1	1 unit	1CC 0.064
 Masking frame B NSE0_00575	B¹⁾	Fixed-mounted, plug-in or withdrawable circuit breaker with front-operated rotary operating mechanism or motorized operating mechanism IP40		3VL9800-8BG00	1	1 unit	1CC 0.278
 Masking frame C NSE0_00924	C	Withdrawable circuit breaker with toggle lever actuation. Assembly kit contains masking frame and extended escutcheon (cannot be used together with a motorized operating mechanism/rotary operating mechanism) IP20		3VL9800-8BH00	1	1 unit	1CC 0.575
 Masking frame D NSE0_00577	D	Fixed-mounted circuit breaker or plug-in circuit breaker RCD circuit breaker masking frame RCD masking frame IP40	-- --				
 Masking frame E NSE0_00578	E¹⁾	Circuit breaker with RCD module and front-operated rotary operating mechanism. Assembly kit contains masking frame and extended escutcheon Circuit breaker with RCD module and motorized operating mechanism. Assembly kit contains masking frame and extended escutcheon IP40	-- --				

¹⁾ For withdrawable version IP20.

Molded Case Circuit Breakers

3VL Molded Case Circuit Breakers up to 1600 A, IEC

Accessories and spare parts

2

DT	For VL1600 (3VL8)	Price per PU	PU (UNIT, SET, M)	PS* / P. unit	PG	Weight per PU approx. kg
	Article No. www.siemens.com/product?Article.No.					
	3VL9800-8BC00		1	1 unit	1CC	0.064
	3VL9800-8BG00		1	1 unit	1CC	0.278
	3VL9800-8BH00		1	1 unit	1CC	0.575
	--					
	--					
	--					
	--					

Molded Case Circuit Breakers

3VL Molded Case Circuit Breakers up to 1600 A, IEC

Accessories and spare parts

More information

Manual for the 3VL molded case circuit breaker

This manual contains additional technical information, covering a product description, mode of operation, electrical wiring system and retrofitting.

The manual and operating instructions are available in PDF format at:

www.siemens.com/lowvoltage/manuals

SENTRON manual for communication solutions

Free download from
www.siemens.com/lowvoltage/manuals

See chapter "Air Circuit Breakers",
"3WL Air Circuit Breakers/Non-Automatic Air Circuit Breakers
up to 6300 A (AC), IEC, "Accessories and spare parts".

Note

You will find the 3VL molded case circuit breakers up to 1600 A according to UL 489 from [page 2/214 onwards](#).

Molded Case Circuit Breakers

3VL Molded Case Circuit Breakers up to 1600 A, according to UL 489

Introduction

Overview

2



Type VL150X UL, CG frame VL150 UL, DG frame VL250 UL, FG frame VL400 UL, JG frame

Molded case circuit breakers

3VL molded case circuit breakers up to 1600 A, according to UL 489

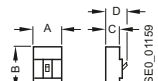
	A	20 to 150	50 to 150	100 to 250	250 to 400
Rated current $I_n^{1)}$ at 40 °C ambient temperature	A	20 to 150	50 to 150	100 to 250	250 to 400
Number of poles		3	3	3	3
Rated operational voltage U_e (UL) 50/60 Hz AC	V	480, 600/347	480, 600/347	400, 600/347	600
DC ²⁾	V	250	500	500	500
Overcurrent release					
Thermal-magnetic		✓	✓	✓	✓
Electronic, ETU with setting knobs		--	✓	✓	✓
Electronic LCD ETU		--	✓	✓	✓
Dimensions					
					
A	mm	105	105	105	139
B	mm	157	175	175	279
C	mm	81	81	81	102
D	mm	107	107	107	138

Breaking capacity

Standard breaking capacity N

Up to 240 V AC	kA	65	65	65	65
Up to 480 V AC	kA	35	35	35	35
Up to 600 V AC	kA	--	--	--	25
Up to 600/347 V AC	kA	10	18	18	--
Up to 250 V DC ³⁾	kA	30	30	30	30
Up to 500 V DC ^{3) 4)}	kA	--	18	18	25
Breaking capacity I_{cu}/I_{cs} RMS value according to IEC 60947-2					
Up to 240 V AC	kA	65/65	65/65	65/65	65/65
Up to 415 V AC	kA	40/40	40/40	40/40	45/45
Up to 690 V AC	kA	8/4 ⁵⁾	12/6	12/6	12/6
Up to 250 V DC ³⁾	kA	30/30	30/30	30/30	30/30

High breaking capacity H

Up to 240 V AC	kA	100	100	100	100
Up to 480 V AC	kA	65	65	65	65
Up to 600 V AC	kA	--	--	--	25
Up to 600/347 V AC	kA	10	18	18	--
Up to 250 V DC ³⁾	kA	30	30	30	30
Up to 500 V DC ^{3) 4)}	kA	--	18	25	35
Breaking capacity I_{cu}/I_{cs} RMS value according to IEC 60947-2					
Up to 240 V AC	kA	100/75	100/75	100/75	100/75
Up to 415 V AC	kA	70/70	70/70	70/70	70/70
Up to 690 V AC	kA	10/5 ⁵⁾	12/6	12/6	15/8
Up to 250 V DC ³⁾	kA	30/30	30/30	30/30	30/30

Very high breaking capacity L

Up to 240 V AC	kA	--	200	200	200
Up to 480 V AC	kA	--	100	100	100
Up to 600 V AC	kA	--	--	--	25
Up to 600/347 V AC	kA	--	18	18	--
Up to 250 V DC ³⁾	kA	--	30	30	30
Up to 500 V DC ^{3) 4)}	kA	--	18	30	35
Breaking capacity I_{cu}/I_{cs} RMS value according to IEC 60947-2					
Up to 240 V AC	kA	--	200/150	200/150	200/150
Up to 415 V AC	kA	--	100/75	100/75	100/75
Up to 690 V AC	kA	--	12/6	12/6	15/8
Up to 250 V DC ³⁾	kA	--	30/30	30/30	30/30

✓ Available -- Not available

1) 80 % rated current applications according to UL 489, 100 % rated current applications according to IEC 60947-2.

2) Rated DC voltage applies only for molded case circuit breakers with thermal-magnetic release.



VL400X UL, LG frame



VL800 UL, MG frame



VL1200 UL, NG frame



VL1600 UL, PG frame

3VL molded case circuit breakers up to 1600 A, according to UL 489

400 to 600 600 to 800 800 to 1200 1200 to 1600

3	3	3	3
600 500	600 500	600 500	600 500
✓ ✓ ✓	✓ ✓ ✓	✓ ✓ ✓	✓ ✓ ✓
139 279 102 138	190 406 118 151	229 406 157 209	229 406 157 209

65 35 18 -- 30 25	65 35 25 -- 22 35	65 35 25 -- 22 35	65 35 25 -- 22 35
65/65 45/45 12/6 30/30	65/65 50/50 20/10 30/30	65/35 50/25 20/10 30/30	65/35 50/25 20/10 30/30

100 65 18 -- 30 35	100 65 35 -- 25 50	100 65 35 -- 25 50	100 65 35 -- 25 50
100/75 70/70 15/8 30/30	100/75 70/70 20/10 30/30	100/50 70/35 30/15 30/30	100/50 70/35 30/15 30/30

200 100 18 -- 30 35	200 100 50 -- 42 65	200 100 65 -- 42 65	200 100 65 -- 42 65
200/150 100/75 15/8 30/30	200/150 100/75 20/10 30/30	200/100 100/50 35/17 30/30	200/100 100/50 35/17 30/30

³⁾ The maximum permitted DC voltage for each conducting path needs to be taken into account for DC switching applications.
⁴⁾ 500 V DC rated / 600 V DC max. for use in ungrounded UPS DC applications (according to UL 489, Supplement SC)
⁵⁾ Rated current $I_n \geq 25$ A.

Molded Case Circuit Breakers

3VL Molded Case Circuit Breakers up to 1600 A, according to UL 489

Introduction

2

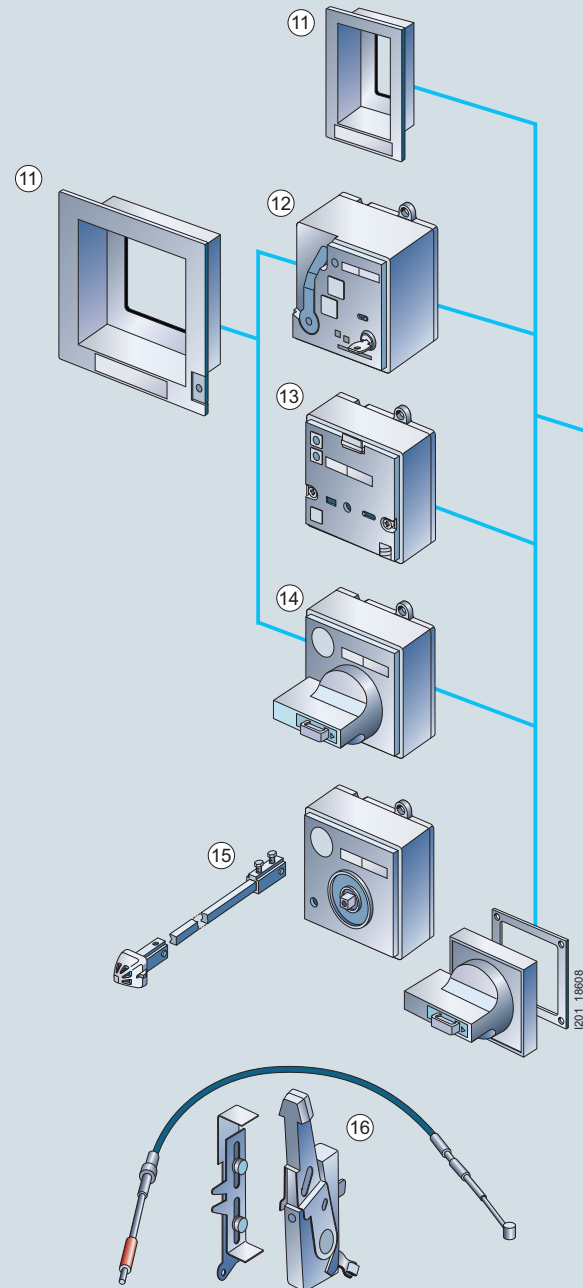

- ① Standard terminal cover
- ② Extended terminal cover
- ③ Phase barriers
- ④ Side panels of the withdrawable unit
- ⑤ Box terminal for Cu
- ⑥ Multiple feed-in terminal for Al/Cu (size-dependent)
- ⑦ Circular conductor terminal for Al/Cu
- ⑧ Withdrawable/plug-in base
- ⑨ Internal accessories
- ⑩ 3VL molded case circuit breakers
- ⑪ Masking frame/cover frame for door cutout
- ⑫ Motorized operating mechanism with stored energy mechanism (SEO), only CG frame to MG frame
- ⑬ Motorized operating mechanism (MO), only NG frame and PG frame
- ⑭ Front-operated rotary operating mechanism
- ⑮ Door-coupling rotary operating mechanism
- ⑯ Max Flex operating mechanism
- ⑰ Battery power supply with test function for electronic release
- ⑱ Thermal-magnetic release
- ⑲ Electronic Trip Unit with LCD (LCD ETU)
- ⑳ Electronic Trip Unit with setting knobs (ETU)
- ㉑ Communication module COM20/21 (Release 2)
- ㉒ Rear terminals – flat and round

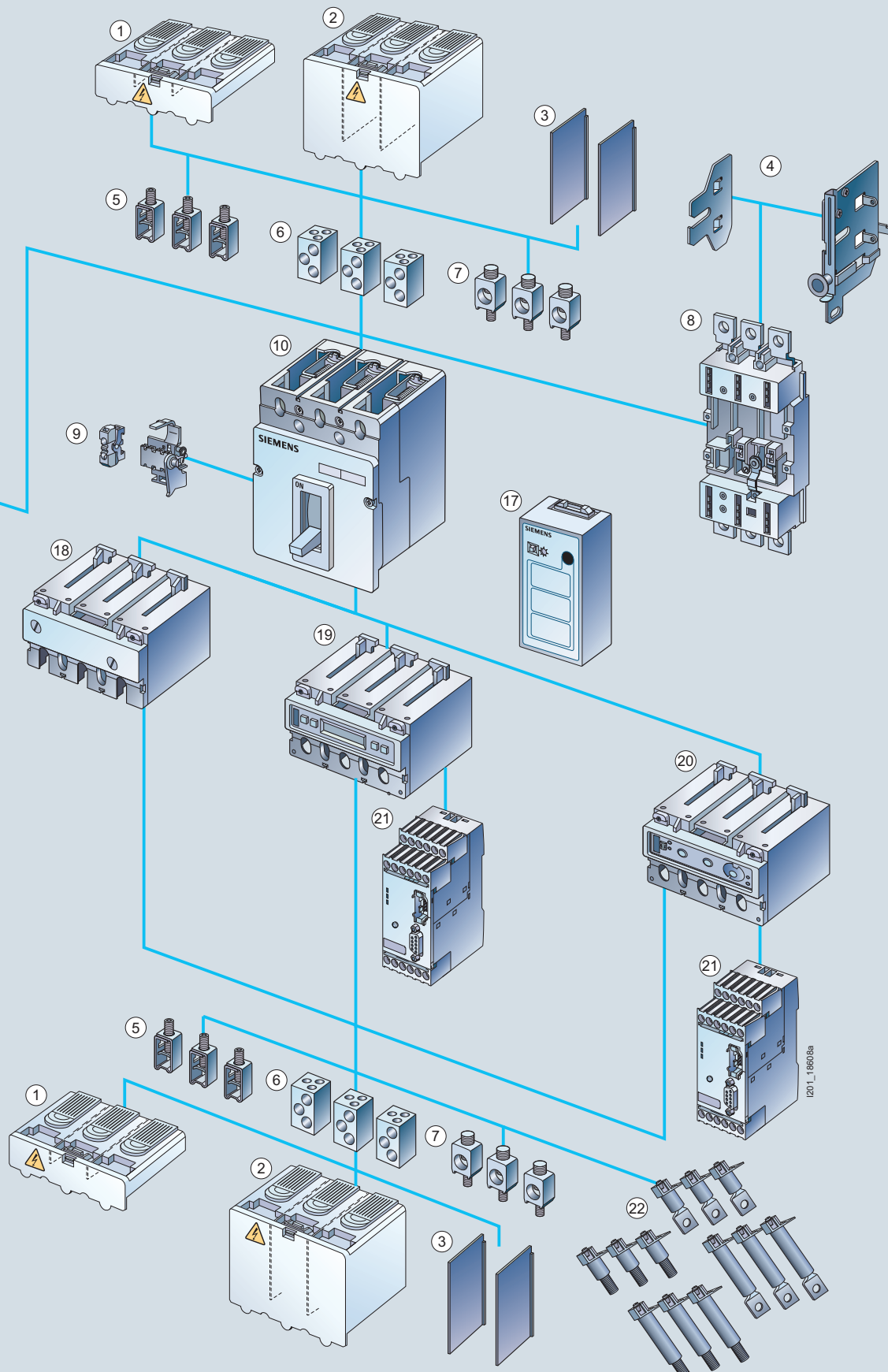

Molded Case Circuit Breakers

3VL Molded Case Circuit Breakers up to 1600 A, according to UL 489

Introduction

Benefits

2



- 3VL molded case circuit breakers according to UL 489 optimally fulfill the high demands prevalent in modern power distribution.
- The molded case circuit breakers have a compact design and at the same time a high breaking capacity of up to 100 kA at 480 V.
- They are available both in thermal-magnetic (20 A to 1600 A) and in electronic versions (60 A to 1600 A).
- Via PROFIBUS DP and Modbus RTU, the molded case circuit breakers with Electronic Trip Units (ETUs) are consistently communication-capable.

Application

The different versions of 3VL molded case circuit breakers according to UL are suitable for the following applications:

- Incoming circuit breakers (feeders) and outgoing circuit breakers (branches) in distribution systems
- Switching and protection devices for motors (motor protection in combination with a contactor and motor protection relay), transformers and capacitors
- Disconnecting means with features for stopping and switching off in an emergency (main disconnecting means and EMERGENCY-STOP switches) in conjunction with lockable rotary operating mechanisms.

The 3VL molded case circuit breakers according to UL are available in the following versions:

1. For line protection
The overload and short-circuit releases are designed for the protection of cables, leads and non-motor loads.
2. For starter combinations
These molded case circuit breakers are used both for short-circuit protection as well as for isolating functions, which may be required in starter combinations consisting of molded case circuit breakers, overload relays and motor contactors. These molded case circuit breakers exclusively feature adjustable, instantaneous short-circuit releases.
3. As non-automatic circuit breakers
These molded case circuit breakers can be used as feeder circuit breakers, main control switches or non-automatic circuit breakers without overload protection. They incorporate an integrated short-circuit self-protection system.

Breaking capacity

- N** Molded case circuit breakers with standard breaking capacity N (up to 35 kA at 480 V)
- H** Molded case circuit breakers with high breaking capacity H (up to 65 kA at 480 V)
- L** Molded case circuit breakers with very high breaking capacity L (up to 100 kA at 480 V)

Standards and specifications

3VL molded case circuit breakers according to UL comply with:

UL 489,
 CSA (CSA C22.2 No. 5),
 IEC/EN 60947-2,
 For isolating features according to IEC 60947-2, EN 60947-2, NOM (NMJ-J-266-ANCE), please inquire.
 CCC (only VL2 UL/DG, VL3 UL/FG, VL4 UL/JG and VL4X UL/LG)
 GOST and FireSafety (Russia)

The 3VL UL molded case circuit breakers comply in addition with requirements for "disconnecting means with features for stopping and switching off in an emergency" (EMERGENCY-STOP switches) in conjunction with lockable rotary operating mechanisms (red-yellow).

Please contact Siemens for details of other standards.

Operating conditions

The 3VL molded case circuit breakers according to UL are designed for operation in enclosed areas.

Molded Case Circuit Breakers

3VL Molded Case Circuit Breakers up to 1600 A, according to UL 489

3-pole

Selection and ordering data

Type	Rated current I_n	Current setting of the inverse-time delayed overload protection "L" I_r	Operating current of the instantaneous short-circuit protection "I" I_i	DT	Standard breaking capacity N, up to 35 kA at 480 V <small>see "Overview".</small>					
					Article No. www.siemens.com/product?Article No.	Price per PU	PU (UNIT, SET, M)	PS*/P. unit	PG	Weight per PU approx. kg
	A	A	A		Article No. supplement required, see page 2/236					

Fixed-mounted molded case circuit breakers, VL150X UL (CG frame) up to VL1600 UL (PG frame), thermal-magnetic releases (UL file: E10848, CCN¹⁾: DIVQ



Line protection, TM, LI function

With non-adjustable thermal overcurrent releases, adjustable short-circuit releases,

VL150X UL: non-adjustable short-circuit releases

Connection type:

Molded case circuit breakers without preassembled connections, connections must be ordered under "Accessories", "Plug-in versions/withdrawable versions", [pages 2/251 to 2/254](#) or under "Accessories", "Connection parts for fixed-mounted molded case circuit breakers", [pages 2/255 to 2/262](#).

VL150X UL, CG frame	20	20	300	3VL1102-1KN30-□□□□	1	1 unit	1CC	1,900
	25	25	300	3VL1125-1KN30-□□□□	1	1 unit	1CC	2,000
	30	30	300	3VL1103-1KN30-□□□□	1	1 unit	1CC	2,000
	35	35	600	3VL1135-1KN30-□□□□	1	1 unit	1CC	2,000
	40	40	600	3VL1104-1KN30-□□□□	1	1 unit	1CC	2,000
	50	50	600	3VL1105-1KN30-□□□□	1	1 unit	1CC	2,000
	60	60	600	3VL1106-1KN30-□□□□	1	1 unit	1CC	2,000
	70	70	1000	3VL1107-1KN30-□□□□	1	1 unit	1CC	2,000
	80	80	1000	3VL1108-1KN30-□□□□	1	1 unit	1CC	2,000
	90	90	1000	3VL1191-1KN30-□□□□	1	1 unit	1CC	2,000
	100	100	1000	3VL1110-1KN30-□□□□	1	1 unit	1CC	2,000
	125	125	1000	3VL1112-1KN30-□□□□	1	1 unit	1CC	2,000
150	150	1500	3VL1115-1KN30-□□□□	1	1 unit	1CC	2,000	
VL150 UL, DG frame	50	50	450 ... 700	3VL2505-1KN30-□□□□	1	1 unit	1CC	2,200
	60	60	450 ... 700	3VL2506-1KN30-□□□□	1	1 unit	1CC	2,200
	70	70	450 ... 700	3VL2507-1KN30-□□□□	1	1 unit	1CC	2,200
	80	80	450 ... 800	3VL2508-1KN30-□□□□	1	1 unit	1CC	2,200
	90	90	500 ... 1000	3VL2591-1KN30-□□□□	1	1 unit	1CC	2,200
	100	100	500 ... 1000	3VL2510-1KN30-□□□□	1	1 unit	1CC	2,200
	110	110	550 ... 1100	3VL2511-1KN30-□□□□	1	1 unit	1CC	2,200
VL250 UL, FG frame	100	100	625 ... 1250	3VL3510-1KN30-□□□□	1	1 unit	1CC	2,300
	110	110	800 ... 1600	3VL3511-1KN30-□□□□	1	1 unit	1CC	2,300
	125	125	800 ... 1600	3VL3512-1KN30-□□□□	1	1 unit	1CC	2,300
	150	150	800 ... 1600	3VL3515-1KN30-□□□□	1	1 unit	1CC	2,300
	175	175	1000 ... 2000	3VL3517-1KN30-□□□□	1	1 unit	1CC	2,300
	200	200	1000 ... 2000	3VL3520-1KN30-□□□□	1	1 unit	1CC	2,300
	225	225	1250 ... 2500	3VL3522-1KN30-□□□□	1	1 unit	1CC	2,300
250	250	1250 ... 2500	3VL3525-1KN30-□□□□	1	1 unit	1CC	2,300	
VL400 UL, JG frame	250	250	1250 ... 2500	3VL4125-1KN30-□□□□	1	1 unit	1CC	5,700
	300	300	1500 ... 3000	3VL4130-1KN30-□□□□	1	1 unit	1CC	5,700
	350	350	1750 ... 3500	3VL4135-1KN30-□□□□	1	1 unit	1CC	5,700
	400	400	2000 ... 4000	3VL4140-1KN30-□□□□	1	1 unit	1CC	5,700
VL400X UL, LG frame	400	400	2000 ... 4000	3VL4840-1KN30-□□□□	1	1 unit	1CC	5,700
	500	500	2500 ... 5000	3VL4850-1KN30-□□□□	1	1 unit	1CC	5,700
	600	600	2750 ... 5500	3VL4860-1KN30-□□□□	1	1 unit	1CC	5,700
VL800 UL, MG frame	600	600	3000 ... 6000	3VL6160-1KN30-□□□□	1	1 unit	1CC	14,000
	700	700	3250 ... 6500	3VL6170-1KN30-□□□□	1	1 unit	1CC	14,000
	800	800	3250 ... 6500	3VL6180-1KN30-□□□□	1	1 unit	1CC	14,000
VL1200 UL, NG frame	800	800	4000 ... 8000	3VL7180-1KN30-□□□□	1	1 unit	1CC	21,800
	900	900	5000 ... 10000	3VL7190-1KN30-□□□□	1	1 unit	1CC	21,800
	1000	1000	5000 ... 10000	3VL7110-1KN30-□□□□	1	1 unit	1CC	21,800
	1200	1200	7000 ... 12000	3VL7112-1KN30-□□□□	1	1 unit	1CC	21,800
VL1600 UL, PG frame ²⁾	1200	1200	7000 ... 12000	3VL8112-1KN30-□□□□	1	1 unit	1CC	32,800
	1400	1400	7000 ... 12000	3VL8114-1KN30-□□□□	1	1 unit	1CC	32,800
	1600	1600	7000 ... 12000	3VL8116-1KN30-□□□□	1	1 unit	1CC	32,800

¹⁾ UL Category Code Number.

²⁾ Operation of the molded case circuit breaker within the scope of application of UL 489/CSA is permitted only in conjunction with the mounting base ([see page 2/262](#)).

Molded Case Circuit Breakers

3VL Molded Case Circuit Breakers up to 1600 A, according to UL 489

3-pole

2

DT	High breaking capacity H, up to 65 kA at 480 V					(H)	DT	Very high breaking capacity L, up to 100 kA at 480 V					(L)
	Article No. www.siemens.com/ product?Article No. Article No. supplement required, see page 2/236	Price per PU	PU (UNIT, SET, M)	PS* P. unit	PG	Weight per PU approx. kg		Article No. www.siemens.com/ product?Article No. Article No. supplement required, see page 2/236	Price per PU	PU (UNIT, SET, M)	PS* P. unit	PG	Weight per PU approx. kg

3VL1102-2KN30-□□□□	1	1 unit	1CC	2.000	--				
3VL1125-2KN30-□□□□	1	1 unit	1CC	2.000	--				
3VL1103-2KN30-□□□□	1	1 unit	1CC	2.000	--				
3VL1135-2KN30-□□□□	1	1 unit	1CC	2.000	--				
3VL1104-2KN30-□□□□	1	1 unit	1CC	2.000	--				
3VL1105-2KN30-□□□□	1	1 unit	1CC	2.000	--				
3VL1106-2KN30-□□□□	1	1 unit	1CC	2.000	--				
3VL1107-2KN30-□□□□	1	1 unit	1CC	2.000	--				
3VL1108-2KN30-□□□□	1	1 unit	1CC	2.000	--				
3VL1191-2KN30-□□□□	1	1 unit	1CC	2.000	--				
3VL1110-2KN30-□□□□	1	1 unit	1CC	2.000	--				
3VL1112-2KN30-□□□□	1	1 unit	1CC	2.000	--				
3VL1115-2KN30-□□□□	1	1 unit	1CC	2.000	--				
3VL2505-2KN30-□□□□	1	1 unit	1CC	2.200	3VL2505-3KN30-□□□□	1	1 unit	1CC	2.200
3VL2506-2KN30-□□□□	1	1 unit	1CC	2.200	3VL2506-3KN30-□□□□	1	1 unit	1CC	2.200
3VL2507-2KN30-□□□□	1	1 unit	1CC	2.200	3VL2507-3KN30-□□□□	1	1 unit	1CC	2.200
3VL2508-2KN30-□□□□	1	1 unit	1CC	2.200	3VL2508-3KN30-□□□□	1	1 unit	1CC	2.200
3VL2591-2KN30-□□□□	1	1 unit	1CC	2.200	3VL2591-3KN30-□□□□	1	1 unit	1CC	2.200
3VL2510-2KN30-□□□□	1	1 unit	1CC	2.200	3VL2510-3KN30-□□□□	1	1 unit	1CC	2.200
3VL2511-2KN30-□□□□	1	1 unit	1CC	2.200	3VL2511-3KN30-□□□□	1	1 unit	1CC	2.200
3VL2512-2KN30-□□□□	1	1 unit	1CC	2.200	3VL2512-3KN30-□□□□	1	1 unit	1CC	2.200
3VL2515-2KN30-□□□□	1	1 unit	1CC	2.200	3VL2515-3KN30-□□□□	1	1 unit	1CC	2.200
3VL3510-2KN30-□□□□	1	1 unit	1CC	2.300	3VL3510-3KN30-□□□□	1	1 unit	1CC	2.300
3VL3511-2KN30-□□□□	1	1 unit	1CC	2.300	3VL3511-3KN30-□□□□	1	1 unit	1CC	2.300
3VL3512-2KN30-□□□□	1	1 unit	1CC	2.300	3VL3512-3KN30-□□□□	1	1 unit	1CC	2.300
3VL3515-2KN30-□□□□	1	1 unit	1CC	2.300	3VL3515-3KN30-□□□□	1	1 unit	1CC	2.300
3VL3517-2KN30-□□□□	1	1 unit	1CC	2.300	3VL3517-3KN30-□□□□	1	1 unit	1CC	2.300
3VL3520-2KN30-□□□□	1	1 unit	1CC	2.300	3VL3520-3KN30-□□□□	1	1 unit	1CC	2.300
3VL3522-2KN30-□□□□	1	1 unit	1CC	2.300	3VL3522-3KN30-□□□□	1	1 unit	1CC	2.300
3VL3525-2KN30-□□□□	1	1 unit	1CC	2.300	3VL3525-3KN30-□□□□	1	1 unit	1CC	2.300
3VL4125-2KN30-□□□□	1	1 unit	1CC	5.700	3VL4125-3KN30-□□□□	1	1 unit	1CC	5.700
3VL4130-2KN30-□□□□	1	1 unit	1CC	5.700	3VL4130-3KN30-□□□□	1	1 unit	1CC	5.700
3VL4135-2KN30-□□□□	1	1 unit	1CC	5.700	3VL4135-3KN30-□□□□	1	1 unit	1CC	5.700
3VL4140-2KN30-□□□□	1	1 unit	1CC	5.700	3VL4140-3KN30-□□□□	1	1 unit	1CC	5.700
3VL4840-2KN30-□□□□	1	1 unit	1CC	5.700	3VL4840-3KN30-□□□□	1	1 unit	1CC	5.700
3VL4850-2KN30-□□□□	1	1 unit	1CC	5.700	3VL4850-3KN30-□□□□	1	1 unit	1CC	5.700
3VL4860-2KN30-□□□□	1	1 unit	1CC	5.700	3VL4860-3KN30-□□□□	1	1 unit	1CC	5.700
3VL6160-2KN30-□□□□	1	1 unit	1CC	14.000	3VL6160-3KN30-□□□□	1	1 unit	1CC	14.000
3VL6170-2KN30-□□□□	1	1 unit	1CC	14.000	3VL6170-3KN30-□□□□	1	1 unit	1CC	14.000
3VL6180-2KN30-□□□□	1	1 unit	1CC	14.000	3VL6180-3KN30-□□□□	1	1 unit	1CC	14.000
3VL7180-2KN30-□□□□	1	1 unit	1CC	21.800	3VL7180-3KN30-□□□□	1	1 unit	1CC	21.800
3VL7190-2KN30-□□□□	1	1 unit	1CC	21.800	3VL7190-3KN30-□□□□	1	1 unit	1CC	21.800
3VL7110-2KN30-□□□□	1	1 unit	1CC	21.800	3VL7110-3KN30-□□□□	1	1 unit	1CC	21.800
3VL7112-2KN30-□□□□	1	1 unit	1CC	21.800	3VL7112-3KN30-□□□□	1	1 unit	1CC	21.800
3VL8112-2KN30-□□□□	1	1 unit	1CC	32.800	3VL8112-3KN30-□□□□	1	1 unit	1CC	32.800
3VL8114-2KN30-□□□□	1	1 unit	1CC	32.800	3VL8114-3KN30-□□□□	1	1 unit	1CC	32.800
3VL8116-2KN30-□□□□	1	1 unit	1CC	32.800	3VL8116-3KN30-□□□□	1	1 unit	1CC	32.800

Molded Case Circuit Breakers

3VL Molded Case Circuit Breakers up to 1600 A, according to UL 489

3-pole

2

Type	Rated current I_n	Operating current of the instantaneous short-circuit protection "I" I_i	DT	Standard breaking capacity N, up to 35 kA at 480 V see "Overview".	(N)
	A	A		Article No. www.siemens.com/product?ArticleNo Article No. supplement required, see page 2/236	Price per PU PU (UNIT, SET, M) PS*/P. unit PG Weight per PU approx. kg

Fixed-mounted molded case circuit breakers, VL150 UL (DG frame) to VL1600 UL (PG frame), magnetic and Electronic Trip Units



NSE0_00707

Molded case circuit breakers for starter combination, I function (motor circuit protectors; UL file: E10848, CCN¹⁾: DKPUZ²⁾

Without overcurrent release, with adjustable short-circuit release

Connection type:

Molded case circuit breakers without preassembled connections, connections must be ordered under "Accessories", "Plug-in versions/withdrawable versions", pages 2/251 to 2/254 or under "Accessories", "Connection parts for fixed-mounted molded case circuit breakers", pages 2/255 to 2/262.

VL150 UL, DG frame	150 150 150	450 ... 900 750 ... 1500 1250 ... 2500	---	
VL250 UL, FG frame	250 250 250	600 ... 1200 1000 ... 2000 1750 ... 3500	---	
VL400 UL, JG frame	400 400 ³⁾	1250 ... 2500 2000 ... 4000	---	
VL400X UL, LG frame	600 600 ³⁾	2000 ... 4000 2750 ... 5500	---	
VL800 UL, MG frame	800	3250 ... 6500	---	
VL1200 UL, NG frame	1200	7000 ... 12000	---	



NSE0_00708

Non-automatic molded case circuit breakers (molded case switches; UL file: E68312, CCN¹⁾: WJAZ)

Without overcurrent release, with non-adjustable short-circuit release (for intrinsic protection only)

Connection type:

Molded case circuit breakers without preassembled connections, connections must be ordered under "Accessories", "Plug-in versions/withdrawable versions", pages 2/251 to 2/254 or under "Accessories", "Connection parts for fixed-mounted molded case circuit breakers", pages 2/255 to 2/262.

VL150X UL, CG frame	100 150	1800 1800	3VL1110-1KE30-□□□□ 3VL1115-1KE30-□□□□	1 1	1 unit 1 unit	1CC 1CC	2.000 2.000
VL150 UL, DG frame	150	2500	---				
VL250 UL, FG frame	250	3500	---				
VL400 UL, JG frame	400	4400	---				
VL400X UL, LG frame	600	5500	---				
VL800 UL, MG frame	800	6500	---				
VL1200 UL, NG frame	1200	12000	---				
VL1600 UL, PG frame ⁴⁾	1600	14000	---				

¹⁾ UL Category Code Number.

²⁾ UL-recognized.

³⁾ Motor current according to NEC 430-110.

⁴⁾ Operation of the molded case circuit breaker within the scope of application of UL 489/CSA is permitted only in conjunction with the mounting base (see page 2/262).

Molded Case Circuit Breakers

3VL Molded Case Circuit Breakers up to 1600 A, according to UL 489

3-pole

2

DT	High breaking capacity H, up to 65 kA at 480 V					(H)	DT	Very high breaking capacity L, up to 100 kA at 480 V					(L)
	Article No. www.siemens.com/ product?Article No. Article No. supplement required, see page 2/236	Price per PU	PU (UNIT, SET, M)	PS*/ P. unit	PG	Weight per PU approx.		Article No. www.siemens.com/ product?Article No. Article No. supplement required, see page 2/236	Price per PU	PU (UNIT, SET, M)	PS*/ P. unit	PG	Weight per PU approx.
						kg							kg

3VL2515-2KJ30-□□□□	1	1 unit	1CC	2.200	--	
3VL2515-2KK30-□□□□	1	1 unit	1CC	2.200	--	
3VL2515-2KL30-□□□□	1	1 unit	1CC	2.200	--	
3VL3525-2KJ30-□□□□	1	1 unit	1CC	2.300	--	
3VL3525-2KK30-□□□□	1	1 unit	1CC	2.300	--	
3VL3525-2KL30-□□□□	1	1 unit	1CC	2.300	--	
3VL4140-2KJ30-□□□□	1	1 unit	1CC	5.700	--	
3VL4140-2KK30-□□□□	1	1 unit	1CC	5.700	--	
3VL4860-2KJ30-□□□□	1	1 unit	1CC	5.700	--	
3VL4860-2KK30-□□□□	1	1 unit	1CC	5.700	--	
3VL6180-2KK30-□□□□	1	1 unit	1CC	14.000	--	
3VL7112-2KK30-□□□□	1	1 unit	1CC	21.800	--	

3VL1110-2KE30-□□□□	1	1 unit	1CC	2.000	--				
3VL1115-2KE30-□□□□	1	1 unit	1CC	2.000	--				
3VL2515-2KE30-□□□□	1	1 unit	1CC	2.200	3VL2515-3KE30-□□□□	1	1 unit	1CC	2.200
3VL3525-2KE30-□□□□	1	1 unit	1CC	2.300	3VL3525-3KE30-□□□□	1	1 unit	1CC	2.300
3VL4140-2KE30-□□□□	1	1 unit	1CC	5.700	3VL4140-3KE30-□□□□	1	1 unit	1CC	5.700
3VL4860-2KE30-□□□□	1	1 unit	1CC	5.700	3VL4860-3KE30-□□□□	1	1 unit	1CC	5.700
3VL6180-2KE30-□□□□	1	1 unit	1CC	15.700	3VL6180-3KE30-□□□□	1	1 unit	1CC	15.700
3VL7112-2KE30-□□□□	1	1 unit	1CC	23.500	3VL7112-3KE30-□□□□	1	1 unit	1CC	23.500
3VL8116-2KE30-□□□□	1	1 unit	1CC	29.800	3VL8116-3KE30-□□□□	1	1 unit	1CC	29.800

Molded Case Circuit Breakers

3VL Molded Case Circuit Breakers up to 1600 A, according to UL 489

3-pole

2

Type	Rated current I_n	Current setting of the inverse-time delayed overload protection "L" I_r	Response time of the inverse-time delayed overload protection "L" t_r	Operating current of the instantaneous short-circuit protection "I" I_i	DT	Standard breaking capacity N, up to 35 kA at 480 V see "Overview".	(N)				
	A	A	s	A		Article No. www.siemens.com/ product?Article No.	Price per PU	PU (UNIT, SET, M)	PS*/ P. unit	PG	Weight per PU approx.
						Article No. supplement required, see page 2/236					kg

Fixed-mounted molded case circuit breakers,
 VL150 UL (DG frame) to VL1600 UL (PG frame),
 Electronic Trip Units (UL file: E10848, CCN¹⁾: DIVQ



NSE0_00691

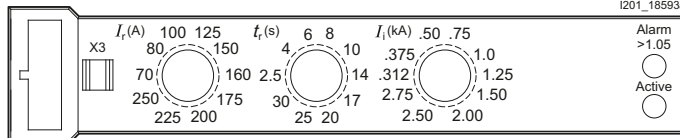

i201_18593a

Line protection

With Electronic Trip Units ETU (model 555)

LI function

Connection type:

Molded case circuit breakers without preassembled connections, connections must be ordered under "Accessories", "Plug-in versions/withdrawable versions", pages 2/251 to 2/254 or under "Accessories", "Connection parts for fixed-mounted molded case circuit breakers", pages 2/255 to 2/262.

VL150 UL, DG frame	60	30 ... 60	2.5 ... 30	75 ... 660 (11 x I_n)	3VL2506-1PB30-□□□□	1	1 unit	1CC	2.400
	100	40 ... 100	2.5 ... 30	125 ... 1100 (11 x I_n)	3VL2510-1PB30-□□□□	1	1 unit	1CC	2.400
	150	60 ... 150	2.5 ... 30	187 ... 1650 (11 x I_n)	3VL2515-1PB30-□□□□	1	1 unit	1CC	2.400
VL250 UL, FG frame	100	40 ... 100	2.5 ... 30	125 ... 1100 (11 x I_n)	3VL3510-1PB30-□□□□	1	1 unit	1CC	2.500
	150	60 ... 150	2.5 ... 30	187 ... 1650 (11 x I_n)	3VL3515-1PB30-□□□□	1	1 unit	1CC	2.500
	250	70 ... 250	2.5 ... 30	312 ... 2750 (11 x I_n)	3VL3525-1PB30-□□□□	1	1 unit	1CC	2.500
VL400 UL, JG frame	250	70 ... 250	2.5 ... 30	312 ... 2750 (11 x I_n)	3VL4125-1PB30-□□□□	1	1 unit	1CC	5.900
	400	150 ... 400	2.5 ... 30	500 ... 4400 (11 x I_n)	3VL4140-1PB30-□□□□	1	1 unit	1CC	5.900
VL400X UL, LG frame	400	150 ... 400	2.5 ... 30	500 ... 4400 (11 x I_n)	3VL4840-1PB30-□□□□	1	1 unit	1CC	5.900
	600	200 ... 600	2.5 ... 30	750 ... 6000 (10 x I_n)	3VL4860-1PB30-□□□□	1	1 unit	1CC	5.900
VL800 UL, MG frame	600	200 ... 600	2.5 ... 30	750 ... 6000 (10 x I_n)	3VL6160-1PB30-□□□□	1	1 unit	1CC	16.000
	800	300 ... 800	2.5 ... 30	1000 ... 6000 (7.5 x I_n)	3VL6180-1PB30-□□□□	1	1 unit	1CC	16.000
VL1200 UL, NG frame	800	300 ... 800	2.5 ... 30	1000 ... 8800 (11 x I_n)	3VL7180-1PB30-□□□□	1	1 unit	1CC	25.000
	1000	400 ... 1000	2.5 ... 30	1250 ... 11000 (11 x I_n)	3VL7110-1PB30-□□□□	1	1 unit	1CC	25.000
	1200	400 ... 1200	2.5 ... 30	1500 ... 12000 (10 x I_n)	3VL7112-1PB30-□□□□	1	1 unit	1CC	25.000
VL1600 UL, PG frame ²⁾	1200	400 ... 1200	2.5 ... 30	1500 ... 12000 (10 x I_n)	3VL8112-1PB30-□□□□	1	1 unit	1CC	31.300
	1600	700 ... 1600	2.5 ... 30	2000 ... 9600 (6 x I_n)	3VL8116-1PB30-□□□□	1	1 unit	1CC	31.300

L = overload

I = short-circuit protection, instantaneous

¹⁾ UL Category Code Number.

²⁾ Operation of the molded case circuit breaker within the scope of application of UL 489/CSA is permitted only in conjunction with the mounting base (see page 2/262).

Molded Case Circuit Breakers

3VL Molded Case Circuit Breakers up to 1600 A, according to UL 489

3-pole

2

DT	High breaking capacity H, up to 65 kA at 480 V					(H)	DT	Very high breaking capacity L, up to 100 kA at 480 V					(L)
	Article No. www.siemens.com/ product?Article No. Article No. supplement required, see page 2/236	Price per PU	PU (UNIT, SET, M)	PS*/ P. unit	PG	Weight per PU approx. kg		Article No. www.siemens.com/ product?Article No. Article No. supplement required, see page 2/236	Price per PU	PU (UNIT, SET, M)	PS*/ P. unit	PG	Weight per PU approx. kg

3VL2506-2PB30-□□□□	1	1 unit	1CC	2.400	3VL2506-3PB30-□□□□	1	1 unit	1CC	2.400
3VL2510-2PB30-□□□□	1	1 unit	1CC	2.400	3VL2510-3PB30-□□□□	1	1 unit	1CC	2.400
3VL2515-2PB30-□□□□	1	1 unit	1CC	2.400	3VL2515-3PB30-□□□□	1	1 unit	1CC	2.400
3VL3510-2PB30-□□□□	1	1 unit	1CC	2.500	3VL3510-3PB30-□□□□	1	1 unit	1CC	2.500
3VL3515-2PB30-□□□□	1	1 unit	1CC	2.500	3VL3515-3PB30-□□□□	1	1 unit	1CC	2.500
3VL3525-2PB30-□□□□	1	1 unit	1CC	2.500	3VL3525-3PB30-□□□□	1	1 unit	1CC	2.500
3VL4125-2PB30-□□□□	1	1 unit	1CC	5.900	3VL4125-3PB30-□□□□	1	1 unit	1CC	5.900
3VL4140-2PB30-□□□□	1	1 unit	1CC	5.900	3VL4140-3PB30-□□□□	1	1 unit	1CC	5.900
3VL4840-2PB30-□□□□	1	1 unit	1CC	5.900	3VL4840-3PB30-□□□□	1	1 unit	1CC	5.900
3VL4860-2PB30-□□□□	1	1 unit	1CC	5.900	3VL4860-3PB30-□□□□	1	1 unit	1CC	5.900
3VL6160-2PB30-□□□□	1	1 unit	1CC	16.000	3VL6160-3PB30-□□□□	1	1 unit	1CC	16.000
3VL6180-2PB30-□□□□	1	1 unit	1CC	16.000	3VL6180-3PB30-□□□□	1	1 unit	1CC	16.000
3VL7180-2PB30-□□□□	1	1 unit	1CC	25.000	3VL7180-3PB30-□□□□	1	1 unit	1CC	25.000
3VL7110-2PB30-□□□□	1	1 unit	1CC	25.000	3VL7110-3PB30-□□□□	1	1 unit	1CC	25.000
3VL7112-2PB30-□□□□	1	1 unit	1CC	25.000	3VL7112-3PB30-□□□□	1	1 unit	1CC	25.000
3VL8112-2PB30-□□□□	1	1 unit	1CC	31.300	3VL8112-3PB30-□□□□	1	1 unit	1CC	31.300
3VL8116-2PB30-□□□□	1	1 unit	1CC	31.300	3VL8116-3PB30-□□□□	1	1 unit	1CC	31.300

Molded Case Circuit Breakers

3VL Molded Case Circuit Breakers up to 1600 A, according to UL 489

3-pole

2

Type	Rated current I_n	Current setting of the inverse-time delayed overload protection "L" I_r	Re-sponse time of the inverse-time delayed overload protection "L" t_r	Operating current of the instantaneous short-circuit protection "I" I_i	Standard setting of I_g/A and t_g/s	t_g/s adjustable to 0.1, 0.2 and 0.3 s for the following I_g/A	DT	Standard breaking capacity N, up to 35 kA at 480 V ^(N)					
								Article No. www.siemens.com/product?ArticleNo .	Price per PU	PU (UNIT, SET, M)	PS*/P. unit	PG	Weight per PU approx.
	A	A	s	A				Article No. supplement required, see page 2/236					kg

Fixed-mounted molded case circuit breakers, VL150 UL (DG frame) to VL1600 UL (PG frame), Electronic Trip Units (UL file: E10848, CCN¹⁾: DIVQ

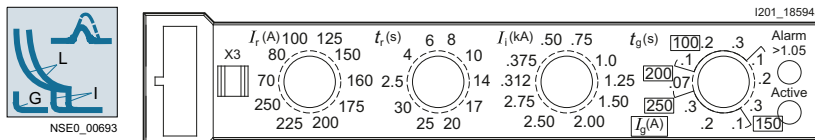

Line protection

With Electronic Trip Unit ETU (model 555)

LIG function

for 4-wire three-phase systems (vectorial summation current formation)

Connection type:

Molded case circuit breakers without preassembled connections,

connections must be ordered under "Accessories", "Plug-in versions/withdrawable versions", pages 2/251 to 2/254 or

under "Accessories", "Connection parts for fixed-mounted molded case circuit breakers", pages 2/255 to 2/262.

Current transformers must be ordered under "Accessories" page 2/270.

VL150	60	30 ... 60	2.5 ... 30	75 ... 660 (11 x I_n)	48/0.07	24/36/60	3VL2506-1PD30-□□□□	1	1 unit	1CC	2.400
UL, DG frame	100	40 ... 100	2.5 ... 30	125 ... 1100 (11 x I_n)	80/0.07	40/60/100	3VL2510-1PD30-□□□□	1	1 unit	1CC	2.400
	150	60 ... 150	2.5 ... 30	187 ... 1650 (11 x I_n)	120/0.07	60/90/150	3VL2515-1PD30-□□□□	1	1 unit	1CC	2.400
VL250	100	40 ... 100	2.5 ... 30	125 ... 1100 (11 x I_n)	80/0.07	40/60/100	3VL3510-1PD30-□□□□	1	1 unit	1CC	2.500
UL, FG frame	150	60 ... 150	2.5 ... 30	187 ... 1650 (11 x I_n)	120/0.07	60/90/150	3VL3515-1PD30-□□□□	1	1 unit	1CC	2.500
	250	70 ... 250	2.5 ... 30	312 ... 2750 (11 x I_n)	200/0.07	100/150/250	3VL3525-1PD30-□□□□	1	1 unit	1CC	2.500
VL400	250	70 ... 250	2.5 ... 30	312 ... 2750 (11 x I_n)	200/0.07	100/150/250	3VL4125-1PD30-□□□□	1	1 unit	1CC	5.900
UL, JG frame	400	150 ... 400	2.5 ... 30	500 ... 4400 (11 x I_n)	320/0.11	160/240/400	3VL4140-1PD30-□□□□	1	1 unit	1CC	5.900
VL400X	400	150 ... 400	2.5 ... 30	500 ... 4400 (11 x I_n)	320/0.11	160/240/400	3VL4840-1PD30-□□□□	1	1 unit	1CC	5.900
UL, LG frame	600	200 ... 600	2.5 ... 30	750 ... 6000 (10 x I_n)	360/0.18	240/360/600	3VL4860-1PD30-□□□□	1	1 unit	1CC	5.900
VL800	600	200 ... 600	2.5 ... 30	750 ... 6000 (10 x I_n)	360/0.18	240/360/600	3VL6160-1PD30-□□□□	1	1 unit	1CC	16.000
UL, MG frame	800	300 ... 800	2.5 ... 30	1000 ... 6000 (7.5 x I_n)	480/0.25	320/480/800	3VL6180-1PD30-□□□□	1	1 unit	1CC	16.000
VL1200	800	300 ... 800	2.5 ... 30	1000 ... 8800 (11 x I_n)	480/0.25	320/480/800	3VL7180-1PD30-□□□□	1	1 unit	1CC	25.000
UL, NG frame	1000	400 ... 1000	2.5 ... 30	1250 ... 11000 (11 x I_n)	600/0.32	400/600/1000	3VL7110-1PD30-□□□□	1	1 unit	1CC	25.000
	1200	400 ... 1200	2.5 ... 30	1500 ... 12000 (10 x I_n)	720/0.32	480/720/1200	3VL7112-1PD30-□□□□	1	1 unit	1CC	25.000
VL1600	1200	400 ... 1200	2.5 ... 30	1500 ... 12000 (10 x I_n)	720/0.32	480/720/1200	3VL8112-1PD30-□□□□	1	1 unit	1CC	31.300
UL, PG frame ²⁾	1600	700 ... 1600	2.5 ... 30	2000 ... 9600 (6 x I_n)	960/0.4	640/960/1200	3VL8116-1PD30-□□□□	1	1 unit	1CC	31.300

L = overload

I = short-circuit protection, instantaneous

G = ground-fault protection

¹⁾ UL Category Code Number.

²⁾ Operation of the molded case circuit breaker within the scope of application of UL 489/CSA is permitted only in conjunction with the mounting base (see page 2/262).

Molded Case Circuit Breakers

3VL Molded Case Circuit Breakers up to 1600 A, according to UL 489

3-pole

2

DT	High breaking capacity H, up to 65 kA at 480 V					(H)	DT	Very high breaking capacity L, up to 100 kA at 480 V					(L)
	Article No. www.siemens.com/ product?Article No.	Price per PU	PU (UNIT, SET, M)	PS*/ P. unit	PG	Weight per PU approx.		Article No. www.siemens.com/ product?Article No.	Price per PU	PU (UNIT, SET, M)	PS*/ P. unit	PG	Weight per PU approx.
	Article No. supplement required, see page 2/236					kg		Article No. supplement required, see page 2/236					kg

3VL2506-2PD30-□□□□	1	1 unit	1CC	2.400	3VL2506-3PD30-□□□□	1	1 unit	1CC	2.400
3VL2510-2PD30-□□□□	1	1 unit	1CC	2.400	3VL2510-3PD30-□□□□	1	1 unit	1CC	2.400
3VL2515-2PD30-□□□□	1	1 unit	1CC	2.400	3VL2515-3PD30-□□□□	1	1 unit	1CC	2.400
3VL3510-2PD30-□□□□	1	1 unit	1CC	2.500	3VL3510-3PD30-□□□□	1	1 unit	1CC	2.500
3VL3515-2PD30-□□□□	1	1 unit	1CC	2.500	3VL3515-3PD30-□□□□	1	1 unit	1CC	2.500
3VL3525-2PD30-□□□□	1	1 unit	1CC	2.500	3VL3525-3PD30-□□□□	1	1 unit	1CC	2.500
3VL4125-2PD30-□□□□	1	1 unit	1CC	5.900	3VL4125-3PD30-□□□□	1	1 unit	1CC	5.900
3VL4140-2PD30-□□□□	1	1 unit	1CC	5.900	3VL4140-3PD30-□□□□	1	1 unit	1CC	5.900
3VL4840-2PD30-□□□□	1	1 unit	1CC	5.900	3VL4840-3PD30-□□□□	1	1 unit	1CC	5.900
3VL4860-2PD30-□□□□	1	1 unit	1CC	5.900	3VL4860-3PD30-□□□□	1	1 unit	1CC	5.900
3VL6160-2PD30-□□□□	1	1 unit	1CC	16.000	3VL6160-3PD30-□□□□	1	1 unit	1CC	16.000
3VL6180-2PD30-□□□□	1	1 unit	1CC	16.000	3VL6180-3PD30-□□□□	1	1 unit	1CC	16.000
3VL7180-2PD30-□□□□	1	1 unit	1CC	25.000	3VL7180-3PD30-□□□□	1	1 unit	1CC	25.000
3VL7110-2PD30-□□□□	1	1 unit	1CC	25.000	3VL7110-3PD30-□□□□	1	1 unit	1CC	25.000
3VL7112-2PD30-□□□□	1	1 unit	1CC	25.000	3VL7112-3PD30-□□□□	1	1 unit	1CC	25.000
3VL8112-2PD30-□□□□	1	1 unit	1CC	31.300	3VL8112-3PD30-□□□□	1	1 unit	1CC	31.300
3VL8116-2PD30-□□□□	1	1 unit	1CC	31.300	3VL8116-3PD30-□□□□	1	1 unit	1CC	31.300

Molded Case Circuit Breakers

3VL Molded Case Circuit Breakers up to 1600 A, according to UL 489

3-pole

2

Type	Rated current I_n	Current setting of the inverse-time delayed overload protection "L" I_r	Response time of the inverse-time delayed overload protection "L" t_r	Operating current of the instantaneous short-circuit protection "I" I_i	Operating current of the short-time delayed short-circuit protection "S" I_{sd}	DT	Standard breaking capacity N, up to 35 kA at 480 V see "Overview".	Price per PU	PU (UNIT, SET, M)	PS*/P. unit	PG	Weight per PU approx.
	A	A	s	A	A		Article No. www.siemens.com/product?ArticleNo . Article No. supplement required, see page 2/236					kg

Fixed-mounted molded case circuit breakers, VL150 UL (DG frame) to VL1600 UL (PG frame), Electronic Trip Units (UL file: E10848, CCN¹⁾: DIVQ

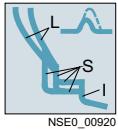

NSE0_00920

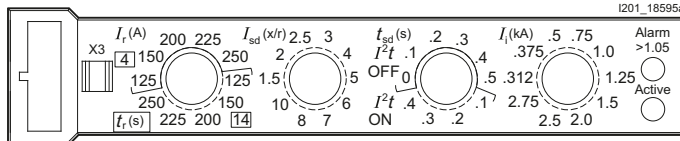

I201_18595a

Line and generator protection

With Electronic Trip Unit ETU (model 555)
 LSI function ($t_{sd} = 0$ to 0.5 s)

Connection type:

Molded case circuit breakers without preassembled connections, connections must be ordered under "Accessories", "Plug-in versions/withdrawable versions", pages 2/251 to 2/254 or under "Accessories", "Connection parts for fixed-mounted molded case circuit breakers", pages 2/255 to 2/262.

VL150 UL, DG frame	60 100 150	30 ... 60 40 ... 100 60 ... 150	4/14 4/14 4/14	75 ... 660 (11 x I_n) 125 ... 1100 (11 x I_n) 187 ... 1650 (11 x I_n)	1.5 ... 10 x I_r 1.5 ... 10 x I_r 1.5 ... 10 x I_r	3VL2506-1PE30-□□□□ 3VL2510-1PE30-□□□□ 3VL2515-1PE30-□□□□	1 1 1	1 unit 1 unit 1 unit	1CC 1CC 1CC	2.400 2.400 2.400
VL250 UL, FG frame	100 150 250	40 ... 100 60 ... 150 125 ... 250	4/14 4/14 4/14	125 ... 1100 (11 x I_n) 187 ... 1650 (11 x I_n) 312 ... 2750 (11 x I_n)	1.5 ... 10 x I_r 1.5 ... 10 x I_r 1.5 ... 10 x I_r	3VL3510-1PE30-□□□□ 3VL3515-1PE30-□□□□ 3VL3525-1PE30-□□□□	1 1 1	1 unit 1 unit 1 unit	1CC 1CC 1CC	2.500 2.500 2.500
VL400 UL, JG frame	250 400	125 ... 250 200 ... 400	4/14 10/20	312 ... 2750 (11 x I_n) 500 ... 4400 (11 x I_n)	1.5 ... 10 x I_r 1.5 ... 10 x I_r	3VL4125-1PE30-□□□□ 3VL4140-1PE30-□□□□	1 1	1 unit 1 unit	1CC 1CC	5.900 5.900
VL400X UL, LG frame	400 600	200 ... 400 350 ... 600	10/20 10/20	500 ... 4400 (11 x I_n) 750 ... 6000 (10 x I_n)	1.5 ... 10 x I_r 1.5 ... 10 x I_r	3VL4840-1PE30-□□□□ 3VL4860-1PE30-□□□□	1 1	1 unit 1 unit	1CC 1CC	5.900 5.900
VL800 UL, MG frame	600 800	350 ... 600 400 ... 800	10/20 10/20	750 ... 6000 (10 x I_n) 1000 ... 6000 (7.5 x I_n)	1.5 ... 10 x I_r 1.5 ... 10 x I_r	3VL6160-1PE30-□□□□ 3VL6180-1PE30-□□□□	1 1	1 unit 1 unit	1CC 1CC	16.000 16.000
VL1200 UL, NG frame	800 1000 1200	400 ... 800 600 ... 1000 700 ... 1200	10/20 10/20 10/20	1000 ... 8800 (11 x I_n) 1250 ... 11000 (11 x I_n) 1500 ... 12000 (10 x I_n)	1.5 ... 10 x I_r 1.5 ... 10 x I_r 1.5 ... 10 x I_r	3VL7180-1PE30-□□□□ 3VL7110-1PE30-□□□□ 3VL7112-1PE30-□□□□	1 1 1	1 unit 1 unit 1 unit	1CC 1CC 1CC	25.000 25.000 25.000
VL1600 UL, PG frame ²⁾	1200 1600	700 ... 1200 1000 ... 1600	10/20 10/20	1500 ... 12000 (10 x I_n) 2000 ... 9600 (6 x I_n)	1.5 ... 10 x I_r 1.5 ... 10 x I_r	3VL8112-1PE30-□□□□ 3VL8116-1PE30-□□□□	1 1	1 unit 1 unit	1CC 1CC	31.300 31.300

L = overload

S = short-circuit protection, short-time delayed

I = short-circuit protection, instantaneous

¹⁾ UL Category Code Number.

²⁾ Operation of the molded case circuit breaker within the scope of application of UL 489/CSA is permitted only in conjunction with the mounting base (see page 2/262).

Molded Case Circuit Breakers

3VL Molded Case Circuit Breakers up to 1600 A, according to UL 489

3-pole

2

DT	High breaking capacity H, up to 65 kA at 480 V					(H)	DT	Very high breaking capacity L, up to 100 kA at 480 V					(L)
	Article No. www.siemens.com/ product?Article No.	Price per PU	PU (UNIT, SET, M)	PS*/ P. unit	PG	Weight per PU approx.		Article No. www.siemens.com/ product?Article No.	Price per PU	PU (UNIT, SET, M)	PS*/ P. unit	PG	Weight per PU approx.
	Article No. supplement required, see page 2/236					kg		Article No. supplement required, see page 2/236					kg

3VL2506-2PE30-□□□□	1	1 unit	1CC	2.400	3VL2506-3PE30-□□□□	1	1 unit	1CC	2.400
3VL2510-2PE30-□□□□	1	1 unit	1CC	2.400	3VL2510-3PE30-□□□□	1	1 unit	1CC	2.400
3VL2515-2PE30-□□□□	1	1 unit	1CC	2.400	3VL2515-3PE30-□□□□	1	1 unit	1CC	2.400
3VL3510-2PE30-□□□□	1	1 unit	1CC	2.500	3VL3510-3PE30-□□□□	1	1 unit	1CC	2.500
3VL3515-2PE30-□□□□	1	1 unit	1CC	2.500	3VL3515-3PE30-□□□□	1	1 unit	1CC	2.500
3VL3525-2PE30-□□□□	1	1 unit	1CC	2.500	3VL3525-3PE30-□□□□	1	1 unit	1CC	2.500
3VL4125-2PE30-□□□□	1	1 unit	1CC	5.900	3VL4125-3PE30-□□□□	1	1 unit	1CC	5.900
3VL4140-2PE30-□□□□	1	1 unit	1CC	5.900	3VL4140-3PE30-□□□□	1	1 unit	1CC	5.900
3VL4840-2PE30-□□□□	1	1 unit	1CC	5.900	3VL4840-3PE30-□□□□	1	1 unit	1CC	5.900
3VL4860-2PE30-□□□□	1	1 unit	1CC	5.900	3VL4860-3PE30-□□□□	1	1 unit	1CC	5.900
3VL6160-2PE30-□□□□	1	1 unit	1CC	16.000	3VL6160-3PE30-□□□□	1	1 unit	1CC	16.000
3VL6180-2PE30-□□□□	1	1 unit	1CC	16.000	3VL6180-3PE30-□□□□	1	1 unit	1CC	16.000
3VL7180-2PE30-□□□□	1	1 unit	1CC	25.000	3VL7180-3PE30-□□□□	1	1 unit	1CC	25.000
3VL7110-2PE30-□□□□	1	1 unit	1CC	25.000	3VL7110-3PE30-□□□□	1	1 unit	1CC	25.000
3VL7112-2PE30-□□□□	1	1 unit	1CC	25.000	3VL7112-3PE30-□□□□	1	1 unit	1CC	25.000
3VL8112-2PE30-□□□□	1	1 unit	1CC	31.300	3VL8112-3PE30-□□□□	1	1 unit	1CC	31.300
3VL8116-2PE30-□□□□	1	1 unit	1CC	31.300	3VL8116-3PE30-□□□□	1	1 unit	1CC	31.300

Molded Case Circuit Breakers

3VL Molded Case Circuit Breakers up to 1600 A, according to UL 489

3-pole

2

Type	Rated current I_n	Current setting of the inverse-time delayed overload protection "L" I_r	Response time of the inverse-time delayed overload protection "L" t_r	Operating current of the instantaneous short-circuit protection "I" I_i	Operating current of the short-time delayed short-circuit protection "S" I_{sd}	Standard setting of I_g/A and t_g/s	t_g/s adjustable to 0.1, 0.2 and 0.3 s for the following I_g/A	DT	Standard breaking capacity N, up to 35 kA at 480 V see "Overview".	Price per PU	PU (UNIT, SET, M)	PS*/P. unit	PG	Weight per PU approx.
	A	A	s	A	A				Article No. www.siemens.com/product?ArticleNo . Article No. supplement required, see page 2/236					kg

Fixed-mounted molded case circuit breakers, VL150 UL (DG frame) to VL1600 UL (PG frame), Electronic Trip Units (UL file: E10848, CCN¹⁾: DIVQ

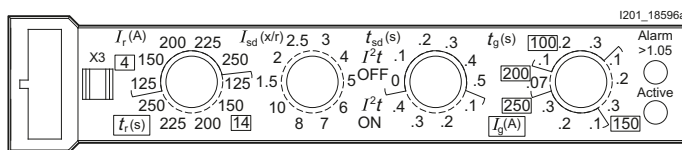
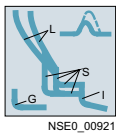

Line and generator protection

With Electronic Trip Unit ETU (model 555)
 LSIg function ($t_{sd} = 0$ to 0.5 s)
 for 4-wire three-phase systems (vectorial summation current formation)
 Connection type:

Molded case circuit breakers without preassembled connections, connections must be ordered under "Accessories", "Plug-in versions/withdrawable versions", pages 2/251 to 2/254 or under "Accessories", "Connection parts for fixed-mounted molded case circuit breakers", pages 2/255 to 2/262.
 Current transformers must be ordered under "Accessories" page 2/270.

VL150 UL, DG frame	60	30 ... 60	4/14	300/660 (5/11 x I_n)	1.5 ... 10 x I_r	48/0.07	24/36/60	3VL2506-1PH30-□□□□	1	1 unit	1CC	2.400
	100	40 ... 100	4/14	500/1100 (5/11 x I_n)	1.5 ... 10 x I_r	80/0.07	40/60/100	3VL2510-1PH30-□□□□	1	1 unit	1CC	2.400
	150	60 ... 150	4/14	750/1650 (5/11 x I_n)	1.5 ... 10 x I_r	120/0.07	60/90/150	3VL2515-1PH30-□□□□	1	1 unit	1CC	2.400
VL250 UL, FG frame	100	40 ... 100	4/14	500/1100 (5/11 x I_n)	1.5 ... 10 x I_r	80/0.07	40/60/100	3VL3510-1PH30-□□□□	1	1 unit	1CC	2.500
	150	60 ... 150	4/14	750/1650 (5/11 x I_n)	1.5 ... 10 x I_r	120/0.07	60/90/150	3VL3515-1PH30-□□□□	1	1 unit	1CC	2.500
	250	125 ... 250	4/14	1250/2750 (5/11 x I_n)	1.5 ... 10 x I_r	200/0.07	100/150/250	3VL3525-1PH30-□□□□	1	1 unit	1CC	2.500
VL400 UL, JG frame	250	125 ... 250	4/14	1250/2750 (5/11 x I_n)	1.5 ... 10 x I_r	200/0.07	100/150/250	3VL4125-1PH30-□□□□	1	1 unit	1CC	5.900
	400	200 ... 400	10/20	2000/4400 (5/11 x I_n)	1.5 ... 10 x I_r	320/0.11	160/240/400	3VL4140-1PH30-□□□□	1	1 unit	1CC	5.900
VL400X UL, LG frame	400	200 ... 400	10/20	2000/4400 (5/11 x I_n)	1.5 ... 10 x I_r	320/0.11	160/240/400	3VL4840-1PH30-□□□□	1	1 unit	1CC	5.900
	600	350 ... 600	10/20	3000/6000 (5/10 x I_n)	1.5 ... 10 x I_r	360/0.18	240/360/600	3VL4860-1PH30-□□□□	1	1 unit	1CC	5.900
VL800 UL, MG frame	600	350 ... 600	10/20	3000/6000 (5/10 x I_n)	1.5 ... 10 x I_r	360/0.18	240/360/600	3VL6160-1PH30-□□□□	1	1 unit	1CC	16.000
	800	400 ... 800	10/20	4000/6000 (5/7.5 x I_n)	1.5 ... 10 x I_r	480/0.25	320/480/800	3VL6180-1PH30-□□□□	1	1 unit	1CC	16.000
VL1200 UL, NG frame	800	400 ... 800	10/20	4000/8800 (5/11 x I_n)	1.5 ... 10 x I_r	480/0.25	320/480/800	3VL7180-1PH30-□□□□	1	1 unit	1CC	25.000
	1000	600 ... 1000	10/20	5000/11000 (5/11 x I_n)	1.5 ... 10 x I_r	600/0.32	400/600/1000	3VL7110-1PH30-□□□□	1	1 unit	1CC	25.000
	1200	700 ... 1200	10/20	6000/12000 (5/10 x I_n)	1.5 ... 10 x I_r	720/0.32	480/720/1200	3VL7112-1PH30-□□□□	1	1 unit	1CC	25.000
VL1600 UL, PG frame ²⁾	1200	700 ... 1200	10/20	6000/12000 (5/10 x I_n)	1.5 ... 10 x I_r	720/0.32	480/720/1200	3VL8112-1PH30-□□□□	1	1 unit	1CC	31.300
	1600	1000...1600	10/20	8000/9600 (5/6 x I_n)	1.5 ... 10 x I_r	960/0.4	640/960/1200	3VL8116-1PH30-□□□□	1	1 unit	1CC	31.300

L = overload

S = short-circuit protection, short-time delayed

I = short-circuit protection, instantaneous

G = ground-fault protection

¹⁾ UL Category Code Number.

²⁾ Operation of the molded case circuit breaker within the scope of application of UL 489/CSA is permitted only in conjunction with the mounting base (see page 2/262).

Molded Case Circuit Breakers

3VL Molded Case Circuit Breakers up to 1600 A, according to UL 489

3-pole

2

DT	High breaking capacity H, up to 65 kA at 480 V					(H)	DT	Very high breaking capacity L, up to 100 kA at 480 V					(L)
	Article No. www.siemens.com/ product?Article No. Article No. supplement required, see page 2/236	Price per PU	PU (UNIT, SET, M)	PS*/ P. unit	PG	Weight per PU approx. kg		Article No. www.siemens.com/ product?Article No. Article No. supplement required, see page 2/236	Price per PU	PU (UNIT, SET, M)	PS*/ P. unit	PG	Weight per PU approx. kg

3VL2506-2PH30-□□□□	1	1 unit	1CC	2.400	3VL2506-3PH30-□□□□	1	1 unit	1CC	2.400
3VL2510-2PH30-□□□□	1	1 unit	1CC	2.400	3VL2510-3PH30-□□□□	1	1 unit	1CC	2.400
3VL2515-2PH30-□□□□	1	1 unit	1CC	2.400	3VL2515-3PH30-□□□□	1	1 unit	1CC	2.400
3VL3510-2PH30-□□□□	1	1 unit	1CC	2.500	3VL3510-3PH30-□□□□	1	1 unit	1CC	2.500
3VL3515-2PH30-□□□□	1	1 unit	1CC	2.500	3VL3515-3PH30-□□□□	1	1 unit	1CC	2.500
3VL3525-2PH30-□□□□	1	1 unit	1CC	2.500	3VL3525-3PH30-□□□□	1	1 unit	1CC	2.500
3VL4125-2PH30-□□□□	1	1 unit	1CC	5.900	3VL4125-3PH30-□□□□	1	1 unit	1CC	5.900
3VL4140-2PH30-□□□□	1	1 unit	1CC	5.900	3VL4140-3PH30-□□□□	1	1 unit	1CC	5.900
3VL4840-2PH30-□□□□	1	1 unit	1CC	5.900	3VL4840-3PH30-□□□□	1	1 unit	1CC	5.900
3VL4860-2PH30-□□□□	1	1 unit	1CC	5.900	3VL4860-3PH30-□□□□	1	1 unit	1CC	5.900
3VL6160-2PH30-□□□□	1	1 unit	1CC	16.000	3VL6160-3PH30-□□□□	1	1 unit	1CC	16.000
3VL6180-2PH30-□□□□	1	1 unit	1CC	16.000	3VL6180-3PH30-□□□□	1	1 unit	1CC	16.000
3VL7180-2PH30-□□□□	1	1 unit	1CC	25.000	3VL7180-3PH30-□□□□	1	1 unit	1CC	25.000
3VL7110-2PH30-□□□□	1	1 unit	1CC	25.000	3VL7110-3PH30-□□□□	1	1 unit	1CC	25.000
3VL7112-2PH30-□□□□	1	1 unit	1CC	25.000	3VL7112-3PH30-□□□□	1	1 unit	1CC	25.000
3VL8112-2PH30-□□□□	1	1 unit	1CC	31.300	3VL8112-3PH30-□□□□	1	1 unit	1CC	31.300
3VL8116-2PH30-□□□□	1	1 unit	1CC	31.300	3VL8116-3PH30-□□□□	1	1 unit	1CC	31.300

Molded Case Circuit Breakers

3VL Molded Case Circuit Breakers up to 1600 A, according to UL 489

3-pole

2

Type	Rated current I_n	Current setting of the inverse-time delayed overload protection "L" I_r	Operating current of the instantaneous short-circuit protection "I" I_i	DT	Standard breaking capacity N, up to 35 kA at 480 V see "Overview".				(N)	
	A	A	A		Article No. www.siemens.com/ product?Article No.	Price per PU	PU (UNIT, SET, M)	PS* P. unit	PG	Weight per PU approx.
					Article No. supplement required, see page 2/236					kg

Fixed-mounted molded case circuit breakers, VL150 UL (DG frame) to VL1600 UL (PG frame), up to 1600 A, Electronic Trip Units (UL file: E10848, CCN¹): DIVQ

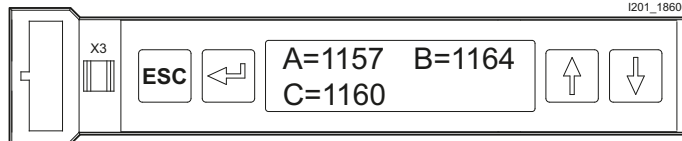
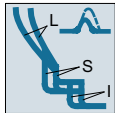

Molded case circuit breakers with Electronic Trip Unit with LCD, line protection with L/LS/LSI function

- Connection type:
Molded case circuit breakers without preassembled connections, connections must be ordered under "Accessories", "Plug-in versions/withdrawable versions", pages 2/251 to 2/254 or under "Accessories", "Connection parts for fixed-mounted molded case circuit breakers", pages 2/255 to 2/262.
- $t_{sd} = 0$ to 0.5 s
- t_r/s : 2.5, 4, 6, 8, 10, 14, 17, 20, 25, 30
- I_{sd}/A : 1.25 to $10 \times I_r^{(2)}$
- Pre-alarm % of I_r : 80 to 100

VL150 UL, DG frame	60 100 150	30 ... 60 40 ... 100 60 ... 150	75 ... 660 ($11 \times I_n$) 125 ... 1100 ($11 \times I_n$) 187 ... 1650 ($11 \times I_n$)	3VL2506-1VH30-□□□□ 3VL2510-1VH30-□□□□ 3VL2515-1VH30-□□□□	1 1 1	1 unit 1 unit 1 unit	1CC 1CC 1CC	2.400 2.400 2.400
VL250 UL, FG frame	100 150 250	40 ... 100 60 ... 150 70 ... 250	125 ... 1100 ($11 \times I_n$) 187 ... 1650 ($11 \times I_n$) 312 ... 2750 ($11 \times I_n$)	3VL3510-1VH30-□□□□ 3VL3515-1VH30-□□□□ 3VL3525-1VH30-□□□□	1 1 1	1 unit 1 unit 1 unit	1CC 1CC 1CC	2.500 2.500 2.500
VL400 UL, JG frame	250 400	70 ... 250 150 ... 400	312 ... 2750 ($11 \times I_n$) 500 ... 4400 ($11 \times I_n$)	3VL4125-1VH30-□□□□ 3VL4140-1VH30-□□□□	1 1	1 unit 1 unit	1CC 1CC	5.900 5.900
VL400X UL, LG frame	400 600	150 ... 400 200 ... 600	500 ... 4400 ($11 \times I_n$) 750 ... 6000 ($10 \times I_n$)	3VL4840-1VH30-□□□□ 3VL4860-1VH30-□□□□	1 1	1 unit 1 unit	1CC 1CC	5.900 5.900
VL800 UL, MG frame	600 800	200 ... 600 300 ... 800	750 ... 6000 ($10 \times I_n$) 1000 ... 6000 ($7.5 \times I_n$)	3VL6160-1VH30-□□□□ 3VL6180-1VH30-□□□□	1 1	1 unit 1 unit	1CC 1CC	16.000 16.000
VL1200 UL, NG frame	800 1000 1200	300 ... 800 400 ... 1000 400 ... 1200	1000 ... 8800 ($11 \times I_n$) 1250 ... 11000 ($11 \times I_n$) 1500 ... 12000 ($10 \times I_n$)	3VL7180-1VH30-□□□□ 3VL7110-1VH30-□□□□ 3VL7112-1VH30-□□□□	1 1 1	1 unit 1 unit 1 unit	1CC 1CC 1CC	25.000 25.000 25.000
VL1600 UL, PG frame ³⁾	1200 1600	400 ... 1200 700 ... 1600	1500 ... 12000 ($10 \times I_n$) 2000 ... 9600 ($6 \times I_n$)	3VL8112-1VH30-□□□□ 3VL8116-1VH30-□□□□	1 1	1 unit 1 unit	1CC 1CC	31.300 31.300

L = overload

S = short-circuit protection, short-time delayed

I = short-circuit protection, instantaneous

¹⁾ UL Category Code Number.

²⁾ Only for sizes for which I_i (max) = $11 \times I_n$. Here the factor is 11. Otherwise the following applies:
 I_{sd} (max) = (factor-1) $\times I_r$ (max). The factor is the value in brackets in the column I_i .

³⁾ Operation of the molded case circuit breaker within the scope of application of UL 489/CSA is permitted only in conjunction with the mounting base (see page 2/262).

Molded Case Circuit Breakers

3VL Molded Case Circuit Breakers up to 1600 A, according to UL 489

3-pole

2

DT	High breaking capacity H, up to 65 kA at 480 V						(H)	DT	Very high breaking capacity L, up to 100 kA at 480 V						(L)
	Article No. www.siemens.com/ product?Article No.	Price per PU	PU (UNIT, SET, M)	PS*/ P. unit	PG	Weight per PU approx.			Article No. www.siemens.com/ product?Article No.	Price per PU	PU (UNIT, SET, M)	PS*/ P. unit	PG	Weight per PU approx.	
	Article No. supplement required, see page 2/236					kg			Article No. supplement required, see page 2/236					kg	

3VL2506-2VH30-□□□□	1	1 unit	1CC	2.400			3VL2506-3VH30-□□□□	1	1 unit	1CC	2.400			
3VL2510-2VH30-□□□□	1	1 unit	1CC	2.400			3VL2510-3VH30-□□□□	1	1 unit	1CC	2.400			
3VL2515-2VH30-□□□□	1	1 unit	1CC	2.400			3VL2515-3VH30-□□□□	1	1 unit	1CC	2.400			
3VL3510-2VH30-□□□□	1	1 unit	1CC	2.500			3VL3510-3VH30-□□□□	1	1 unit	1CC	2.500			
3VL3515-2VH30-□□□□	1	1 unit	1CC	2.500			3VL3515-3VH30-□□□□	1	1 unit	1CC	2.500			
3VL3525-2VH30-□□□□	1	1 unit	1CC	2.500			3VL3525-3VH30-□□□□	1	1 unit	1CC	2.500			
3VL4125-2VH30-□□□□	1	1 unit	1CC	5.900			3VL4125-3VH30-□□□□	1	1 unit	1CC	5.900			
3VL4140-2VH30-□□□□	1	1 unit	1CC	5.900			3VL4140-3VH30-□□□□	1	1 unit	1CC	5.900			
3VL4840-2VH30-□□□□	1	1 unit	1CC	5.900			3VL4840-3VH30-□□□□	1	1 unit	1CC	5.900			
3VL4860-2VH30-□□□□	1	1 unit	1CC	5.900			3VL4860-3VH30-□□□□	1	1 unit	1CC	5.900			
3VL6160-2VH30-□□□□	1	1 unit	1CC	16.000			3VL6160-3VH30-□□□□	1	1 unit	1CC	16.000			
3VL6180-2VH30-□□□□	1	1 unit	1CC	16.000			3VL6180-3VH30-□□□□	1	1 unit	1CC	16.000			
3VL7180-2VH30-□□□□	1	1 unit	1CC	25.000			3VL7180-3VH30-□□□□	1	1 unit	1CC	25.000			
3VL7110-2VH30-□□□□	1	1 unit	1CC	25.000			3VL7110-3VH30-□□□□	1	1 unit	1CC	25.000			
3VL7112-2VH30-□□□□	1	1 unit	1CC	25.000			3VL7112-3VH30-□□□□	1	1 unit	1CC	25.000			
3VL8112-2VH30-□□□□	1	1 unit	1CC	31.300			3VL8112-3VH30-□□□□	1	1 unit	1CC	31.300			
3VL8116-2VH30-□□□□	1	1 unit	1CC	31.300			3VL8116-3VH30-□□□□	1	1 unit	1CC	31.300			

Molded Case Circuit Breakers

3VL Molded Case Circuit Breakers up to 1600 A, according to UL 489

3-pole

2

Type	Rated current I_n	Current setting of the inverse-time delayed overload protection "L" I_r	Operating current of the instantaneous short-circuit protection "I" I_i	I_g in % of I_n DT	Standard breaking capacity N, up to 35 kA at 480 V see "Overview".					Weight per PU approx.
	A	A	A		Article No. www.siemens.com/product?ArticleNo . Article No. supplement required, see page 2/236	Price per PU	PU (UNIT, SET, M)	PS*/P. unit	PG	kg

Fixed-mounted molded case circuit breakers, VL150 UL (DG frame) to VL1600 UL (PG frame), up to 1600 A, Electronic Trip Units (UL file: E10848, CCN¹): DIVQ

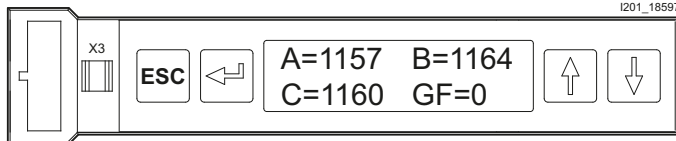
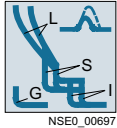

Molded case circuit breakers with Electronic Trip Unit with LCD, line protection with LSIG function or LSIG (alarm) function

- Connection type:
Molded case circuit breakers without preassembled connections, connections must be ordered under "Accessories", "Plug-in versions/withdrawable versions", pages 2/251 to 2/254 or under "Accessories", "Connection parts for fixed-mounted molded case circuit breakers", pages 2/255 to 2/262.
- t_f/s : 2.5, 4, 6, 8, 10, 14, 17, 20, 25, 30
- I_{sd}/A : 1.25 to 10 x $I_r^{(2)}$
- Pre-alarm % of I_r : 80 to 100
- t_g/s : 0.1; 0.2; 0.3; 0.4; 0.5

VL150 UL, DG frame	60 100 150	30 ... 60 40 ... 100 60 ... 150	75 ... 660 (11 x I_n) 125 ... 1100 (11 x I_n) 187 ... 1650 (11 x I_n)	40 ... 100 40 ... 100 40 ... 100	3VL2506-1□□30-□□□□ 3VL2510-1□□30-□□□□ 3VL2515-1□□30-□□□□	1 1 1	1 unit 1 unit 1 unit	1CC 1CC 1CC	2.400 2.400 2.400
VL250 UL, FG frame	100 150 250	40 ... 100 60 ... 150 70 ... 250	125 ... 1100 (11 x I_n) 187 ... 1650 (11 x I_n) 312 ... 2750 (11 x I_n)	40 ... 100 40 ... 100 40 ... 100	3VL3510-1□□30-□□□□ 3VL3515-1□□30-□□□□ 3VL3525-1□□30-□□□□	1 1 1	1 unit 1 unit 1 unit	1CC 1CC 1CC	2.500 2.500 2.500
VL400 UL, JG frame	250 400	70 ... 250 150 ... 400	312 ... 2750 (11 x I_n) 500 ... 4400 (11 x I_n)	40 ... 100 40 ... 100	3VL4125-1□□30-□□□□ 3VL4140-1□□30-□□□□	1 1	1 unit 1 unit	1CC 1CC	5.900 5.900
VL400X UL, LG frame	400 600	150 ... 400 200 ... 600	500 ... 4400 (11 x I_n) 750 ... 6000 (10 x I_n)	40 ... 100 40 ... 100	3VL4840-1□□30-□□□□ 3VL4860-1□□30-□□□□	1 1	1 unit 1 unit	1CC 1CC	5.900 5.900
VL800 UL, MG frame	600 800	200 ... 600 300 ... 800	750 ... 6000 (10 x I_n) 1000 ... 6000 (7.5 x I_n)	40 ... 100 40 ... 100	3VL6160-1□□30-□□□□ 3VL6180-1□□30-□□□□	1 1	1 unit 1 unit	1CC 1CC	16.000 16.000
VL1200 UL, NG frame	800 1000 1200	300 ... 800 400 ... 1000 400 ... 1200	1000 ... 8800 (11 x I_n) 1250 ... 11000 (11 x I_n) 1500 ... 12000 (10 x I_n)	40 ... 100 40 ... 100 40 ... 100	3VL7180-1□□30-□□□□ 3VL7110-1□□30-□□□□ 3VL7112-1□□30-□□□□	1 1 1	1 unit 1 unit 1 unit	1CC 1CC 1CC	25.000 25.000 25.000
VL1600 UL, PG frame ³⁾	1200 1600	400 ... 1200 700 ... 1600	1500 ... 12000 (10 x I_n) 2000 ... 9600 (6 x I_n)	40 ... 100 40 ... 75	3VL8112-1□□30-□□□□ 3VL8116-1□□30-□□□□	1 1	1 unit 1 unit	1CC 1CC	31.300 31.300

Electronic Trip Units with LCD, 3-pole version

Line protection with LSIG function

For 4-wire three-phase systems (vectorial summation current formation)
 $t_{sd} = 0$ to 0.5 s, $t_g = 0$ to 0.5 s

VM

Line protection with LSIG (alarm) function

For 4-wire three-phase systems (vectorial summation current formation)
 $t_{sd} = 0$ to 0.5 s, $t_g = 0$ to 0.5 s

VJ

- L = overload
- S = short-circuit protection, short-time delayed
- I = short-circuit protection, instantaneous
- G = ground-fault protection

- 1) UL Category Code Number.
- 2) Only for sizes for which I_i (max) = 11 x I_n . Here the factor is 11. Otherwise the following applies: I_{sd} (max) = (factor-1) x I_r (max). The factor is the value in brackets in the column I_i .
- 3) Operation of the molded case circuit breaker within the scope of application of UL 489/CSA is permitted only in conjunction with the mounting base (see page 2/262).

Molded Case Circuit Breakers

3VL Molded Case Circuit Breakers up to 1600 A, according to UL 489

3-pole

2

DT	High breaking capacity H, up to 65 kA at 480 V					(H)	DT	Very high breaking capacity L, up to 100 kA at 480 V					(L)
	Article No. www.siemens.com/ product?Article No.	Price per PU	PU (UNIT, SET, M)	PS*/ P. unit	PG	Weight per PU approx.		Article No. www.siemens.com/ product?Article No.	Price per PU	PU (UNIT, SET, M)	PS*/ P. unit	PG	Weight per PU approx.
	Article No. supplement required, see page 2/236					kg		Article No. supplement required, see page 2/236					kg

3VL2506-2□□30-□□□□	1	1 unit	1CC	2.400	3VL2506-3□□30-□□□□	1	1 unit	1CC	2.400
3VL2510-2□□30-□□□□	1	1 unit	1CC	2.400	3VL2510-3□□30-□□□□	1	1 unit	1CC	2.400
3VL2515-2□□30-□□□□	1	1 unit	1CC	2.400	3VL2515-3□□30-□□□□	1	1 unit	1CC	2.400
3VL3510-2□□30-□□□□	1	1 unit	1CC	2.500	3VL3510-3□□30-□□□□	1	1 unit	1CC	2.500
3VL3515-2□□30-□□□□	1	1 unit	1CC	2.500	3VL3515-3□□30-□□□□	1	1 unit	1CC	2.500
3VL3525-2□□30-□□□□	1	1 unit	1CC	2.500	3VL3525-3□□30-□□□□	1	1 unit	1CC	2.500
3VL4125-2□□30-□□□□	1	1 unit	1CC	5.900	3VL4125-3□□30-□□□□	1	1 unit	1CC	5.900
3VL4140-2□□30-□□□□	1	1 unit	1CC	5.900	3VL4140-3□□30-□□□□	1	1 unit	1CC	5.900
3VL4840-2□□30-□□□□	1	1 unit	1CC	5.900	3VL4840-3□□30-□□□□	1	1 unit	1CC	5.900
3VL4860-2□□30-□□□□	1	1 unit	1CC	5.900	3VL4860-3□□30-□□□□	1	1 unit	1CC	5.900
3VL6160-2□□30-□□□□	1	1 unit	1CC	16.000	3VL6160-3□□30-□□□□	1	1 unit	1CC	16.000
3VL6180-2□□30-□□□□	1	1 unit	1CC	16.000	3VL6180-3□□30-□□□□	1	1 unit	1CC	16.000
3VL7180-2□□30-□□□□	1	1 unit	1CC	25.000	3VL7180-3□□30-□□□□	1	1 unit	1CC	25.000
3VL7110-2□□30-□□□□	1	1 unit	1CC	25.000	3VL7110-3□□30-□□□□	1	1 unit	1CC	25.000
3VL7112-2□□30-□□□□	1	1 unit	1CC	25.000	3VL7112-3□□30-□□□□	1	1 unit	1CC	25.000
3VL8112-2□□30-□□□□	1	1 unit	1CC	31.300	3VL8112-3□□30-□□□□	1	1 unit	1CC	31.300
3VL8116-2□□30-□□□□	1	1 unit	1CC	31.300	3VL8116-3□□30-□□□□	1	1 unit	1CC	31.300

VM

VM

VJ

VJ

Molded Case Circuit Breakers

3VL Molded Case Circuit Breakers up to 1600 A, according to UL 489

Options

Selection and ordering data

1st Article No. supplement: Undervoltage release or shunt release, wiring directly to accessories

Rated control supply voltage U_s /frequency	Article No. supplement	Molded case circuit breakers	
50/60 Hz AC DC	3VL.....-.....- @ @ ..	Type	Type
		VL150X UL (CG frame) to VL400X UL (LG frame) ¹⁾	VL800 UL (MG frame) to VL1600 UL (PG frame)
		Additional price	Additional price
Without auxiliary release	0 A	None	None
With undervoltage release Only right pole			
V AC	V DC		
--	12	2 N ✓ ¹⁾	✓
--	24	2 P ✓ ¹⁾	✓
--	48	2 U ✓ ¹⁾	✓
--	60	2 V ✓ ¹⁾	✓
--	110-127	2 R ✓ ¹⁾	✓
--	220-250	2 S ✓ ¹⁾	✓
24	--	2 D ²⁾ ✓ ¹⁾	--
110-127	--	2 G ✓ ¹⁾	✓
220-250	--	2 H ✓ ¹⁾	✓
208	--	2 M ✓ ¹⁾	✓
277	--	2 Q ✓ ¹⁾	✓
380-415	--	2 J ✓ ¹⁾	✓
440-480	--	2 K ✓ ¹⁾	✓
500-525	--	2 L ²⁾ ✓ ¹⁾	--
With shunt release Only right pole			
V AC	V DC		
--	24	8 C ✓ ¹⁾	✓
--	48-60	8 J ✓ ¹⁾	✓
--	110-127	8 K ✓ ¹⁾	✓
--	220-250	8 Q ✓ ¹⁾	✓
48-60	--	8 M ✓ ¹⁾	✓
110-127	--	8 R ✓ ¹⁾	✓
208-277	--	8 T ✓ ¹⁾	✓
380-600	--	8 V ✓ ¹⁾	✓

2nd Article No. supplement: Auxiliary switches (HS) and alarm switches (AS), left/right pole, directly wired to accessories

Equipment	Article No. supplement	Molded case circuit breakers	
HS = 1 NO or 1 NC contact block AS = 1 NO contact block	3VL.....-.....- □ □	Type	Type
		VL150X UL (CG frame) to VL400X UL (LG frame)	VL800 UL (MG frame) to VL1600 UL (PG frame)
		Additional price	Additional price
Without auxiliary/alarm switches	A 0	None	None
2 HS (1 NO/1 NC) ³⁾	B 1	✓ ⁴⁾	--
4 HS (2 NO/2 NC)	C 1	--	✓
2 HS (1 NO/1 NC) + 1 AS (1 NO)	D 1	✓ ⁴⁾	--
2 HS (1 NO/1 NC) + 1 AS (1 NO) ⁵⁾	E 1	--	✓

✓ Additional price

-- Not available

- 1) Only an undervoltage release or a shunt release or an auxiliary/alarm switch combination is possible for VL150 UL (DG frame)/VL250 UL (FG frame) molded case circuit breakers with an Electronic Trip Unit.
- 2) Not for VL800 UL (MG frame), VL1200 UL (NG frame) and VL1600 UL (PG frame) molded case circuit breakers.
- 3) Up to 3 HS are possible with a mounting adapter.
- 4) Except for installation in the left accessory compartment of the VL150 UL (DG frame)/VL250 UL (FG frame) molded case circuit breakers with Electronic Trip Unit because this compartment is fitted with the tripping solenoid. Only an auxiliary release or an auxiliary/alarm switch combination can be installed on the right.
- 5) Up to 2 HS + 2 AS are possible with a mounting adapter.

When ordering, add "-Z" to the complete Article No. and add the relevant order code(s).

Article No. with "-Z"

Additional price

1 2 3 4 5 6 7 8 9 10 11 12 13 14 15 16

3VL -Z
and additional order code(s)

+ . . . + . . .

Code for further versions -Z

For fixed-mounted molded case circuit breakers (wired in factory)					
Wiring for internal accessories (auxiliary switches, alarm switches, or auxiliary releases not included in scope of supply) with connecting cables (3 m long) brought out at the rear	VL150X UL (CG frame) to VL1600 UL (PG frame)	L	0	2	✓
Wiring for motorized operating mechanisms (Motorized operating mechanism not included in scope of supply, for selection and ordering data, see pages 2/242 to 2/250) with connecting cables (3 m long) or brought out at the top in the case of VL150X UL (CG frame) to VL400X UL (LG frame) or brought out at the right in the case of VL800 UL (MG frame) to VL1600 UL (PG frame)	VL150X UL (CG frame) to VL1600 UL (PG frame)	L	1	2	✓
Motorized operating mechanism (24 V DC) Mounted on molded case circuit breaker (motorized operating mechanism included in the scope of supply) with wiring for internal accessories of the molded case circuit breaker with connecting cables (3 m long) brought out at the rear (auxiliary switches, alarm switches, or auxiliary releases not included in scope of supply)	VL150X UL (CG frame) to VL250 UL (FG frame)	M	2	4	✓
	VL400 UL (JG frame) to VL400X UL (LG frame)				✓
	VL800 UL (MG frame)				✓
	VL1200 UL (NG frame) to VL1600 UL (PG frame)				✓
Motorized operating mechanism (42-48 V AC/DC) Mounted on molded case circuit breaker (motorized operating mechanism included in the scope of supply) with wiring for internal accessories of the molded case circuit breaker with connecting cables (3 m long) brought out at the rear (auxiliary switches, alarm switches, or auxiliary releases not included in scope of supply)	VL150X UL (CG frame) to VL250 UL (FG frame)	M	4	2	✓
	VL400 UL (JG frame) to VL400X UL (LG frame)				✓
	VL800 UL (MG frame)				✓
	VL1200 UL (NG frame) to VL1600 UL (PG frame)				✓
Motorized operating mechanisms (60 V AC/DC) Mounted on molded case circuit breaker (motorized operating mechanism included in the scope of supply) with wiring for internal accessories of the molded case circuit breaker with connecting cables (3 m long) brought out at the rear (auxiliary switches, alarm switches, or auxiliary releases not included in scope of supply)	VL150X UL (CG frame) to VL250 UL (FG frame)	M	6	0	✓
	VL400 UL (JG frame) to VL400X UL (LG frame)				✓
	VL800 UL (MG frame)				✓
	VL1200 UL (NG frame) to VL1600 UL (PG frame)				✓
Motorized operating mechanism (110-127 V AC/DC) Mounted on molded case circuit breaker (motorized operating mechanism included in the scope of supply) with wiring for internal accessories of the molded case circuit breaker with connecting cables (3 m long) brought out at the rear (auxiliary switches, alarm switches, or auxiliary releases not included in scope of supply)	VL150X UL (CG frame) to VL250 UL (FG frame)	M	1	1	✓
	VL400 UL (JG frame) to VL400X UL (LG frame)				✓
	VL800 UL (MG frame)				✓
	VL1200 UL (NG frame) to VL1600 UL (PG frame)				✓
Motorized operating mechanism (220-250 V AC/DC) Mounted on molded case circuit breaker (motorized operating mechanism included in the scope of supply) with wiring for internal accessories of the molded case circuit breaker with connecting cables (3 m long) brought out at the rear (auxiliary switches, alarm switches, or auxiliary releases not included in scope of supply)	VL150X UL (CG frame) to VL250 UL (FG frame)	M	2	2	✓
	VL400 UL (JG frame) to VL400X UL (LG frame)				✓
	VL800 UL (MG frame)				✓
	VL1200 UL (NG frame) to VL1600 UL (PG frame)				✓

✓ Additional price

Molded Case Circuit Breakers

3VL Molded Case Circuit Breakers up to 1600 A, according to UL 489

Accessories and spare parts

Selection and ordering data

2

Wiring directly to accessories	DT	For VL150X UL (CG frame) to VL400X UL (LG frame)	PU (UNIT, SET, M)	PS*/P. unit	PG	Weight per PU approx.
		Article No. www.siemens.com/product?ArticleNo	Price per PU			kg

Auxiliary switches and auxiliary releases (UL file: E69455)

3-pole

Auxiliary switches (HS) and alarm switches (AS)
 For retrofitting

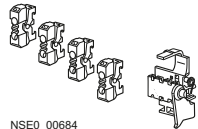

NSE0_00684
 3VL9400-2A.01

Assembly kits	Mounting side					
2 HS (1 NO + 1 NC)	N, left ¹⁾ , right	3VL9400-2AB01	1	1 unit	1CC	0.054
4 HS (2 NO + 2 NC)	N, left, right	--				
2 HS (1 NC + 1 NO) + 1 AS (1 NO) (assembly kit)	Left, right ²⁾ Left	3VL9400-2AD01	1	1 unit	1CC	0.081

Additional auxiliary switch/alarm switch combinations

See page 2/240.

Shunt releases

For retrofitting

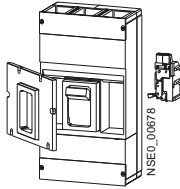

3VL9400-1S.01,
 3VL9400 1U.01

V AC	V DC	Mounting side				
--	24	Right pole only	3VL9400-1SC01	1	1 unit	1CC 0.101
--	48 ... 60	Right pole only	3VL9400-1SJ01	1	1 unit	1CC 0.103
--	110 ... 127	Right pole only	3VL9400-1SK01	1	1 unit	1CC 0.101
--	220 ... 250	Right pole only	3VL9400-1SQ01	1	1 unit	1CC 0.099
48 ... 60	--	Right pole only	3VL9400-1SM01	1	1 unit	1CC 0.103
110 ... 127	--	Right pole only	3VL9400-1SR01	1	1 unit	1CC 0.100
208 ... 277	--	Right pole only	3VL9400-1ST01	1	1 unit	1CC 0.102
380 ... 600	--	Right pole only	3VL9400-1SV01	1	1 unit	1CC 0.110

Undervoltage releases

For retrofitting

V AC	V DC	Mounting side				
--	12	Right pole only	3VL9400-1UN01	1	1 unit	1CC 0.092
--	24	Right pole only	3VL9400-1UP01	1	1 unit	1CC 0.096
--	48	Right pole only	3VL9400-1UU01	1	1 unit	1CC 0.097
--	60	Right pole only	3VL9400-1UV01	1	1 unit	1CC 0.098
24	--	Right pole only	3VL9400-1UD01	1	1 unit	1CC 0.100
110 ... 127	--	Right pole only	3VL9400-1UG01	1	1 unit	1CC 0.099
--	110 ... 127	Right pole only	3VL9400-1UR01	1	1 unit	1CC 0.099
208	--	Right pole only	3VL9400-1UM01	1	1 unit	1CC 0.101
220 ... 250	--	Right pole only	3VL9400-1UH01	1	1 unit	1CC 0.099
--	220 ... 250	Right pole only	3VL9400-1US01	1	1 unit	1CC 0.092
277	--	Right pole only	3VL9400-1UQ01	1	1 unit	1CC 0.094
380 ... 415	--	Right pole only	3VL9400-1UJ01	1	1 unit	1CC 0.096
440 ... 480	--	Right pole only	3VL9400-1UK01	1	1 unit	1CC 0.099
500 ... 525	--	Right pole only	3VL9400-1UL01	1	1 unit	1CC 0.100

¹⁾ Except for installation in the left accessory compartment of the VL150 UL (DG frame)/VL250 UL (FG frame) molded case circuit breakers with Electronic Trip Unit because this compartment is fitted with the tripping solenoid.

²⁾ In the case of VL400 UL (JG frame)/VL400X UL (LG frame): Unsuitable for mounting in the right-hand accessory compartment. The 3VL9400-2AB01 assembly kit with auxiliary switches only is recommended.

Wiring directly to accessories	DT	For VL800 UL (MG frame) to VL1600 UL (PG frame)	PU (UNIT, SET, M)	PS*/P. unit	PG	Weight per PU approx.
		Article No. www.siemens.com/product?Article No.	Price per PU			kg

Auxiliary switches and auxiliary releases
(UL file: E69455)

3-pole
Auxiliary switches (HS) and alarm switches (AS)
 For retrofitting

Assembly kits	Mounting side					
2 HS (1 NO + 1 NC)	N, left, right	--				
4 HS (2 NO + 2 NC)	N, left, right	3VL9800-2AC01	1	1 unit	1CC	0.086
2 HS (1 NC + 1 NO) + 1 AS (1 NO) (assembly kit)	Left, right Left	3VL9800-2AE01	1	1 unit	1CC	0.082

Additional auxiliary switch/alarm switch combinations see page 2/240.

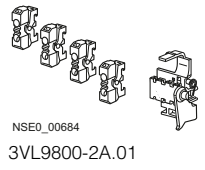

Shunt releases
 For retrofitting

V AC	V DC	Mounting side				
--	24	Right pole only	3VL9800-1SC01	1	1 unit	1CC 0.151
--	48 ... 60	Right pole only	3VL9800-1SJ01	1	1 unit	1CC 0.150
--	110 ... 127	Right pole only	3VL9800-1SK01	1	1 unit	1CC 0.152
--	220 ... 250	Right pole only	3VL9800-1SQ01	1	1 unit	1CC 0.150
48 ... 60	--	Right pole only	3VL9800-1SM01	1	1 unit	1CC 0.144
110 ... 127	--	Right pole only	3VL9800-1SR01	1	1 unit	1CC 0.153
208 ... 277	--	Right pole only	3VL9800-1ST01	1	1 unit	1CC 0.148
380 ... 600	--	Right pole only	3VL9800-1SV01	1	1 unit	1CC 0.160

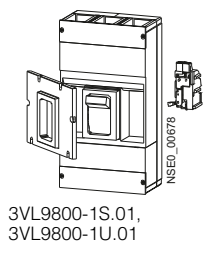

Undervoltage releases
 For retrofitting

V AC	V DC	Mounting side				
--	12	Right pole only	3VL9800-1UN01	1	1 unit	1CC 0.116
--	24	Right pole only	3VL9800-1UP01	1	1 unit	1CC 0.115
--	48	Right pole only	3VL9800-1UU01	1	1 unit	1CC 0.111
--	60	Right pole only	3VL9800-1UV01	1	1 unit	1CC 0.115
110 ... 127	--	Right pole only	3VL9800-1UG01	1	1 unit	1CC 0.111
--	110 ... 127	Right pole only	3VL9800-1UR01	1	1 unit	1CC 0.112
208	--	Right pole only	3VL9800-1UM01	1	1 unit	1CC 0.115
220 ... 250	--	Right pole only	3VL9800-1UH01	1	1 unit	1CC 0.114
--	220 ... 250	Right pole only	3VL9800-1US01	1	1 unit	1CC 0.112
277	--	Right pole only	3VL9800-1UQ01	1	1 unit	1CC 0.135
380 ... 415	--	Right pole only	3VL9800-1UJ01	1	1 unit	1CC 0.131
440 ... 480	--	Right pole only	3VL9800-1UK01	1	1 unit	1CC 0.137
500 ... 525	--	Right pole only	--			

* You can order this quantity or a multiple thereof.

Molded Case Circuit Breakers

3VL Molded Case Circuit Breakers up to 1600 A, according to UL 489

Accessories and spare parts

2

For molded case circuit breakers	Maximum combination of auxiliary switches (HS) and alarm switches (AS)	DT	Article No. www.siemens.com/product?ArticleNo.	Price per PU	PU (UNIT, SET, M)	PS*/P. unit	PG	Weight per PU approx. kg
----------------------------------	--	----	---	--------------	-------------------	-------------	----	-----------------------------

Type

3SB adapters and 3SB contact blocks

Mounting adapters for auxiliary and alarm switch combinations (UL file: E69455)

For installation in the left pole of the molded case circuit breaker

VL150X UL (CG frame), VL150 UL (DG frame), VL250 UL (FG frame), VL400 UL (JG frame), VL400X UL (LG frame)	Up to 3 HS ¹⁾		3VL9400-2AH01		1	1 unit	1CC	0.037
	2 HS + 1 AS ^{1) 2)}		3VL9400-2AJ11		1	1 unit	1CC	0.037
VL800 UL (MG frame), VL1200 UL (NG frame), VL1600 UL (PG frame)	Up to 4 HS		3VL9816-2AL01		1	1 unit	1CC	0.050
	2 HS + 2 AS		3VL9816-2AN11		1	1 unit	1CC	0.060

For installation in the right pole of the molded case circuit breaker

VL150X UL (CG frame), VL150 UL (DG frame), VL250 UL (FG frame), VL400 UL (JG frame), VL400X UL (LG frame) ²⁾	Up to 3 HS ¹⁾		3VL9400-2AH01		1	1 unit	1CC	0.037
	2 HS + 1 AS ^{1) 2)}		3VL9400-2AJ21		1	1 unit	1CC	0.033
VL800 UL (MG frame), VL1200 UL (NG frame), VL1600 UL (PG frame)	Up to 4 HS		3VL9816-2AL01		1	1 unit	1CC	0.050
	2 HS + 2 AS		--					

¹⁾ Except for installation in the left pole for VL150 UL (DG frame)/VL250 UL (FG frame) molded case circuit breakers with Electronic Trip Unit. Only an auxiliary release or an auxiliary/alarm switch combination can be installed on the right.

²⁾ In the case of VL400 UL (JG frame)/VL400X UL (LG frame): 3VL9400-2AJ21 unsuitable for mounting in the right-hand accessory compartment.

For auxiliary switches (HS) and alarm switches (AS)	DT	Molded case circuit breakers Type VL150X UL (CG frame) to VL1600 UL (PG frame)	PU (UNIT, SET, M)	PS*/ P. unit	PG	Weight per PU approx. kg
		Article No. www.siemens.com/ product?Article No.				Price per PU
Contact blocks for auxiliary switch (HS) and alarm switch (AS) combinations						
1 NO		3SB3400-0J	1	1 unit	41J	0.009
1 NC		3SB3400-0K	1	1 unit	41J	0.009

For auxiliary switch or alarm switch combinations not included in the kits provided as standard, the mounting adapters specified can be ordered separately together with the required contact blocks:

- 1 HS or 1 AS with NO contact 3SB3400-0J
- 1 HS or 1 AS with NC contact 3SB3400-0K

Notes:

A maximum of 6 contact blocks (HS) per molded case circuit breaker (VL150X UL (CG frame) to VL400X UL (LG frame)) and a maximum of 8 contact blocks (HS) per molded case circuit breaker (VL800 UL (MG frame) to VL1600 UL (PG frame)) are possible.

Four 3SB3 auxiliary contact blocks and one mounting adapter (right), suitable for VL800 UL (MG frame) to VL1600 UL (PG frame) molded case circuit breakers.

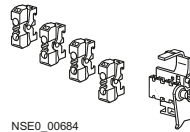

NSEO_00684

For retrofitting/equipment options, see chapter "Design", "Auxiliary releases and auxiliary switches".

Molded Case Circuit Breakers

3VL Molded Case Circuit Breakers up to 1600 A, according to UL 489

Accessories and spare parts

2

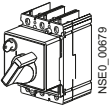
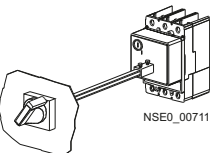
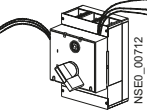
Version	DT	For VL150X UL (CG frame) to VL250 UL (FG frame)	PU (UNIT, SET, M)	PS*/P. unit	PG	Weight per PU approx.
		Article No. www.siemens.com/product?Article No.	Price per PU			kg
Operating mechanisms						
 3VL9.00-3H.01	3-pole Front-operated rotary operating mechanisms (UL file: E69455) For direct mounting on the molded case circuit breaker, without leading auxiliary switch, degree of protection IP30 ¹⁾ , black EMERGENCY-STOP version Red knob, yellow indicator plate Safety locks for installation by the customer, see pages 2/263 to 2/267 .		3VL9300-3HA01	1	1 unit	1CC 0.490
			3VL9300-3HC01	1	1 unit	1CC 0.470
 3VL9.00-3H.06	Door-coupling rotary operating mechanisms, complete; installation in doors and covers (UL file: E69455) NEMA 1, 12 Degree of protection IP65, including black knob with masking plate, indicator plate, removable door coupling, extension shaft 300 mm and front-operated rotary operating mechanism for the respective molded case circuit breaker EMERGENCY-STOP version Red knob, yellow indicator plate, without leading auxiliary switch Safety locks for installation by the customer, see pages 2/263 to 2/267 .		3VL9300-3HF06	1	1 unit	1CC 0.870
			3VL9300-3HG06	1	1 unit	1CC 0.828
Interlocking module UL 508A²⁾ For use with 3VL1, 3VL2, 3VL3, 3VL4, 3VL4X and 3RV19.6-2			8UC9400	1	1 unit	1CL 1.780
 3VL9.00-3A.11	Leading auxiliary switches for installation in a front-operated rotary operating mechanism or door-coupling rotary operating mechanism (UL file: E69455) Standard or EMERGENCY-STOP version "OFF after ON" Leading auxiliary switches when switching on 1 changeover contact with 1.5 m long cables 2 changeover contacts with 1.5 m long cables "ON after OFF" Leading auxiliary switches when switching off 1 changeover contact with 1.5 m long cables 2 changeover contacts with 1.5 m long cables		3VL9300-3AS11	1	1 unit	1CC 0.098
			3VL9300-3AT11	1	1 unit	1CC 0.170
			3VL9300-3AU11	1	1 unit	1CC 0.113
			3VL9300-3AW11	1	1 unit	1CC 0.173
Rotary operating mechanisms with shaft stub, without knob Without leading auxiliary switch, for auxiliary switches, see above .			3VL9300-3HE01	1	1 unit	1CC 0.445

¹⁾ IP40 with additional masking frame mounted on the door cutout.

²⁾ In combination with 3VL1 to VL5, the interlocking module can be used with the complete door-coupling rotary operating mechanisms as follows:

	3VL1/3VL2/3VL3	3VL4/3VL4X
Door-coupling rotary operating mechanisms, complete		
• Black knob, light-gray indicator plate	3VL9300-3HF06	3VL9400-3HF06
• Red knob, yellow indicator plate	3VL9300-3HG06	3VL9400-3HG06

Molded Case Circuit Breakers

3VL Molded Case Circuit Breakers up to 1600 A, according to UL 489

Accessories and spare parts

2

DT	For VL400 UL (JG frame) to VL400X UL (LG frame)	PU (UNIT, SET, M)	PS*/P. unit	PG	Weight per PU approx. kg	DT	For VL800 UL (MG frame)	PU (UNIT, SET, M)	PS*/P. unit	PG	Weight per PU approx. kg
	Article No. www.siemens.com/product?Article No. Price per PU						Article No. www.siemens.com/product?Article No. Price per PU				
	3VL9400-3HA01	1	1 unit	1CC	1.180		3VL9600-3HA01	1	1 unit	1CC	1.340
	3VL9400-3HC01	1	1 unit	1CC	1.129		3VL9600-3HC01	1	1 unit	1CC	1.376
	3VL9400-3HF06	1	1 unit	1CC	1.650		3VL9600-3HF06	1	1 unit	1CC	1.700
	3VL9400-3HG06	1	1 unit	1CC	1.597		3VL9600-3HG06	1	1 unit	1CC	1.800
	8UC9400	1	1 unit	1CL	1.780		--				
	3VL9400-3AS11	1	1 unit	1CC	0.088		3VL9600-3AS11	1	1 unit	1CC	0.091
	3VL9400-3AT11	1	1 unit	1CC	0.180		3VL9600-3AT11	1	1 unit	1CC	0.142
	3VL9400-3AU11	1	1 unit	1CC	0.100		3VL9600-3AU11	1	1 unit	1CC	0.090
	3VL9400-3AW11	1	1 unit	1CC	0.160		3VL9600-3AW11	1	1 unit	1CC	0.140
	3VL9400-3HE01	1	1 unit	1CC	1.100		3VL9600-3HE01	1	1 unit	1CC	1.282

Molded Case Circuit Breakers



3VL Molded Case Circuit Breakers up to 1600 A, according to UL 489

Accessories and spare parts

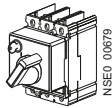
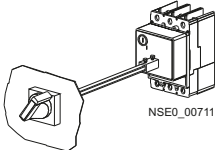
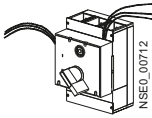
2

Version	DT	For VL1200 UL (NG frame) to VL1600 UL (PG frame)	PU (UNIT, SET, M)	PS* / P. unit	PG	Weight per PU approx.
		Article No. www.siemens.com/ product?Article No.	Price per PU			kg
Operating mechanisms						
3-pole						
Front-operated rotary operating mechanisms (UL file: E69455)						
 NSE0_00679 3VL9.00-3H.01	For direct mounting on the molded case circuit breaker, without leading auxiliary switch, degree of protection IP30 ¹⁾ , black EMERGENCY-STOP version Red knob, yellow indicator plate Safety locks for installation by the customer, see pages 2/263 to 2/267 .		3VL9800-3HA01	1	1 unit	1CC 3.550
			3VL9800-3HC01	1	1 unit	1CC 3.145
 NSE0_00711 3VL9.00-3H.06	Door-coupling rotary operating mechanisms, complete; installation in doors and covers (UL file: E69455) Degree of protection IP65, including black knob with masking plate, indicator plate, removable door coupling, extension shaft 300 mm and front-operated rotary operating mechanism for the respective molded case circuit breaker EMERGENCY-STOP version Red knob, yellow indicator plate, without leading auxiliary switch Safety locks for installation by the customer, see pages 2/263 to 2/267 .		3VL9800-3HF06	1	1 unit	1CC 4.538
			3VL9800-3HG06	1	1 unit	1CC 4.445
 NSE0_00712 3VL9.00-3A.11	Leading auxiliary switches for installation in a front-operated rotary operating mechanism or door-coupling rotary operating mechanism (UL file: E69455) Standard or EMERGENCY-STOP version "OFF after ON" Leading auxiliary switches when switching on 1 changeover contact with 1.5 m long cables 2 changeover contacts with 1.5 m long cables "ON after OFF" Leading auxiliary switches when switching off 1 changeover contact with 1.5 m long cables 2 changeover contacts with 1.5 m long cables		3VL9800-3AS21	1	1 unit	1CC 0.160
			3VL9800-3AT21	1	1 unit	1CC 0.178
			3VL9800-3AU11	1	1 unit	1CC 0.089
			3VL9800-3AW11	1	1 unit	1CC 0.140
		Rotary operating mechanisms with shaft stub, without knob Without leading auxiliary switch, for auxiliary switches, see above .	3VL9800-3HE01	1	1 unit	1CC 2.421

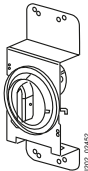
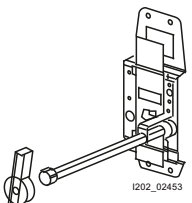
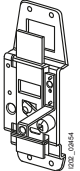
¹⁾ IP40 with additional masking frame mounted on the door cutout.

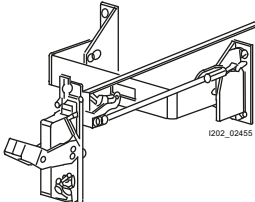
Version	DT	For VL150 UL (DG frame) to VL250 UL (FG frame)	PU (UNIT, SET, M)	PS*/P. unit	PG	Weight per PU approx.
		Article No. www.siemens.com/ product?Article No.	Price per PU			kg
Operating mechanisms						
		3-pole Front-operated rotary operating mechanisms Fixed depth; knob is fastened directly on molded case circuit breaker, silver knob, black lettering Lockable with up to 3 padlocks	3VL9300-3JA01	1	1 unit	1CC 0.980
		Door-coupling rotary operating mechanisms, complete Variable installation depth, knob for door fitting, including knob with masking plate Black knob Indicator plate, removable door coupling 12-inch extension shaft and front-operated rotary operating mechanism for the respective molded case circuit breaker Lockable knob (up to 3 padlocks), NEMA 1, 12	3VL9300-3JD01	1	1 unit	1CC 0.854
		Switching mechanism for door-coupling rotary operating mechanisms Switching mechanism	3VL9300-3JE01	1	1 unit	1CC 0.376
		Handle for door-coupling rotary operating mechanisms				
		Standard version				
		NEMA 1, 12	3VL9600-3JF11	1	1 unit	1CC 0.100
		NEMA 3R	3VL9600-3JF01	1	1 unit	1CC 0.100
		NEMA 4X	3VL9600-3JF41	1	1 unit	1CC 0.100
		EMERGENCY-STOP version	3VL9600-3JG01	1	1 unit	1CC 1.421
		• red knob • yellow indicator plate				
		Extension shaft for door-coupling rotary operating mechanisms				
		2 inch (50 mm)	3VL9600-3JJ01	1	1 unit	1CC 0.100
		3 inch (76 mm)	--			
		12 inch (0.3 m)	3VL9600-3JJ11	1	1 unit	1CC 0.100
		16 inch (0.4 m)	3VL9600-3JJ21	1	1 unit	1CC 0.100
		24 inch (0.6 m) with support bracket	3VL9600-3JJ41	1	1 unit	1CC 0.676
		NFPA-79 intermediate operating mechanism For door-coupling rotary operating mechanisms	3VL9300-3JF81	1	1 unit	1CC 0.260
		Operating mechanism with flange connection for variable installation depth Adjustable from 8 to 16 inch (approx. 200 to 400 mm) Complete kit, including knob Red/black knob ¹⁾				
		NEMA 1, 3R, 12 plastic	3VL9300-3JS01	1	1 unit	1CC 1.717
		NEMA 4, 4X chrome-plated steel	3VL9300-3JS41	1	1 unit	1CC 0.010
		Black knob ¹⁾				
		NEMA 1, 3R, 12 plastic	3VL9300-3JS11	1	1 unit	1CC 0.010
		NEMA 4, 4X chrome-plated steel	3VL9300-3JS51	1	1 unit	1CC 2.417



¹⁾ The knobs in monochrome gray or black are preferably used in IEC markets. Red/black knobs (red for ON) are standard in UL markets.

Molded Case Circuit Breakers

3VL Molded Case Circuit Breakers up to 1600 A, according to UL 489

Accessories and spare parts

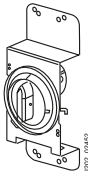
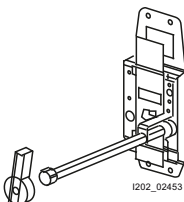
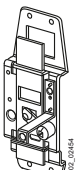
2

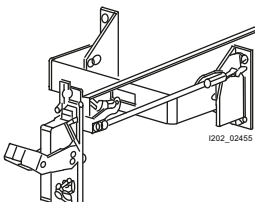
Version	DT	For VL400 UL (JG frame) to VL400X UL (LG frame)	PU (UNIT, SET, M)	PS* P. unit	PG	Weight per PU approx. kg	
		Article No. www.siemens.com/product?Article No. Price per PU					
Operating mechanisms							
 3VL9.00-3JA01		3-pole Front-operated rotary operating mechanisms Fixed depth; knob is fastened directly on molded case circuit breaker, silver knob, black lettering Lockable with up to 3 padlocks	3VL9400-3JA01	1	1 unit	1CC 0.100	
 3VL9.00-3JD01		Door-coupling rotary operating mechanisms, complete Variable installation depth, knob for door fitting, including knob with masking plate Black knob Indicator plate, removable door coupling 12-inch extension shaft and front-operated rotary operating mechanism for the respective molded case circuit breaker Lockable knob (up to 3 padlocks) NEMA 1, 12	3VL9400-3JD01	1	1 unit	1CC 0.100	
 3VL9800-3JE01		Switching mechanism for door-coupling rotary operating mechanisms Switching mechanism	3VL9400-3JE01	1	1 unit	1CC 0.100	
		Handle for door-coupling rotary operating mechanisms Standard version	NEMA 1, 12 NEMA 3R NEMA 4X	3VL9600-3JF11 3VL9600-3JF01 3VL9600-3JF41	1 1 1	1 unit 1 unit 1 unit	1CC 0.100 1CC 0.100 1CC 0.100
		EMERGENCY-STOP version • red knob • yellow indicator plate	NEMA 1, 12	3VL9600-3JG01	1	1 unit	1CC 1.421
		Extension shaft for door-coupling rotary operating mechanisms 2 inch (50 mm) 3 inch (76 mm) 12 inch (0.3 m) 16 inch (0.4 m) 24 inch (0.6 m) with support bracket		3VL9600-3JJ01 -- 3VL9600-3JJ11 3VL9600-3JJ21 3VL9600-3JJ41	1 1 1 1 1	1 unit 1 unit 1 unit 1 unit 1 unit	1CC 0.100 1CC 0.100 1CC 0.100 1CC 0.100 1CC 0.676
 3VL9800-3JF81		NFPA-79 intermediate operating mechanism For door-coupling rotary operating mechanisms	3VL9600-3JF81	1	1 unit	1CC 0.010	
 3VL9400-3JS01		Operating mechanism with flange connection for variable installation depth Adjustable from 8 to 16 inch (approx. 200 to 400 mm) Complete kit, including knob Red/black knob ¹⁾ NEMA 1, 3R, 12 plastic NEMA 4, 4X chrome-plated steel Black knob ¹⁾ NEMA 1, 3R, 12 plastic NEMA 4, 4X chrome-plated steel	3VL9400-3JS01 3VL9400-3JS41 3VL9400-3JS11 3VL9400-3JS51	1 1 1 1	1 unit 1 unit 1 unit 1 unit	1CC 0.010 1CC 0.010 1CC 0.010 2,353	

¹⁾ The knobs in monochrome gray or black are preferably used in IEC markets. Red/black knobs (red for ON) are standard in UL markets.

Molded Case Circuit Breakers

3VL Molded Case Circuit Breakers up to 1600 A, according to UL 489

Accessories and spare parts

2

DT For VL800 UL (MG frame)					DT For VL1200 UL (NG frame) to VL1600 UL (PG frame)						
Article No. www.siemens.com/ product?Article No.	Price per PU	PU (UNIT, SET, M)	PS*/ P. unit	PG	Weight per PU approx. kg	Article No. www.siemens.com/ product?Article No.	Price per PU	PU (UNIT, SET, M)	PS*/ P. unit	PG	Weight per PU approx. kg
--						--					
3VL9600-3JD01		1	1 unit	1CC	0.100	--					
3VL9600-3JE01		1	1 unit	1CC	0.100	3VL9800-3JE01		1	1 unit	1CC	0.100
3VL9600-3JF11		1	1 unit	1CC	0.100	3VL9800-3JF01		1	1 unit	1CC	0.100
3VL9600-3JF01		1	1 unit	1CC	0.100	3VL9800-3JF01		1	1 unit	1CC	0.100
3VL9600-3JF41		1	1 unit	1CC	0.100	3VL9800-3JF41		1	1 unit	1CC	0.100
3VL9600-3JG01		1	1 unit	1CC	1.421	--					
3VL9600-3JJ01		1	1 unit	1CC	0.100	--					
--						3VL9800-3JJ01		1	1 unit	1CC	0.100
3VL9600-3JJ11		1	1 unit	1CC	0.100	3VL9800-3JJ11		1	1 unit	1CC	0.100
3VL9600-3JJ21		1	1 unit	1CC	0.100	--					
3VL9600-3JJ41		1	1 unit	1CC	0.676	3VL9800-3JJ21		1	1 unit	1CC	0.100
3VL9600-3JF81		1	1 unit	1CC	0.010	3VL9800-3JF81		1	1 unit	1CC	0.010
--						--					
--						--					
--						--					
--						--					

Molded Case Circuit Breakers

3VL Molded Case Circuit Breakers up to 1600 A, according to UL 489

Accessories and spare parts

2

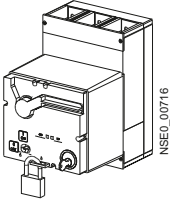
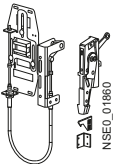
Version	DT	For VL150X UL (CG frame) to VL250 UL (FG frame)	PU (UNIT, SET, M)	PS*/P. unit	PG	Weight per PU approx.											
		Article No. www.siemens.com/product?Article No.	Price per PU			kg											
Operating mechanisms																	
 <p>3VL9.00-3M.01</p>	3-pole Motorized operating mechanism with spring energy store¹⁾ (UL file: E69455) Degree of protection IP30, with locking device for 3 padlocks, synchronizable																
	<table border="1"> <thead> <tr> <th>50/60 Hz V AC</th> <th>V DC</th> </tr> </thead> <tbody> <tr> <td>--</td> <td>24</td> </tr> <tr> <td>42 ... 48</td> <td>42 ... 48</td> </tr> <tr> <td>60</td> <td>60</td> </tr> <tr> <td>110 ... 127</td> <td>110 ... 127</td> </tr> <tr> <td>220 ... 250</td> <td>220 ... 250</td> </tr> </tbody> </table>	50/60 Hz V AC	V DC	--	24	42 ... 48	42 ... 48	60	60	110 ... 127	110 ... 127	220 ... 250	220 ... 250	<p>3VL9300-3MJ01</p> <p>3VL9300-3ML01</p> <p>3VL9300-3MS01</p> <p>3VL9300-3MN01</p> <p>3VL9300-3MQ01</p>	<p>1</p> <p>1</p> <p>1</p> <p>1</p> <p>1</p>	<p>1 unit</p> <p>1 unit</p> <p>1 unit</p> <p>1 unit</p> <p>1 unit</p>	<p>1CC</p> <p>1CC</p> <p>1CC</p> <p>1CC</p> <p>1CC</p>
50/60 Hz V AC	V DC																
--	24																
42 ... 48	42 ... 48																
60	60																
110 ... 127	110 ... 127																
220 ... 250	220 ... 250																
 <p>3VL9.00-3JM01</p>	Toggle lever extension --																
	Max Flex operating mechanism, complete including switching mechanism, Bowden wire, red/black knob, NEMA 1, 3R, 12 plastic Bowden wire, 36 inch (0.9 m) Bowden wire, 48 inch (1.2 m)		<p>3VL9300-3JM01</p> <p>--</p>	<p>1</p>	<p>1 unit</p>	<p>1CC</p>	<p>0.800</p>										
Knob for Max Flex operating mechanism Red/black knob ²⁾ NEMA 1, 3R, 12 plastic NEMA 1, 3R, 12 steel – epoxy sheathed NEMA 4, 4X chrome-plated steel Gray knob ²⁾ NEMA 1, 3R, 12 plastic Black knob ²⁾ NEMA 1, 3R, 12 steel – epoxy sheathed		<p>3VL9600-3JP01</p> <p>3VL9600-3JP21</p> <p>3VL9600-3JP41</p> <p>3VL9600-3JP11</p> <p>3VL9600-3JP61</p>	<p>1</p> <p>1</p> <p>1</p> <p>1</p> <p>1</p>	<p>1 unit</p> <p>1 unit</p> <p>1 unit</p> <p>1 unit</p> <p>1 unit</p>	<p>1CC</p> <p>1CC</p> <p>1CC</p> <p>1CC</p> <p>1CC</p>	<p>0.813</p> <p>0.811</p> <p>1.580</p> <p>0.100</p> <p>1.559</p>											
Switching mechanism for Max Flex operating mechanism		<p>3VL9300-3JN01</p>	<p>1</p>	<p>1 unit</p>	<p>1CC</p>	<p>4.536</p>											
Bowden wire for Max Flex operating mechanism 36 inch (0.9 m) 48 inch (1.2 m) 60 inch (1.5 m) 72 inch (1.8 m) 84 inch (2.1 m) 96 inch (2.4 m) 120 inch (3.0 m) 144 inch (3.6 m)		<p>3VL9300-3JQ31</p> <p>3VL9300-3JQ41</p> <p>3VL9300-3JQ61</p> <p>3VL9300-3JQ71</p> <p>3VL9300-3JQ81</p> <p>3VL9300-3JQ21</p> <p>3VL9300-3JQ01</p> <p>3VL9300-3JQ11</p>	<p>1</p> <p>1</p> <p>1</p> <p>1</p> <p>1</p> <p>1</p> <p>1</p> <p>1</p>	<p>1 unit</p> <p>1 unit</p> <p>1 unit</p> <p>1 unit</p> <p>1 unit</p> <p>1 unit</p> <p>1 unit</p> <p>1 unit</p>	<p>1CC</p> <p>1CC</p> <p>1CC</p> <p>1CC</p> <p>1CC</p> <p>1CC</p> <p>1CC</p>	<p>0.335</p> <p>0.383</p> <p>0.475</p> <p>0.505</p> <p>0.100</p> <p>0.584</p> <p>0.100</p> <p>0.729</p>											
Screw set For attaching the Max Flex operating mechanism incl. circuit breaker to an 8US busbar adapter (60 mm busbar system). • 1 set = 3 screws size M4 x 100 mm • 1 set = 2 screws size M6 x 100 mm and 2 special screws with threaded head		<p>3VL9300-8SE20</p> <p>--</p>	<p>1</p>	<p>1 unit</p>	<p>1CC</p>	<p>0.042</p>											
Leading auxiliary switch for Max Flex operating mechanism • 1 changeover contact with 1.5 m long cables • 2 changeover contacts with 1.5 m long cables		<p>3VL9300-2AP11</p> <p>3VL9300-2AP21</p>	<p>1</p> <p>1</p>	<p>1 unit</p> <p>1 unit</p>	<p>1CC</p> <p>1CC</p>	<p>0.090</p> <p>0.154</p>											

¹⁾ For safety lock as an assembly kit for retrofitting see pages 2/263 to 2/267.

²⁾ The knobs in monochrome gray or black are preferably used in IEC markets. Red/black knobs (red for ON) are standard in UL markets.

Molded Case Circuit Breakers

3VL Molded Case Circuit Breakers up to 1600 A, according to UL 489

Accessories and spare parts

2

DT	For VL400 UL (JG frame) to VL400X UL (LG frame)	PU (UNIT, SET, M)	PS*/ P. unit	PG	Weight per PU approx.	DT	For VL800 UL (MG frame)	PU (UNIT, SET, M)	PS*/ P. unit	PG	Weight per PU approx.
	Article No. www.siemens.com/product?Article No.				kg		Article No. www.siemens.com/product?Article No.				kg
	Price per PU						Price per PU				
	3VL9400-3MJ01	1	1 unit	1CC	4.550		3VL9600-3MJ01	1	1 unit	1CC	5.603
	3VL9400-3ML01	1	1 unit	1CC	4.594		3VL9600-3ML01	1	1 unit	1CC	5.510
	3VL9400-3MS01	1	1 unit	1CC	4.561		3VL9600-3MS01	1	1 unit	1CC	5.680
	3VL9400-3MN01	1	1 unit	1CC	4.651		3VL9600-3MN01	1	1 unit	1CC	5.656
	3VL9400-3MQ01	1	1 unit	1CC	4.592		3VL9600-3MQ01	1	1 unit	1CC	5.800
	3VL9400-3HN01	1	1 unit	1CC	0.024		3VL9600-3HN01	1	1 unit	1CC	0.026
	--						--				
	3VL9400-3JM01	1	1 unit	1CC	2.051		3VL9600-3JM01	1	1 unit	1CC	2.097
	3VL9600-3JP01	1	1 unit	1CC	0.813		3VL9600-3JP01	1	1 unit	1CC	0.813
	3VL9600-3JP21	1	1 unit	1CC	0.811		3VL9600-3JP21	1	1 unit	1CC	0.811
	3VL9600-3JP41	1	1 unit	1CC	1.580		3VL9600-3JP41	1	1 unit	1CC	1.580
	3VL9600-3JP11	1	1 unit	1CC	0.100		3VL9600-3JP11	1	1 unit	1CC	0.100
	3VL9600-3JP61	1	1 unit	1CC	1.559		3VL9600-3JP61	1	1 unit	1CC	1.559
	3VL9400-3JN01	1	1 unit	1CC	0.974		3VL9600-3JN01	1	1 unit	1CC	0.932
	3VL9600-3JQ31	1	1 unit	1CC	4.536		3VL9600-3JQ31	1	1 unit	1CC	4.536
	3VL9600-3JQ41	1	1 unit	1CC	0.370		3VL9600-3JQ41	1	1 unit	1CC	0.370
	3VL9600-3JQ61	1	1 unit	1CC	0.450		3VL9600-3JQ61	1	1 unit	1CC	0.450
	3VL9600-3JQ71	1	1 unit	1CC	0.518		3VL9600-3JQ71	1	1 unit	1CC	0.518
	3VL9600-3JQ81	1	1 unit	1CC	0.550		3VL9600-3JQ81	1	1 unit	1CC	0.550
	3VL9600-3JQ21	1	1 unit	1CC	0.100		3VL9600-3JQ21	1	1 unit	1CC	0.100
	3VL9600-3JQ01	1	1 unit	1CC	0.100		3VL9600-3JQ01	1	1 unit	1CC	0.100
	3VL9600-3JQ11	1	1 unit	1CC	0.100		3VL9600-3JQ11	1	1 unit	1CC	0.100
	--						--				
	3VL9460-8SE20	1	1 unit	1CC	0.123						
	3VL9400-2AP11	1	1 unit	1CC	0.075		3VL9800-2AP11	1	1 unit	1CC	0.010
	3VL9400-2AP21	1	1 unit	1CC	0.124		3VL9800-2AP21	1	1 unit	1CC	0.010

Molded Case Circuit Breakers

3VL Molded Case Circuit Breakers up to 1600 A, according to UL 489

Accessories and spare parts

2

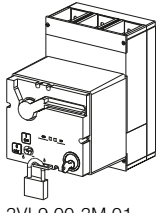
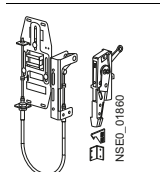
Version	DT	For VL1200 UL (NG frame) to VL1600 UL (PG frame)	PU (UNIT, SET, M)	PS*/P. unit	PG	Weight per PU approx.	
		Article No. www.siemens.com/product?Article No.	Price per PU			kg	
Operating mechanisms							
 <p>3VL9.00-3M.01</p>	3-pole Motorized operating mechanism¹⁾ (UL file: E69455) Degree of protection IP30, with locking device for 3 padlocks, not synchronizable						
	50/60 Hz V AC	V DC					
	--	24	3VL9800-3MJ01	1	1 unit	1CC	7.847
	42 ... 48	42 ... 48	3VL9800-3ML01	1	1 unit	1CC	7.900
	60	60	3VL9800-3MS01	1	1 unit	1CC	7.900
	110 ... 127	110 ... 127	3VL9800-3MN01	1	1 unit	1CC	7.797
220 ... 250	220 ... 250	3VL9800-3MQ01	1	1 unit	1CC	7.770	
		Toggle lever extension	3VL9800-3HN01	1	1 unit	1CC	0.241
 <p>3VL9.00-3JM01</p>	Max Flex operating mechanism, complete including switching mechanism, Bowden wire, red/black knob, NEMA 1, 3R, 12 steel – epoxy sheathed Bowden wire, 36 inch (0.9 m) Bowden wire, 48 inch (1.2 m)						
			3VL9800-3JM01	1	1 unit	1CC	4.340
	Knob for Max Flex operating mechanism Red/black knob ²⁾ NEMA 1, 3R, 12 plastic NEMA 1, 3R, 12 steel – epoxy sheathed NEMA 4, 4X chrome-plated steel Gray knob ²⁾ NEMA 1, 3R, 12 plastic Black knob ²⁾ NEMA 1, 3R, 12 steel – epoxy sheathed						
		3VL9800-3JP01	1	1 unit	1CC	0.100	
		3VL9800-3JP41	1	1 unit	1CC	0.100	
		3VL9800-3JP11	1	1 unit	1CC	0.100	
	Switching mechanism for Max Flex operating mechanism		3VL9800-3JN01	1	1 unit	1CC	0.100
	Bowden wire for Max Flex operating mechanism 36 inch (0.9 m) 48 inch (1.2 m) 60 inch (1.5 m) 72 inch (1.8 m) 84 inch (2.1 m) 96 inch (2.4 m) 120 inch (3.0 m) 144 inch (3.6 m)						
		3VL9800-3JQ41	1	1 unit	1CC	0.100	
		3VL9800-3JQ61	1	1 unit	1CC	0.100	
		3VL9800-3JQ71	1	1 unit	1CC	0.100	
		3VL9800-3JQ81	1	1 unit	1CC	0.100	
		3VL9800-3JQ21	1	1 unit	1CC	0.100	
		3VL9800-3JQ01	1	1 unit	1CC	0.100	
		3VL9800-3JQ11	1	1 unit	1CC	0.100	
	Leading auxiliary switch for Max Flex operating mechanism • 1 changeover contact with 1.5 m long cables • 2 changeover contacts with 1.5 m long cables		3VL9300-2AP11	1	1 unit	1CC	0.090
		3VL9300-2AP21	1	1 unit	1CC	0.154	

¹⁾ For safety lock as an assembly kit for retrofitting see pages 2/263 to 2/267.

²⁾ The knobs in monochrome gray or black are preferably used in IEC markets. Red/black knobs (red for ON) are standard in UL markets.

Version	DT	For VL150X UL (CG frame)	PU (UNIT, SET, M)	PS*/P. unit	PG	Weight per PU approx.
		Article No. www.siemens.com/product?Article No.	Price per PU			kg
Plug-in versions/withdrawable versions (UL file: E69455)						
3-pole						
Plug-in base assembly kits Complete with base plate, base, blade contacts for circuit breakers, terminal covers for degree of protection IP20, fixing screws, trip pin						
Rear terminals						
3-pole		3VL9100-4PA31		1	1 unit	1CC 2.710
Front-accessible connections						
3-pole		3VL9100-4PC31		1	1 unit	1CC 2.440
Blade contacts As replacement for converting fixed-mounted into plug-in/withdrawable molded case circuit breakers, including trip pin						
1 set = 6 units		3-pole 3VL9100-4PS31		1	1 unit	1CC 0.332
Trip pins and springs As replacement for plug-in molded case circuit breaker						
		3VL9100-4PF01		1	1 unit	1CC 0.013
Auxiliary circuit plug connections for plug-in bases¹⁾ Accessory connections for plug-in molded case circuit breakers (factory-wired connectors) and for plug-in bases (coupling with screw terminal)						
8 terminals ¹⁾		3VL9300-4PJ01		1	1 unit	1CC 0.221
Position signaling switches (Connected/disconnected position) For plug-in base, 1 CO, max. 2 signaling switches possible						
		3VL9000-4WL01		1	1 unit	1CC 0.040

¹⁾ It is recommended to use a maximum of 2 auxiliary circuit plug-in systems per molded case circuit breaker (16 terminals).

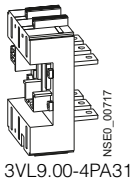

Molded Case Circuit Breakers

3VL Molded Case Circuit Breakers up to 1600 A, according to UL 489

Accessories and spare parts

2

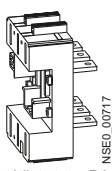
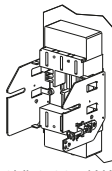
Version	DT	For VL150 UL (DG frame)	Price per PU	PU (UNIT, SET, M)	PS*/P. unit	PG	Weight per PU approx. kg		
Plug-in versions/withdrawable versions (UL file: E69455)									
 3VL9.00-4PA31	3-pole								
	Plug-in base assembly kits Complete with base plate, base, blade contacts for circuit breakers, terminal covers for degree of protection IP20, fixing screws, trip pin								
	Rear terminals 3-pole		3VL9200-4PA31		1	1 unit	1CC	2.500	
	Front-accessible connections 3-pole		3VL9200-4PC31		1	1 unit	1CC	2.530	
 3VL9.00-4WA31	Withdrawable versions Same as plug-in base assembly kit, with additional side panels and racking mechanism								
	Rear terminals 3-pole		3VL9200-4WA31		1	1 unit	1CC	5.231	
	Front-accessible connections 3-pole		3VL9200-4WC31		1	1 unit	1CC	4.987	
	Blade contacts As replacement for converting fixed-mounted into plug-in/withdrawable molded case circuit breakers, including trip pin 1 set = 6 units		3-pole	3VL9200-4PS31		1	1 unit	1CC	0.248
	Trip pins and springs As replacement for plug-in/withdrawable circuit breaker			3VL9300-4PF01		1	1 unit	1CC	0.013
	Auxiliary circuit plug connections for plug-in bases Accessory connections for plug-in molded case circuit breakers (factory-wired connectors) and for plug-in bases or withdrawable version (coupling with screw terminal) 8 terminals		1)	3VL9300-4PJ01		1	1 unit	1CC	0.221
	Position signaling switches (connected/disconnected position) For plug-in/withdrawable base, 1 CO, max. 2 signaling switches possible			3VL9000-4WL01		1	1 unit	1CC	0.040

1) It is recommended to use a maximum of 2 auxiliary circuit plug-in systems per molded case circuit breaker (16 terminals).

2) It is recommended to use a maximum of 3 auxiliary circuit plug-in systems per molded case circuit breaker (24 terminals).

Molded Case Circuit Breakers

3VL Molded Case Circuit Breakers up to 1600 A, according to UL 489

Accessories and spare parts

2

For VL250 UL (FG frame)					For VL400 UL (JG frame)								
DT	Article No. www.siemens.com/ product?Article No.	Price per PU	PU (UNIT, SET, M)	PS* P. unit	PG	Weight per PU approx. kg	DT	Article No. www.siemens.com/ product?Article No.	Price per PU	PU (UNIT, SET, M)	PS* P. unit	PG	Weight per PU approx. kg
	3VL9300-4PA31		1	1 unit	1CC	2.920		3VL9400-4PA31		1	1 unit	1CC	6.942
	3VL9300-4PC31		1	1 unit	1CC	2.672		3VL9400-4PC31		1	1 unit	1CC	42.000
	3VL9300-4WA31		1	1 unit	1CC	5.089		3VL9400-4WA31		1	1 unit	1CC	12.650
	3VL9300-4WC31		1	1 unit	1CC	4.940		3VL9400-4WC31		1	1 unit	1CC	6.500
	3VL9300-4PS31		1	1 unit	1CC	0.342		3VL9400-4PS31		1	1 unit	1CC	0.720
	3VL9300-4PF01		1	1 unit	1CC	0.013		3VL9400-4PF01		1	1 unit	1CC	0.015
	1) 3VL9300-4PJ01		1	1 unit	1CC	0.221		2) 3VL9400-4PJ01		1	1 unit	1CC	0.231
	3VL9000-4WL01		1	1 unit	1CC	0.040		3VL9000-4WL01		1	1 unit	1CC	0.040

Molded Case Circuit Breakers

3VL Molded Case Circuit Breakers up to 1600 A, according to UL 489



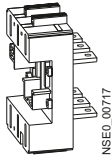
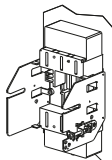

Accessories and spare parts

2

Version	DT	For VL400X (LG frame)	Price per PU	PU (UNIT, SET, M)	PS*/P. unit	PG	Weight per PU approx.	
kg								
Plug-in versions/withdrawable versions (UL file: E69455)								
 3VL9.00-4PA31	3-pole							
	Plug-in base assembly kits Complete with base plate, base, blade contacts for circuit breakers, terminal covers for degree of protection IP20, fixing screws, trip pin							
	Rear terminals 3-pole		3VL9460-4PA31		1	1 unit	1CC	8.200
	Front-accessible connections 3-pole		3VL9460-4PC31		1	1 unit	1CC	6.670
 3VL9.00-4WA31	Withdrawable versions Same as plug-in base assembly kit, with additional side panels and racking mechanism							
	Rear terminals¹⁾ 3-pole		3VL9460-4WA31		1	1 unit	1CC	11.500
	Front-accessible connections 3-pole		3VL9460-4WC31		1	1 unit	1CC	10.866
	Blade contacts As replacement for converting fixed-mounted into plug-in/withdrawable molded case circuit breakers, including trip pin 1 set = 6 units	3-pole	3VL9460-4PS31		1	1 unit	1CC	1.313
	Trip pins and springs As replacement for plug-in/withdrawable molded case circuit breaker		3VL9460-4PF01		1	1 unit	1CC	0.018
	Auxiliary circuit plug connections for plug-in bases²⁾ Accessory connections for plug-in molded case circuit breakers (factory-wired connectors) and for plug-in bases or withdrawable version (coupling with screw terminal) 8 terminals ²⁾		3VL9460-4PJ01		1	1 unit	1CC	0.316
	Position signaling switches (connected/disconnected position) For plug-in/withdrawable base, 1 CO, max. 2 signaling switches possible		3VL9000-4WL01		1	1 unit	1CC	0.040

¹⁾ With VL800 UL (MG frame) to VL1200 UL (NG frame) as vertical connection.

²⁾ It is recommended to use a maximum of 3 auxiliary circuit plug-in systems per molded case circuit breaker (24 terminals).

Version	DT	For VL150X UL (CG frame)	PU (UNIT, SET, M)	PS*/P. unit	PG	Weight per PU approx. kg
Connection parts for fixed-mounted molded case circuit breakers						
3-pole						
Rear terminals						
  NSE0_00723 3VL9.00-4RA01, 3VL9.00-4RB01	Short connection (1 unit)	3VL9100-4RA01	1	1 unit	1CC	0.158
	Long connection (1 unit)	3VL9100-4RB01	1	1 unit	1CC	0.261
	Terminal kit (2 short + 1 long) 3-pole	3VL9100-4RC31	1	1 unit	1CC	0.552
  NSE0_00724 3VL9.00-4RK01, 3VL9.00-4RL01	Short flat connection (1 unit)	3VL9100-4RK01	1	1 unit	1CC	0.126
	Long flat connection (1 unit)	3VL9100-4RL01	1	1 unit	1CC	0.222
	Flat connector kit (2 short + 1 long) 3-pole	3VL9100-4RM31	1	1 unit	1CC	0.462
Steel box terminal with auxiliary conductor connection						
Terminal with auxiliary conductor connection up to 0.5 A		3VL9120-4TN31	1	1 unit	1CC	0.269
Box terminals						
Connection for flexible flat copper busbar or cable		3VL9120-4TC31	1	1 unit	1CC	0.097
1 set = 3 units						
Circular conductor terminals¹⁾						
Only for cables (Al or Cu) Aluminum terminal (tinned)		3VL9130-4TD31	1	1 unit	1CC	0.093
1 set = 3 units						
Terminals with screw connection						
With insulator (for rear) for use with busbars and cable lugs		3VL9100-4TA31	1	1 unit	1CC	0.063
1 set = 3 units Metric thread						
Connection covers (terminal covers) for circuit breakers²⁾						
Degree of protection IP30 for main connections						
1 set = 2 units						
Extended 3-pole		3VL9300-8CA31	1	1 unit	1CC	0.306
Standard 3-pole		3VL9300-8CB31	1	1 unit	1CC	0.064
Connection covers (terminal covers) for circuit breakers						
Degree of protection IP2X for main connections						
1 set = 1 unit (consisting of top part and bottom part)						
3-pole		3VL9300-8CD31	1	1 unit	1CC	0.163
Phase barriers for molded case circuit breakers, fixed-mounted, plug-in or withdrawable versions						
1 set = 2 units		3VL9300-8CE01	1	1 unit	1CC	0.029

Note:

Only rear terminals with different lengths may be fitted next to one another (e.g. short-long-short or long-short-long).

¹⁾ Circular conductor terminals for VL150X UL (CG frame) suitable for 60 A to 150 A.

²⁾ UL-listed for use with plug-in and withdrawable versions. A system-specific additional test is required for use with circuit breakers.

Molded Case Circuit Breakers

3VL Molded Case Circuit Breakers up to 1600 A, according to UL 489

Accessories and spare parts

2

Version	DT	For VL150 UL (DG frame)	Price per PU	PU (UNIT, SET, M)	PS*/P. unit	PG	Weight per PU approx.
kg							
Connection parts for fixed-mounted molded case circuit breakers							
3-pole							
Front connecting bars							
		Terminal set with cover for mounting the circuit breaker on busbars	3VL9200-4EC31	1	1 unit	1CC	1.356
		1 set = 3 units					
Rear terminals							
		Short connection (1 unit)	3VL9200-4RA01	1	1 unit	1CC	0.165
		Long connection (1 unit)	3VL9200-4RB01	1	1 unit	1CC	0.271
		Terminal kit (2 short + 1 long)	3VL9200-4RC31	1	1 unit	1CC	0.566
		3-pole					
		Short flat connection (1 unit)	3VL9200-4RK01	1	1 unit	1CC	0.132
		Long flat connection (1 unit)	3VL9200-4RL01	1	1 unit	1CC	0.233
		Flat connector kit (2 short + 1 long)	3VL9200-4RM31	1	1 unit	1CC	0.460
		3-pole					
		Flat connecting bar (1 unit)	--				
		Flat connecting bars	--				
		1 set = 3 units, 3-pole					
Box terminal							
		Connection for flexible flat copper busbar or cable	3VL9220-4TC31	1	1 unit	1CC	0.115
		1 set = 3 units					
Circular conductor terminal with terminal covers for cable (only for Al or Cu cables)							
		Terminal with auxiliary conductor connection up to 0.5 A	3VL9215-4TD31	1	1 unit	1CC	0.356
		1 set = 3 units					
Steel box terminal with auxiliary conductor connection							
		Terminal with auxiliary conductor connection up to 0.5 A (FG frame up to 6.3 A)	3VL9220-4TN31	1	1 unit	1CC	0.277
Circular conductor terminals¹⁾							
		Only for cables (Al or Cu)	3VL9230-4TD31	1	1 unit	1CC	0.121
		Aluminum terminal (tinned)					
		1 set = 3 units					
Multiple feed-in terminals							
		Only for cables (Al or Cu)	--				
		Aluminum terminal (tinned)					
		1 set = 3 units					
Multiple feed-in terminal with terminal cover							
		Terminal with auxiliary conductor connection up to 0.5 A	--				
		1 set = 3 units					
		Double					

Note:

Only rear terminals with different lengths may be fitted next to one another (e.g. short-long-short or long-short-long).

¹⁾ Circular conductor terminals for VL150 UL suitable for 60 to 150 A.

Molded Case Circuit Breakers

3VL Molded Case Circuit Breakers up to 1600 A, according to UL 489

Accessories and spare parts

2





DT	For VL250 UL (FG frame)	Price per PU	PU (UNIT, SET, M)	PS*/P. unit	PG	Weight per PU approx.	DT	For VL400 UL (JG frame)	Price per PU	PU (UNIT, SET, M)	PS*/P. unit	PG	Weight per PU approx.
	Article No. www.siemens.com/product?Article No.					kg		Article No. www.siemens.com/product?Article No.					kg
	3VL9300-4EC31		1	1 unit	1CC	0.500		3VL9400-4EC31		1	1 unit	1CC	1.313
	3VL9300-4RA01		1	1 unit	1CC	0.164		3VL9400-4RA01		1	1 unit	1CC	0.428
	3VL9300-4RB01		1	1 unit	1CC	0.264		3VL9400-4RB01		1	1 unit	1CC	0.712
	3VL9300-4RC31		1	1 unit	1CC	0.555		3VL9400-4RC31		1	1 unit	1CC	1.203
	3VL9300-4RK01		1	1 unit	1CC	0.129		3VL9400-4RK01		1	1 unit	1CC	0.389
	3VL9300-4RL01		1	1 unit	1CC	0.224		3VL9400-4RL01		1	1 unit	1CC	0.700
	3VL9300-4RM31		1	1 unit	1CC	0.451		3VL9400-4RM31		1	1 unit	1CC	1.458
	--							--					
	--							--					
	3VL9335-4TC31		1	1 unit	1CC	0.204		3VL9460-4TC31		1	1 unit	1CC	0.463
	--							--					
	3VL9335-4TN31		1	1 unit	1CC	0.374		3VL9460-4TN31		1	1 unit	1CC	0.795
	3VL9335-4TD31		1	1 unit	1CC	0.150		3VL9475-4TD31		1	1 unit	1CC	0.353
	--							3VL9425-4TF31		1	1 unit	1CC	0.530
	--							3VL9460-4TF31		1	1 unit	1CC	0.899

Molded Case Circuit Breakers

3VL Molded Case Circuit Breakers up to 1600 A, according to UL 489

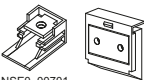
Accessories and spare parts

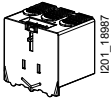
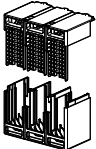
2

Version	DT	For VL150 UL (DG frame)	Price per PU	PU (UNIT, SET, M)	PS*/P. unit	PG	Weight per PU approx. kg
Connection parts for fixed-mounted molded case circuit breakers							
3-pole							
Connection with screw-type terminals							
With insulator (for rear) for use with busbars and cable lugs							
 NSE0_00701 3VL9.00-4TA.1	1 set = 3 units	Metric thread	3VL9200-4TA31	1	1 unit	1CC	0.075
	1 set = 3 units	Inch thread	3VL9200-4TB31	1	1 unit	1CC	0.068
 201_18984 3VL9220-4TM31	1 set = 3 units		3VL9220-4TM31	1	1 unit	1CC	0.262
Connection covers (terminal covers) for circuit breakers¹⁾							
Degree of protection IP30 for main connections							
1 set = 2 units							
 201_18987 3VL9.00-3CA.1	Extended	3-pole	3VL9300-8CA31	1	1 unit	1CC	0.306
	 NSE0_00730 3VL9.00-3CB.1	Standard	3-pole	3VL9300-8CB31	1	1 unit	1CC
Connection covers (terminal covers) for circuit breakers							
Degree of protection IP2X for main connections							
1 set = 1 unit (consisting of top part and bottom part)							
 201_18983 3VL9300-8CD31	3-pole		3VL9300-8CD31	1	1 unit	1CC	0.163
	Phase barriers for molded case circuit breakers, fixed-mounted, plug-in or withdrawable versions						
 NSE0_00731 3VL9.00-8CE01	1 set = 2 units		3VL9300-8CE01	1	1 unit	1CC	0.029

¹⁾ UL-listed for use with plug-in and withdrawable versions. A system-specific additional test is required for use with circuit breakers.

Molded Case Circuit Breakers

3VL Molded Case Circuit Breakers up to 1600 A, according to UL 489

Accessories and spare parts

2

DT	For VL250 UL (FG frame)	Price per PU	PU (UNIT, SET, M)	PS*/ P. unit	PG	Weight per PU approx.	DT	For VL400 UL (JG frame)	Price per PU	PU (UNIT, SET, M)	PS*/ P. unit	PG	Weight per PU approx.
	Article No. www.siemens.com/product?Article No.					kg		Article No. www.siemens.com/product?Article No.					kg
	3VL9300-4TA31		1	1 unit	1CC	0.102		3VL9400-4TA31		1	1 unit	1CC	0.116
	3VL9300-4TB31		1	1 unit	1CC	0.095		--					
	3VL9335-4TM31		1	1 unit	1CC	0.383		3VL9460-4TM31		1	1 unit	1CC	0.625
	3VL9300-8CA31		1	1 unit	1CC	0.306		3VL9400-8CA31		1	1 unit	1CC	0.615
	3VL9300-8CB31		1	1 unit	1CC	0.064		3VL9400-8CB31		1	1 unit	1CC	0.132
	3VL9300-8CD31		1	1 unit	1CC	0.163		3VL9400-8CD31		1	1 unit	1CC	0.308
	3VL9300-8CE01		1	1 unit	1CC	0.029		3VL9600-8CE01		1	1 unit	1CC	0.063

Molded Case Circuit Breakers

3VL Molded Case Circuit Breakers up to 1600 A, according to UL 489

Accessories and spare parts

2

Version	DT	For VL400X UL (LG frame)	PU (UNIT, SET, M)	PS*/P. unit	PG	Weight per PU approx. kg
Connection parts for fixed-mounted molded case circuit breakers						
3-pole						
Front connecting bars						
Terminal set with cover for mounting the circuit breaker on busbars 1 set = 3 units		3VL9460-4EC31	1	1 unit	1CC	2.145
Rear terminals						
Short connection (1 unit)		--				
Long connection (1 unit)		--				
Terminal kit (2 short + 1 long) 3-pole		--				
Short flat connection (1 unit)		--				
Long flat connection (1 unit)		3VL9460-4RP01	1	1 unit	1CC	0.810
Flat connector kit (2 short + 1 long) 3-pole		--				
Flat connecting bar (1 unit)		3VL9460-4RG01	1	1 unit	1CC	0.377
Flat connecting bars 1 set = 3 units, 3-pole		3VL9460-4RH31	1	1 unit	1CC	1.272
Box terminal						
Connection for flexible flat copper busbar or cable 1 set = 3 units		--				
Circular conductor terminals						
Only for cables (Al or Cu) Aluminum terminal (tinned)						
1 set = 3 units		3VL9475-4TD31	1	1 unit	1CC	0.353
Multiple feed-in terminals						
Only for cables (Al or Cu) Aluminum terminal (tinned)						
1 set = 3 units	Double	--				
	• Terminal on feeder side ¹⁾	3VL9460-4TX31	1	1 unit	1CC	0.822
	• Terminal on outgoing side ¹⁾	3VL9460-4TY31	1	1 unit	1CC	0.820
	3 times	--				
	4 times	--				
Connection with screw-type terminals						
With insulator (for rear) for use with busbars and cable lugs						
1 set = 3 units	Metric thread	3VL9460-4TA31	1	1 unit	1CC	0.171
1 set = 3 units	Inch thread	3VL9460-4TB31	1	1 unit	1CC	0.143
Connection covers (terminal covers) for circuit breakers²⁾						
Degree of protection IP30 for main connections 1 set = 2 units						
Extended	3-pole	3VL9400-8CA31	1	1 unit	1CC	0.615
Standard	3-pole	3VL9400-8CB31	1	1 unit	1CC	0.132
Phase barriers for molded case circuit breakers, fixed-mounted, plug-in or withdrawable versions³⁾						
1 set = 2 units		3VL9600-8CE01	1	1 unit	1CC	0.063

Note:

Only rear terminals with different lengths may be fitted next to one another (e.g. short-long-short or long-short-long).

- ¹⁾ Extended terminal cover included in scope of supply.
- ²⁾ UL-listed for use with plug-in and withdrawable versions. A system-specific additional test is required for use with circuit breakers.
- ³⁾ Plug-in versions: not for VL1200 UL (NG frame); withdrawable version: not for VL800 UL (MG frame) and VL1200 UL (NG frame).

Molded Case Circuit Breakers

3VL Molded Case Circuit Breakers up to 1600 A, according to UL 489

Accessories and spare parts

2

DT	For VL800 UL (MG frame)	Price per PU	PU (UNIT, SET, M)	PS*/ P. unit	PG	Weight per PU approx. kg	DT	For VL1200 UL (NG frame)	Price per PU	PU (UNIT, SET, M)	PS*/ P. unit	PG	Weight per PU approx. kg
	Article No. www.siemens.com/product?Article No.							Article No. www.siemens.com/product?Article No.					
	3VL9600-4EC31		1	1 unit	1CC	2.873		3VL9800-4EF01		1	1 unit	1CC	0.020
	--							--					
	3VL9600-4RP01		1	1 unit	1CC	1.653		--					
	3VL9600-4RG01		1	1 unit	1CC	1.305		3VL9700-4RG01		1	1 unit	1CC	1.708
	3VL9600-4RH31		1	1 unit	1CC	4.080		3VL9700-4RH31		1	1 unit	1CC	4.970
	--							--					
	3VL9675-4TF31		1	1 unit	1CC	1.228		--					
	3VL9650-4TG31		1	1 unit	1CC	1.130		3VL9775-4TG31		1	1 unit	1CC	3.414
	--							3VL9750-4TH31		1	1 unit	1CC	2.562
	3VL9600-4TA31		1	1 unit	1CC	0.340		3VL9800-4TA31		1	1 unit	1CC	0.362
	3VL9600-4TB31		1	1 unit	1CC	0.305		3VL9800-4TB31		1	1 unit	1CC	0.318
	3VL9600-8CA31		1	1 unit	1CC	0.910		3VL9800-8CA31		1	1 unit	1CC	1.268
	3VL9600-8CB31		1	1 unit	1CC	0.223		3VL9800-8CB31		1	1 unit	1CC	0.370
	3VL9600-8CE01		1	1 unit	1CC	0.063		3VL9800-8CE01		1	1 unit	1CC	0.150

Molded Case Circuit Breakers



3VL Molded Case Circuit Breakers up to 1600 A, according to UL 489

Accessories and spare parts

2

Version	DT	For VL1600 UL (PG frame)	PU (UNIT, SET, M)	PS*/P. unit	PG	Weight per PU approx. kg
Connection parts for fixed-mounted molded case circuit breakers						
3-pole						
Front connecting bars						
Terminal set with cover for mounting the circuit breaker on busbars 1 set = 3 units • Incoming side, mounting from the top • Incoming side, mounting from the bottom		3VL9800-4EF01	1	1 unit	1CC	0.020
Rear terminals						
Short connection (1 unit)		--				
Long connection (1 unit)		--				
Terminal kit (2 short + 1 long) 3-pole		--				
Short flat connection (1 unit)		--				
Long flat connection (1 unit)		--				
Flat connector kit (2 short + 1 long) 3-pole		--				
Flat connecting bar (1 unit)		--				
Flat connecting bars 1 set = 3 units, 3-pole		--				
Box terminal						
Connection for flexible flat copper busbar or cable 1 set = 3 units		--				
Circular conductor terminals						
Only for cables (Al or Cu) Aluminum terminal (tinned) 1 set = 3 units		--				
Multiple feed-in terminals						
Only for cables (Al or Cu) Aluminum terminal (tinned) 4-fold (for installation with mounting base) 1 units		3VL9875-4TH01	1	1 unit	1CC	1.223
Terminals with screw connection						
With insulator (for rear) for use with busbars and cable lugs 1 set = 3 units Metric thread		3VL9800-4TA31	1	1 unit	1CC	0.362
1 set = 3 units Inch thread		3VL9800-4TB31	1	1 unit	1CC	0.318
Connection covers (terminal covers) for circuit breakers¹⁾						
Degree of protection IP30 for main connections 1 set = 2 units						
Extended 3-pole		3VL9800-8CA31	1	1 unit	1CC	1.268
Standard 3-pole		3VL9800-8CB31	1	1 unit	1CC	0.370
Phase barriers for molded case circuit breakers, fixed-mounted						
1 set = 2 units		3VL9800-8CE01	1	1 unit	1CC	0.150
Mounting base						
Operation of the molded case circuit breaker within the scope of application of UL 489/CSA is permitted only in conjunction with the mounting base						
Front-accessible connections		3VL9800-4TU31	1	1 unit	1CC	24.830
Rear terminals		3VL9800-4TV31	1	1 unit	1CC	23.396

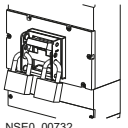
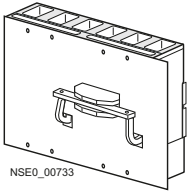
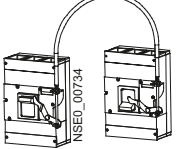
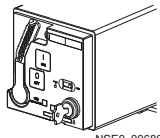
¹⁾ Not UL-listed.

Version	DT	For VL150X UL (CG frame) and VL150 UL (DG frame)	PU (UNIT, SET, M)	PS*/P. unit	PG	Weight per PU approx. kg
		Article No. www.siemens.com/product?Article No. Price per PU				
Interlocks						
3-pole						
 NSE0_00732 3VL9.00-3HL01		Locking devices for toggle levers For locking the molded case circuit breaker in the "OFF" position. Up to 3 padlocks with Ø 5–8 mm can be used. Removable (padlocks not included)	3VL9300-3HL01	1	1 unit	1CC 0.074
 NSE0_00733 3VL9.00-8L.01		Rear interlocking modules For the mechanical interlocking of two adjacent molded case circuit breakers. The circuit breakers must be of the same installation type and frame size. (Mounting plate not included in scope of supply) Fixed-mounted molded case circuit breakers	3VL9300-8LC01	1	1 unit	1CC 0.473
 NSE0_00734 3VL9.00-8LA01		Interlocking modules for Bowden wire interlocking¹⁾ For the mechanical interlocking of two molded case circuit breakers. Interlocking module for one molded case circuit breaker	3VL9300-8LA01	1	1 unit	1CC 0.194
		Note Combinations with next size up/down possible (see Article No.)				
		Bowden wires for Bowden wire interlocking ¹⁾				
		• Wire length 0.5 m	3VL9000-8LH11	1	1 unit	1CC 0.330
		• Wire length 1.0 m	3VL9000-8LH21	1	1 unit	1CC 0.400
		• Wire length 1.5 m	3VL9000-8LH31	1	1 unit	1CC 0.533
		Sets of fixing screws (metric thread) Including the screws, washers and nuts required to secure a molded case circuit breaker to a prepared surface Set with 4 screws	3VL9300-8SA40	1	1 unit	1CC 0.053
 NSE0_00680 3VL9.00-8L.01		Safety lock assembly kits Key can be removed with the molded case circuit breaker in the "OFF" position <u>For front-operated rotary operating mechanisms</u> Ronis lock type <u>For motorized operating mechanism with stored energy mechanism</u> Filli Giussani lock type	3VL9715-8HA01 3VL9321-8HA01	1	1 unit	1CC 0.271 1CC 0.041
		Transparent covers for releases, sealable To prevent access by unqualified personnel and unauthorized changes to settings (seal not included)				
 201_88185 3VL9...-8B.01		• Electronic Trip Unit • Thermal-magnetic ²⁾	3VL9700-8BL01 3VL9300-8BM01	1	1 unit	1CC 0.013 1CC 0.020
 NSE0_01874 3VL9000-8AP01		Battery power supply for activating/parameterizing/tripping the electronic trip units (two 9 V blocks are required in addition)	3VL9000-8AP01	1	1 unit	1CC 0.208

¹⁾ Two interlocking modules and one Bowden wire are required. Cannot be used in conjunction with motorized operating mechanism!



²⁾ Also suitable for VL150X UL (CG frame).

Molded Case Circuit Breakers

3VL Molded Case Circuit Breakers up to 1600 A, according to UL 489

Accessories and spare parts

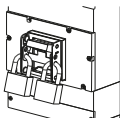
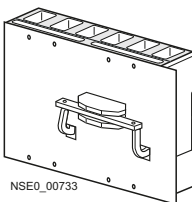
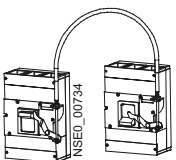
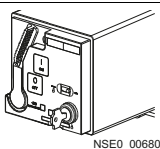
2

Version	DT	For VL250 UL (FG frame) Article No. www.siemens.com/ product?Article No.	Price per PU	PU (UNIT, SET, M)	PS*/ P. unit	PG	Weight per PU approx. kg
Interlocks							
 NSE0_00732 3VL9.00-3HL01	3-pole Locking devices for toggle levers For locking the molded case circuit breaker in the "OFF" position. Up to 3 padlocks with Ø 5–8 mm can be used. Removable (padlocks not included)	3VL9300-3HL01		1	1 unit	1CC	0.074
 NSE0_00733 3VL9.00-8L.01	Rear interlocking modules For the mechanical interlocking of two adjacent molded case circuit breakers. The circuit breakers must be of the same installation type and frame size. (Mounting plate not included in scope of supply) Fixed-mounted molded case circuit breakers	3VL9300-8LC01		1	1 unit	1CC	0.473
 NSE0_00734 3VL9.00-8LA01	Interlocking modules for Bowden wire interlocking¹⁾ For the mechanical interlocking of two molded case circuit breakers. Interlocking module for one molded case circuit breaker Note Combinations with next size up/down possible (see Article No.)	3VL9300-8LA01		1	1 unit	1CC	0.194
	Bowden wires for Bowden wire interlocking ¹⁾ <ul style="list-style-type: none"> • Wire length 0.5 m • Wire length 1.0 m • Wire length 1.5 m 	3VL9000-8LH11 3VL9000-8LH21 3VL9000-8LH31		1 1 1	1 unit 1 unit 1 unit	1CC 1CC 1CC	0.330 0.400 0.533
 NSE0_00680 3VL9...-8HA01	Safety lock assembly kits Key can be removed with the molded case circuit breaker in the "OFF" position For motorized operating mechanism with stored energy mechanism Lock types <ul style="list-style-type: none"> • Ronis • Filli Giussani 	--- 3VL9321-8HA01		1	1 unit	1CC	0.041
	Sets of fixing screws (metric thread) Including the screws, washers and nuts required to secure a molded case circuit breaker to a prepared surface Set with 4 screws	3VL9300-8SA40		1	1 unit	1CC	0.053
 120 L 18985 3VL9...-8B.01	Transparent covers for releases, sealable To prevent access by unqualified personnel and unauthorized changes to settings (seal not included) <ul style="list-style-type: none"> • For Electronic Trip Unit • For thermal-magnetic release 	3VL9700-8BL01 3VL9300-8BM01		1 1	1 unit 1 unit	1CC 1CC	0.013 0.020
 SIEMENS 9V 1480...01314 3VL9000-8AP01	Battery power supply for activating/parameterizing/tripping the Electronic Trip Units (two 9 V blocks are required in addition)	3VL9000-8AP01		1	1 unit	1CC	0.208

¹⁾ Two interlocking modules and one Bowden wire are required. Cannot be used in conjunction with motorized operating mechanism!

Molded Case Circuit Breakers

3VL Molded Case Circuit Breakers up to 1600 A, according to UL 489

Accessories and spare parts

2



DT	For VL400 UL (JG frame)	Price per PU	PU (UNIT, SET, M)	PS*/ P. unit	PG	Weight per PU approx. kg	DT	For VL400X UL (LG frame)	Price per PU	PU (UNIT, SET, M)	PS*/ P. unit	PG	Weight per PU approx. kg
	Article No. www.siemens.com/product?Article No.							Article No. www.siemens.com/product?Article No.					
	3VL9400-3HL01		1	1 unit	1CC	0.140		3VL9400-3HL01		1	1 unit	1CC	0.140
	3VL9400-8LC01		1	1 unit	1CC	0.386		3VL9400-8LC01		1	1 unit	1CC	0.386
	3VL9400-8LA01		1	1 unit	1CC	0.235		3VL9400-8LA01		1	1 unit	1CC	0.235
	--							--					
	3VL9000-8LH21		1	1 unit	1CC	0.400		3VL9000-8LH21		1	1 unit	1CC	0.400
	3VL9000-8LH31		1	1 unit	1CC	0.533		3VL9000-8LH31		1	1 unit	1CC	0.533
	3VL9715-8HA01		1	1 unit	1CC	0.271		3VL9715-8HA01		1	1 unit	1CC	0.271
	--							--					
	3VL9500-8SA40		1	1 unit	1CC	0.109		3VL9500-8SA40		1	1 unit	1CC	0.109
	3VL9700-8BL01		1	1 unit	1CC	0.013		3VL9700-8BL01		1	1 unit	1CC	0.013
	3VL9400-8BM01		1	1 unit	1CC	0.035		3VL9400-8BM01		1	1 unit	1CC	0.035
	3VL9000-8AP01		1	1 unit	1CC	0.208		3VL9000-8AP01		1	1 unit	1CC	0.208

Molded Case Circuit Breakers

3VL Molded Case Circuit Breakers up to 1600 A, according to UL 489

Accessories and spare parts

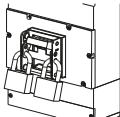
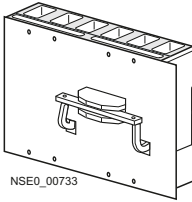
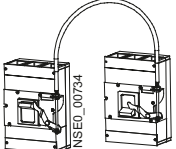
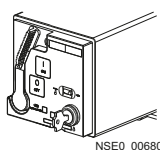
2

Version	DT	For VL800 UL (MG frame) Article No. www.siemens.com/ product?Article No.	Price per PU	PU (UNIT, SET, M)	PS*/ P. unit	PG	Weight per PU approx. kg
Interlocks							
 NSE0_00732 3VL9.00-3HL01		3-pole Locking devices for toggle levers For locking the molded case circuit breaker in the "OFF" position. Up to 3 padlocks with Ø 5–8 mm can be used. Removable (padlocks not included)					3VL9600-3HL01 1 1 unit 1CC 0.130
 NSE0_00733 3VL9.00-8L.01		Rear interlocking modules For the mechanical interlocking of two adjacent molded case circuit breakers. The circuit breakers must be of the same installation type and frame size. (Mounting plate not included in scope of supply) Fixed-mounted molded case circuit breakers					3VL9600-8LC01 1 1 unit 1CC 4.360
 NSE0_00734 3VL9.00-8LA01		Interlocking modules for Bowden wire interlocking¹⁾ For the mechanical interlocking of two molded case circuit breakers. Interlocking module for one molded case circuit breaker					3VL9600-8LA01 1 1 unit 1CC 0.269
		Bowden wires for Bowden wire interlocking ¹⁾ <ul style="list-style-type: none"> • Wire length 0.5 m • Wire length 1.0 m • Wire length 1.5 m 					-- 3VL9000-8LH21 1 1 unit 1CC 0.400 3VL9000-8LH31 1 1 unit 1CC 0.533
 NSE0_00680 3VL9....-8HA01		Safety lock assembly kits Key can be removed with the molded case circuit breaker in the "OFF" position <u>For motorized operating mechanism with stored energy mechanism</u> Lock types <ul style="list-style-type: none"> • Ronis • Filli Giussani 					3VL9715-8HA01 -- 1 1 unit 1CC 0.271
		Sets of fixing screws (metric thread) Including the screws, washers and nuts required to secure a molded case circuit breaker to a prepared surface Set with 4 screws					3VL9600-8SA40 1 1 unit 1CC 0.118
 120_13885 3VL9...-8B.01		Transparent covers for releases, sealable To prevent access by unqualified personnel and unauthorized changes to settings (seal not included) <ul style="list-style-type: none"> • For Electronic Trip Unit • For thermal-magnetic release 					3VL9700-8BL01 -- 1 1 unit 1CC 0.013
 3VL9000-8AP01		Battery power supply for activating/parameterizing/tripping the Electronic Trip Units (two 9 V blocks are required in addition)					3VL9000-8AP01 1 1 unit 1CC 0.208

¹⁾ Two interlocking modules and one Bowden wire are required.
 Cannot be used in conjunction with motorized operating mechanism!

Molded Case Circuit Breakers

3VL Molded Case Circuit Breakers up to 1600 A, according to UL 489

Accessories and spare parts

2

DT	For VL1200 UL (NG frame)	Price per PU	PU (UNIT, SET, M)	PS*/ P. unit	PG	Weight per PU approx. kg	DT	For VL1600 UL (PG frame)	Price per PU	PU (UNIT, SET, M)	PS*/ P. unit	PG	Weight per PU approx. kg
	3VL9800-3HL01		1	1 unit	1CC	0.250		3VL9800-3HL01		1	1 unit	1CC	0.250
	3VL9800-8LC01		1	1 unit	1CC	4.262		3VL9800-8LC01		1	1 unit	1CC	4.262
	3VL9800-8LA01		1	1 unit	1CC	0.298		3VL9800-8LA01		1	1 unit	1CC	0.298
	-- 3VL9000-8LH31		1	1 unit	1CC	0.533		-- 3VL9000-8LH31		1	1 unit	1CC	0.533
	3VL9715-8HA01 --		1	1 unit	1CC	0.271		3VL9715-8HA01 --		1	1 unit	1CC	0.271
	3VL9800-8SA40		1	1 unit	1CC	0.116		3VL9800-8SA40		1	1 unit	1CC	0.116
	3VL9700-8BL01 --		1	1 unit	1CC	0.013		3VL9700-8BL01 --		1	1 unit	1CC	0.013
	3VL9000-8AP01		1	1 unit	1CC	0.208		3VL9000-8AP01		1	1 unit	1CC	0.208

Molded Case Circuit Breakers

3VL Molded Case Circuit Breakers up to 1600 A, according to UL 489

Accessories and spare parts

2

Version	DT	For VL150X UL (CG frame)	PU (UNIT, SET, M)	PS*/P. unit	PG	Weight per PU approx.
		Article No. www.siemens.com/product?Article No.	Price per PU			kg

Further accessories

3-pole

Masking frames (cover frames) For door cutouts

A Fixed-mounted or plug-in molded case circuit breaker

IP40

3VL9300-8BC01

1 1 unit 1CC 0.054

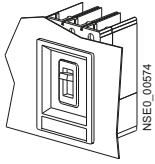

Masking frame A

B¹⁾ Fixed-mounted, plug-in or withdrawable molded case circuit breaker with front-operated rotary operating mechanism or motorized operating mechanism

IP40

3VL9300-8BG01

1 1 unit 1CC 0.114

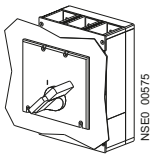

Masking frame B

C Withdrawable molded case circuit breaker with toggle lever actuation. Assembly kit contains masking frame and extended escutcheon (cannot be used together with a motorized operating mechanism/rotary operating mechanism)

IP20

--

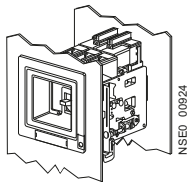

Masking frame C

Version	DT	For VL800 UL (MG frame)	PU (UNIT, SET, M)	PS*/P. unit	PG	Weight per PU approx.
		Article No. www.siemens.com/product?Article No.	Price per PU			kg

Further accessories

3-pole

Masking frames (cover frames) For door cutouts

A Fixed-mounted or plug-in molded case circuit breaker

IP40

3VL9600-8BC01

1 1 unit 1CC 0.074

B¹⁾ Fixed-mounted, plug-in or withdrawable molded case circuit breaker with front-operated rotary operating mechanism or motorized operating mechanism

IP40

3VL9600-8BG01

1 1 unit 1CC 0.192

C Withdrawable molded case circuit breaker with toggle lever actuation. Assembly kit contains masking frame and extended escutcheon (cannot be used together with a motorized operating mechanism/rotary operating mechanism)

IP20

3VL9600-8BH01

1 1 unit 1CC 0.259

¹⁾ For withdrawable version IP20.

Molded Case Circuit Breakers

3VL Molded Case Circuit Breakers up to 1600 A, according to UL 489

Accessories and spare parts

2

DT	For VL150 UL (DG frame) and VL250 UL (FG frame)	Price per PU	PU (UNIT, SET, M)	PS*/P. unit	PG	Weight per PU approx.	DT	For VL400 UL (JG frame) and VL400X UL (LG frame)	Price per PU	PU (UNIT, SET, M)	PS*/P. unit	PG	Weight per PU approx.
	Article No. www.siemens.com/product?Article No.					kg		Article No. www.siemens.com/product?Article No.					kg

3VL9300-8BC01

1 1 unit 1CC 0.054

3VL9400-8BC01

1 1 unit 1CC 0.046

3VL9300-8BG01

1 1 unit 1CC 0.114

3VL9400-8BG01

1 1 unit 1CC 0.163

3VL9300-8BH01

1 1 unit 1CC 0.325

3VL9400-8BH01

1 1 unit 1CC 0.435

DT	For VL1200 UL (NG frame)	Price per PU	PU (UNIT, SET, M)	PS*/P. unit	PG	Weight per PU approx.	DT	For VL1600 UL (PG frame)	Price per PU	PU (UNIT, SET, M)	PS*/P. unit	PG	Weight per PU approx.
	Article No. www.siemens.com/product?Article No.					kg		Article No. www.siemens.com/product?Article No.					kg

3VL9800-8BC01

1 1 unit 1CC 0.054

3VL9800-8BC01

1 1 unit 1CC 0.054

3VL9800-8BG01

1 1 unit 1CC 0.223

3VL9800-8BG01

1 1 unit 1CC 0.223

3VL9800-8BH01

1 1 unit 1CC 0.380

3VL9800-8BH01

1 1 unit 1CC 0.380

Molded Case Circuit Breakers

3VL Molded Case Circuit Breakers up to 1600 A, according to UL 489

Accessories and spare parts

2

Version	DT	Article No. www.siemens.com/ product?Article No.	Price per PU	PU (UNIT, SET, M)	PS* P. unit	PG	Weight per PU approx. kg
---------	----	---	-----------------	-------------------------	----------------	----	-----------------------------------

Further accessories

3-pole

Current transformers for N-conductor/grounded neutral point of the transformer

for ground-fault protection in 4-wire three-phase systems

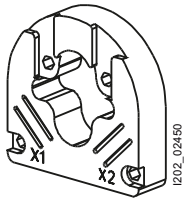

3VL9206-8TT01

I_n /A of the ETU	Purpose	Article No.	Price per PU	PU (UNIT, SET, M)	PS* P. unit	PG	Weight per PU approx. kg
60	for VL150 UL (DG frame)	3VL9206-8TT01		1	1 unit	1CC	0.100
100	for VL150 UL (DG frame)	3VL9310-8TT01		1	1 unit	1CC	0.200
	for VL250 UL (FG frame)	3VL9310-8TT01		1	1 unit	1CC	0.200
150	for VL150 UL (DG frame)	3VL9315-8TT01		1	1 unit	1CC	0.045
	for VL250 UL (FG frame)	3VL9315-8TT01		1	1 unit	1CC	0.045
250	for VL250 UL (FG frame)	3VL9425-8TT01		1	1 unit	1CC	0.200
	for VL400 UL (JG frame)	3VL9425-8TT01		1	1 unit	1CC	0.200
400	for VL400 UL (JG frame)	3VL9440-8TT01		1	1 unit	1CC	0.100
	for VL400X UL (LG frame)	3VL9440-8TT01		1	1 unit	1CC	0.100
600	for VL400X UL (LG frame)	3VL9660-8TT01		1	1 unit	1CC	0.100
	for VL800 UL (MG frame)	3VL9660-8TT01		1	1 unit	1CC	0.100
800	for VL800 UL (MG frame)	3VL9780-8TT01		1	1 unit	1CC	0.020
	for VL1200 UL (NG frame)	3VL9780-8TT01		1	1 unit	1CC	0.020
1000	for VL1200 UL (NG frame)	3VL9812-8TT01		1	1 unit	1CC	0.075
1200	for VL1200 UL (NG frame)	3VL9812-8TT01		1	1 unit	1CC	0.075
	for VL1600 UL (PG frame)	3VL9812-8TT01		1	1 unit	1CC	0.075
1600	for VL1600 UL (PG frame)	3VL9816-8TT01		1	1 unit	1CC	0.100

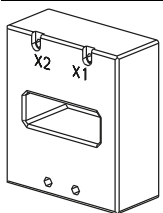

3VL9660-8TT01

For type	Version	DT	Article No. www.siemens.com/ product?Article.No.	Price per PU	PU (UNIT, SET, M)	PS*/ P. unit	PG	Weight per PU approx. kg
----------	---------	----	--	-----------------	----------------------------	-----------------	----	---------------------------------------

Accessories for communication

3-pole

Data transmission

VL150 UL (DG frame) to VL1600 UL (PG frame)	COM20 Release 2 (PROFIBUS module for 3VL molded case circuit breaker according to UL) Module for connecting the 3VL molded case circuit breaker according to UL with Electronic Trip Unit to the PROFIBUS DP, including switching function and Zone Selective Interlocking functionality, connection cable to ETU not included in delivery		3VL9000-8AU00		1	1 unit	1CC	0.287
VL150 UL (DG frame) to VL1600 UL (PG frame)	COM21 Release 2 (Modbus module for 3VL molded case circuit breaker according to UL) Module for connecting the 3VL molded case circuit breaker according to UL with electronic trip unit to a Modbus RTU bus system, including switching function and Zone Selective Interlocking functionality, connection cable to ETU not included in delivery		3VL9000-8AV00		1	1 unit	1CC	0.295
	Addressing plugs For assigning the module addresses without using a PC/PG on COM20/COM21 (Release 2) through the system interface	▶	3UF7910-0AA00-0		1	1 unit	42J	0.015
VL150 UL (DG frame) to VL250 UL (FG frame)	COMKIT3 Communication interface for connecting a 3VL molded case circuit breaker according to UL to a COM20/COM21 (Release 2) communication module. Comprising: • Connecting cable length 1.5 m • Alarm switches • Protective cover to protect the connecting cable		3VL9300-8AQ61		1	1 unit	1CC	0.142
VL400 UL (JG frame) to VL400X UL (LG frame)	COMKIT4 Communication interface for connecting a 3VL molded case circuit breaker according to UL to a COM20/COM21 (Release 2) communication module. Comprising: • Connecting cable length 1.5 m • Auxiliary Switches and Alarm Switches • Protective cover to protect the connecting cable		3VL9400-8AQ61		1	1 unit	1CC	0.145
VL600 UL (MG frame) to VL1600 UL (PG frame)	COMKIT5 Communication interface for connecting a 3VL molded case circuit breaker according to UL to a COM20/COM21 (Release 2) communication module. Comprising: • Connecting cable length 1.5 m • Auxiliary Switches and Alarm Switches • Protective cover to protect the connecting cable		3VL9800-8AQ61		1	1 unit	1CC	0.181
VL150 UL (DG frame) to VL250 UL (FG frame)	COMKIT6 Communication interface for connecting a 3VL molded case circuit breaker according to UL to a COM20/COM21 (Release 2) communication module. Comprising: • Connecting cable length 3 m • Alarm switches • Protective cover to protect the connecting cable		3VL9300-8AQ71		1	1 unit	1CC	0.205
VL400 UL (JG frame) to VL400X UL (LG frame)	COMKIT7 Communication interface for connecting a 3VL molded case circuit breaker according to UL to a COM20/COM21 (Release 2) communication module. Comprising: • Connecting cable length 3 m • Auxiliary Switches and Alarm Switches • Protective cover to protect the connecting cable		3VL9400-8AQ71		1	1 unit	1CC	0.214
VL600 UL (MG frame) to VL1600 UL (PG frame)	COMKIT8 Communication interface for connecting a 3VL molded case circuit breaker according to UL to a COM20/COM21 (Release 2) communication module. Comprising: • Connecting cable length 3 m • Auxiliary Switches and Alarm Switches • Protective cover to protect the connecting cable		3VL9800-8AQ71		1	1 unit	1CC	0.246

Molded Case Circuit Breakers

3VL Molded Case Circuit Breakers up to 1600 A, according to UL 489

General data

Design

- Rated current range from 20 A to 1600 A
- Different making and breaking capacities for each size

N	Standard (35 kA)
H	High (65 kA)
L	Very high (100 kA)

- No power reduction/derating up to 40 °C
- Electronic Trip Unit from size 150 A (VL150 UL, DG frame), especially for time-based discrimination and ground-fault protection
- 2 families of internal accessories
- Complete bandwidth of external accessories, e.g. terminals also for aluminum cables.

All molded case circuit breakers are supplied with integrated overcurrent releases. The VL150X UL (CG frame) to VL1600 UL (PG frame) molded case circuit breakers are available with different connection variants (see "Main connections, basic equipment and options", page 2/276). Auxiliary switches, alarm switches and auxiliary releases can be easily retrofitted in the molded case circuit breakers or, if requested, are already installed when delivered.

The breaking capacity is indicated on the front of every molded case circuit breaker.

- Standard breaking capacity:
35 kA at 50/60 Hz 480 V AC
- High breaking capacity:
65 kA at 50/60 Hz 480 V AC
- Very high breaking capacity:
100 kA at 50/60 Hz 480 V AC

Connection

The following connection types are available for 3VL molded case circuit breakers according to UL 489:

- Box terminal, suitable for stranded conductors,
- Screw terminals for flat connection,
- Circular conductor/multiple feed-in terminal for Al/Cu cables,
- Cable lug connection.

The infeed and outgoing sides can be chosen on the molded case circuit breaker to suit requirements. The electrical data remains unaffected.

Various terminals feature an auxiliary conductor connection. Up to 0.5 A can be tapped here to directly power other devices.

Bare conductors at the top terminals must be insulated in the space that is needed above the arc chute.

All auxiliary releases (shunt releases and undervoltage releases), auxiliary switches and alarm switches are equipped with screw terminals and therefore are easy to connect electrically.

The motorized operating mechanisms with spring energy store always feature terminals. The leading auxiliary switches for the rotary operating mechanisms are always supplied with connecting cables.

VL 150X UL (CG frame) to VL 1600 UL (PG frame) molded case circuit breakers

The main components of the 3VL molded case circuit breakers according to UL are the three conducting paths with incoming and outgoing terminals. The fixed and movable contacts are designed in such a way that magnetic repulsion of the contacts takes place under short-circuit conditions. In conjunction with the arc splitter chambers, a dynamic impedance is created that causes a current limitation through the reduction in the harmful effects of I^2t and the I_p energy resulting during short-circuits.

The 3VL molded case circuit breaker has a trip-free mechanism.

The double-insulated accessory compartments for the auxiliary releases and auxiliary switches are located on the left and right of the circuit breaker's operating mechanism.

The overcurrent releases for the VL150X UL (CG frame) to VL1600 UL (PG frame) molded case circuit breakers have the following characteristics:

- The overcurrent releases are available in a thermal-magnetic version and in an electronic¹⁾ version.
- The thermal-magnetic releases have non-adjustable overload releases and adjustable²⁾ short-circuit releases.

In the case of all versions of the 3VL molded case circuit breakers according to UL with electronic overcurrent release, the current transformers are in the same enclosure as the tripping electronics. They supply a signal proportional to the load current to the electronic overcurrent release system.

All 3VL molded case circuit breakers according to UL with electronic overcurrent release measure the actual rms current. This is the most accurate method of measurement. Currents in present-day electrical distribution systems with very high harmonics are evaluated reliably.

Overcurrent tripping systems

The switching unit (frame) and release unit are assembled and tested at the factory. Accordingly, the release unit can only be replaced at the factory. The infeed and outgoing sides can be chosen on the molded case circuit breakers to suit requirements.

1. Thermal-magnetic releases of the VL150X UL (CG frame) to VL1600 UL (PG frame) molded case circuit breakers

The overcurrent releases and short-circuit releases work with bimetals and magnetic releases. They are available with non-adjustable overload releases and adjustable short-circuit releases.²⁾

The 3VL molded case circuit breakers for starter combination applications are usually combined with a motor contactor and a suitable overload relay.

¹⁾ VL 150X UL (CG frame) only thermal-magnetic.

²⁾ VL 150X UL (CG frame) only with non-adjustable short-circuit release.

The non-automatic air circuit breakers have integrated self-protection against short-circuit so that back-up fuses can be omitted. Non-automatic air circuit breakers do not have overload protection.

2. Overcurrent releases of the VL150X UL (DG frame) to VL1600 UL (PG frame) molded case circuit breakers, electronic, ETU

The electronic tripping system consists of:

- 3 current transformers
- Evaluation electronics with microprocessor
- Intrinsic power supply, no external auxiliary power necessary
- Tripping solenoid.

In the case of VL150 UL (DG frame) and VL250 (FG frame) molded case circuit breakers, the left accessory compartment is needed for the tripping solenoid included in the scope of supply. In the case of all other sizes, the tripping solenoid is integrated in the release unit and the left and right accessory compartments can be used for auxiliary switches, alarm switches and additional auxiliary releases.

The protection functions of the electronic trip units are ensured without additional auxiliary voltage. The overcurrent releases are supplied with energy via internal current transformers in the circuit breaker.

3. Overcurrent releases of the VL150X UL (DG frame) to VL1600 UL (PG frame) molded case circuit breakers

For parameterizing, the electronic overcurrent release must be activated. A load current amounting to at least 20 % of the relevant molded case circuit breaker's rated current I_n is needed to do this. If this load current is not available, the necessary auxiliary energy can be supplied via a battery power supply. In the case of molded case circuit breakers that are connected to an active COM20 (PROFIBUS) or COM21 (Modbus) communication module (Release 2) for data transmission, the release is powered via the module.

Abbreviations (functions)		
L	= Long Time Delay	= Overload protection
S	= Short Time Delay	= Short-circuit protection (short-time delayed)
I	= Instantaneous	= Short-circuit protection (instantaneous)
N	= Neutral Protection	= Neutral conductor protection
G	= Ground Fault	= Ground-fault protection

Molded Case Circuit Breakers

3VL Molded Case Circuit Breakers up to 1600 A, according to UL 489

General data

VL150 UL (DG frame) to VL1600 UL (PG frame) overcurrent releases – functional overview

Article No. supplement	Release/model	Line protection	Starter protection	Generator protection	Function	Setting options				
						L ¹⁾	S ¹⁾	I ¹⁾	G ¹⁾	
						Overload protection	Short-circuit protection (short-time delayed)	Short-circuit protection (instantaneous)	Ground-fault protection	
						$I_r = \times I_n$	$I_{sd} = \times I_r$	t_{sd} [s]	$I_n = \times I_n$	$I_g = \times I_n$
KJ	M	--	✓	--	I	--	--	--	3 ... 6	--
KK	M	--	✓	--	I	--	--	--	4 ... 10	--
KL	M	--	✓	--	I	--	--	--	7 ... 16	--
KN	TM/525	✓	--	--	LI	1	--	--	5 ... 10	--
PB	ETU/555	✓	--	--	LI	0.4 ... 1	--	--	1.25 ... 11	--
PD	ETU/555	✓	--	--	LIG	0.4 ... 1	--	--	1.25 ... 11	0.4 ... 1 ³⁾
PU	ETU/555	✓	--	✓	LSI	0.4 ... 1	1.5 ... 10	0 ... 0.5	1.25 ... 11	--
PH	ETU/555	✓	--	✓	LSIG	0.4 ... 1	1.5 ... 10	0 ... 0.5	1.25 ... 11	0.4 ... 1 ³⁾
VH	LCD-ETU/586	✓	--	--	LI, LSI	0.4 ... 1	1.25 ... 10	0 ... 0.5	1.25 ... 11	--
VM	LCD-ETU/586	✓	--	--	LSIG	0.4 ... 1	1.25 ... 10	0 ... 0.5	1.25 ... 11	0.4 ... 1 ²⁾
VJ	LCD-ETU/586	✓	--	--	LSI G (alarm)	0.4 ... 1	1.25 ... 10	0 ... 0.5	1.25 ... 11	0.4 ... 1 ²⁾

Article No. supplement	Release/model	Thermal image	Communication-capable	Ground-fault protection	Number of poles	I^2t (ON/OFF)	Time-lag class (t_r)	Thermal-magnetic releases	Magnetic releases	Electronic release	LCD display
KJ	M	--	--	--	3	--	--	--	✓	--	--
KK	M	--	--	--	3	--	--	--	✓	--	--
KL	M	--	--	--	3	--	--	--	✓	--	--
KN	TM/525	✓	--	--	3	--	--	✓	--	--	--
PB	ETU/555	✓	✓	--	3	--	2.5 ... 30	--	--	✓	--
PD	ETU/555	✓	✓	①	3	--	2.5 ... 30	--	--	✓	--
PU	ETU/555	✓	✓	--	3	✓	--	--	--	✓	--
PH	ETU/555	✓	✓	①	3	✓	--	--	--	✓	--
VH	LCD-ETU/586	✓	✓	--	3	✓	2.5 ... 30	--	--	✓	✓
VM	LCD-ETU/586	✓	✓	① / ②	3	✓	2.5 ... 30	--	--	✓	✓
VJ	LCD-ETU/586	✓	✓	① / ②	3	✓	2.5 ... 30	--	--	✓	✓

Ground-fault protection

- ① Vectorial summation current formation (4-conductor system)
- ② Direct detection of ground-fault current in the neutral point of the transformer

1) Size dependent.

2) t_g 0.1 s to 0.5 s.

3) t_g 0.07 s to 0.4 s size-dependent

Internal accessories (auxiliary switches, undervoltage releases, shunt releases)

3VL molded case circuit breakers according to UL can be supplied completely equipped with internal accessories (e.g. auxiliary switches, undervoltage releases or shunt releases). Refer to the tables of Article No. supplements for details of possible versions.

Fixed-mounted, plug-in or withdrawable version

The fixed-mounted molded case circuit breaker is the basic version. Using the appropriate assembly kit, it can be changed to a plug-in or withdrawable version. This assembly kit contains blade contacts, a locking pin and terminal covers for the plug-in version. The assembly kit for the withdrawable version additionally includes side panels and a racking mechanism. Even when the masking frame is fitted, movement using the withdrawable unit's handle is possible while the door is closed.

Operating mechanisms

In the basic version, the 3VL molded case circuit breakers according to UL have a toggle lever as an operating mechanism. This also functions as an indicator of the switch position. The "Tripped" position is also displayed in addition to the "ON" and "OFF" positions.

The toggle lever goes to the "tripped" position when the internal tripping mechanism is activated by overcurrent tripping, e.g. on overload or short-circuit. Activation of an undervoltage release or shunt release will also cause the toggle lever to move to the "Tripped" position. The toggle lever must be moved to the "OFF/RESET" position before the molded case circuit breaker can be closed again. This enables reset of the internal tripping mechanism and reactivation of the molded case circuit breaker's main contacts (see figure).

A toggle lever extension is supplied with the VL 1200 UL (NG frame) and VL1600 UL (PG frame) molded case circuit breakers. For the VL400 UL (JG frame) to VL800 UL (MG frame) molded case circuit breakers, this accessory must be ordered separately if required.

Front-operated rotary operating mechanisms

These operating mechanisms are designed for direct attachment to 3VL molded case circuit breakers according to UL and convert movement of the toggle lever from a linear to a rotary movement.

For a molded case circuit breaker with leading auxiliary switches, the undervoltage release can be connected to voltage in a leading fashion, as a result of which the molded case circuit breaker is ready for closing.

Door-coupling rotary operating mechanisms (complete operating mechanisms)

When the molded case circuit breakers are installed in control cabinets and distribution boards, door-coupling rotary operating mechanisms are available for doors and removable covers. These operating mechanisms are supplied as complete assembly kits, including an articulated-shaft mechanism.

With regard to switch positions and the "RESET" position, the same applies to rotary operating mechanisms as to toggle lever operating mechanisms. Indication is by the position of the operator lever (knob).

All 3VL molded case circuit breakers according to UL that feature these rotary operating mechanisms and corresponding terminal covers can be used as main disconnecting means.

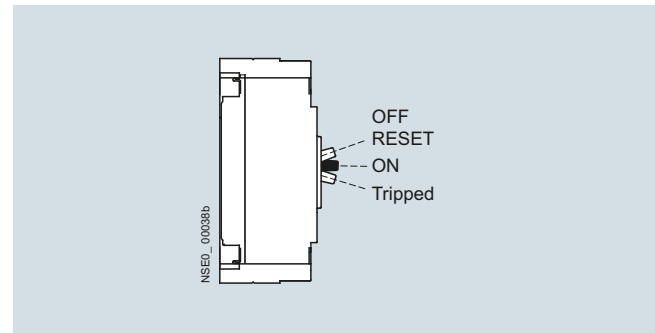

Toggle lever operating mechanism positions

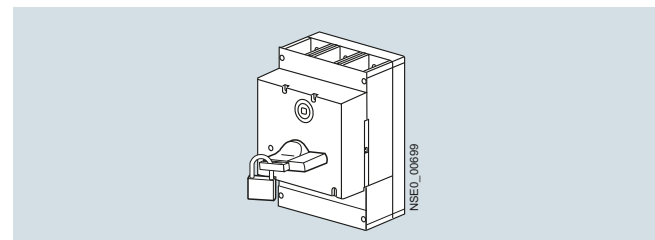

Rotary operating mechanism locked with padlock

Motorized operating mechanisms

VL150X UL (CG frame) to VL1600 UL (PG frame) molded case circuit breakers can be equipped with motorized operating mechanisms for operational remote closing and opening.

The motorized operating mechanisms for VL150X UL (CG frame) to VL800 UL (MG frame) molded case circuit breakers have a spring energy store (for synchronization) with a maximum ON period of $t_{\text{e}} \leq 80$ ms.

Motorized operating mechanisms without spring energy store for remotely controlled ON and OFF switching are available for the VL1200 UL (NG frame) and VL1600 UL (PG frame) molded case circuit breakers.

All motorized operating mechanisms are always supplied with a locking device for padlocks. Moreover, optional safety locks for motorized operating mechanisms with stored energy mechanism are also available.

The locking devices can be used for electrical and mechanical blocking of the operating mechanism. All remote operating mechanisms are equipped with a manual operating possibility for maintenance purposes.

Optionally, the motorized operating mechanisms for VL150X UL (CG frame) to VL800 UL (MG frame) and also the motorized operating mechanisms for VL1200 UL (NG frame) and VL1600 UL (PG frame) are each internally equipped with a floating signaling contact (normally open) for the following functions:

- Querying the AUTO/Manual selector switch for VL150X UL (CG frame) to VL800 UL (MG frame)
- Operating the mechanical OFF/0 button

Molded Case Circuit Breakers

3VL Molded Case Circuit Breakers up to 1600 A, according to UL 489

General data

Main connections, basic equipment and options

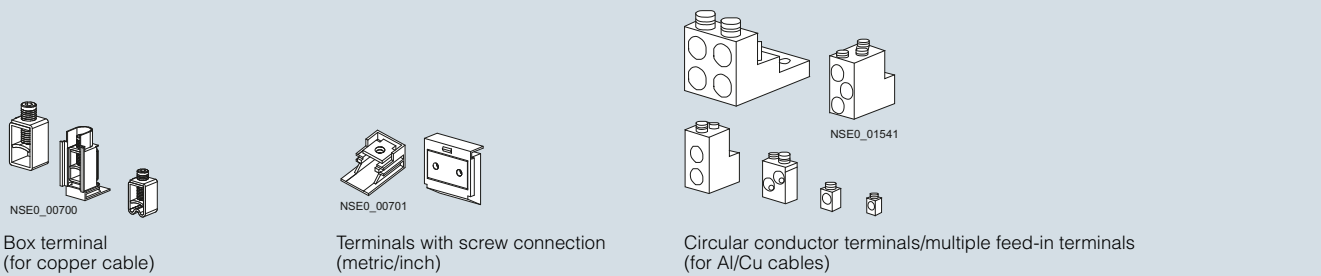

Main connections

Molded case circuit breaker	Connection overview and further options						
	Box terminals Cu only	Screw terminals for flat connection		Circular conductor terminal/multiple feed-in terminal Cu or Al	Rear terminals	Cable lug connection	Direct connection of bars possible (IEC-approved circuit breakers only)
		with metric thread	with inch thread				
VL150X UL (CG frame)	x	x	--	x	x	--	--
VL150 UL (DG frame)	x	x	x	x	x	x	--
VL250 UL (FG frame)	x	x	x	x	x	x	--
VL400 UL (JG frame)	x	x	--	x ^{1) 2)}	x	x	--
VL400X UL (LG frame)	--	x	x	x ^{1) 2)}	x	x	--
VL800 UL (MG frame)	--	x	x	x ¹⁾	x	x	--
VL1200 UL (NG frame)	--	x	x	x ¹⁾	x	x	--
VL1600 UL (PG frame)	--	x	x	x ¹⁾	x	--	--

x Available

-- Not available

¹⁾ Multiple feed-in terminals

²⁾ Circular conductor terminal also available.

Note

See operating instructions for conductor cross-sections.

Auxiliary releases and auxiliary switches

Undervoltage releases, leading auxiliary switches

If there is no voltage present, closing of the molded case circuit breaker is not possible. When no voltage is applied to the release, operating the circuit breaker leads to no-load switching.

Frequent no-load switching should be avoided to prevent shortening the molded case circuit breaker's useful life.

For a molded case circuit breaker with leading auxiliary switches, the undervoltage release can be connected to voltage in a leading fashion, as a result of which the molded case circuit breaker is ready for closing.

In the case of 3VL molded case circuit breakers according to UL, the leading auxiliary switch can be supplied together with the front-operated rotary operating mechanisms and complete operating mechanisms. For further information, see "Selection and ordering data" for accessories.

Shunt releases

Shunt releases are used to remotely trip the molded case circuit breaker.

The shunt release's coil is designed for short-time operation. Coil deactivation is installed internally.

When a molded case circuit breaker is open, it is not permitted to apply a continuous opening command to the shunt release to prevent closing. A center tap is available as standard to test the coil for continuity.

Note

Before ordering, use the graphic on the right to check whether the required combination of shunt releases, undervoltage releases and auxiliary/alarm switches is feasible.

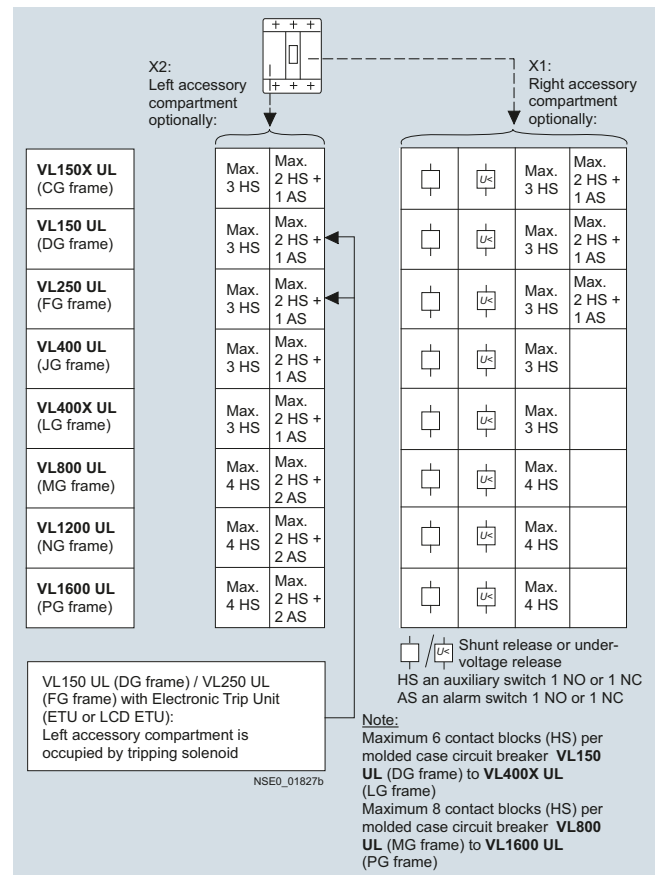

Equipment options for the insulated accessory compartments in the 3VL molded case circuit breakers according to UL

Auxiliary switches

Auxiliary switches (HS) are used for signaling and controlling. The contacts of the auxiliary switch open and close along with the main contacts.

Alarm switches

Alarm switches (AS) operate when the molded case circuit breaker has been tripped due to an overcurrent situation, e.g. an overload or short-circuit. However, they are also activated when the molded case circuit breaker has been tripped by a shunt release or an undervoltage release.

Installation of internal accessories

The insulated accessory compartments in the molded case circuit breakers for installation of internal accessories (auxiliary releases and auxiliary/alarm switches) are designated X1, X2 and X4.

Equipment of the molded case circuit breaker with internal accessories and the possibility of combination with auxiliary releases and auxiliary/alarm switches depend on the installation position and frame size of the molded case circuit breaker (see figure entitled "Equipment options for the insulated accessory compartments in the 3VL molded case circuit breakers according to UL").

PLC control

The auxiliary and alarm switches are suitable for PLC control. These switching elements are from the Siemens 3SB3 program.

Leading auxiliary switches

The leading auxiliary switches from OFF to ON or from ON to OFF are available as retrofit kits and for Max Flex operating mechanisms.

The following measurement methods can be used to detect neutral conductor and ground-fault currents:

Vectorial summation current formation (measurement method 1)

Ground-fault detection in balanced systems

The three phase currents are evaluated using vectorial summation current formation.

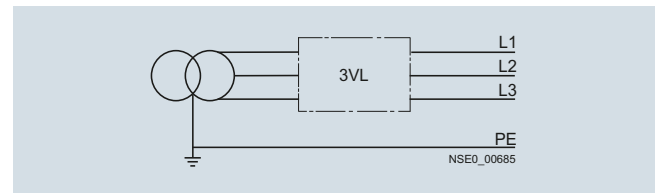

Ground-fault detection in unbalanced systems

The neutral conductor current is measured directly and, in the case of the 3-pole circuit breakers, is only evaluated for ground-fault protection.

The overcurrent release calculates the ground-fault current using the vectorial summation of the three phase currents and the neutral conductor current.

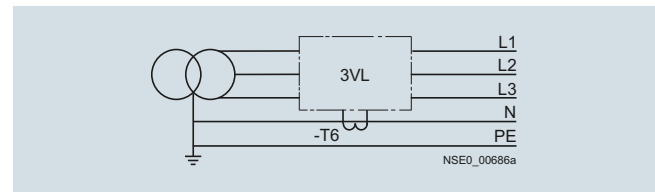

3-pole molded case circuit breaker, current transformer in neutral conductor

Direct detection of the ground-fault current via a current transformer at the grounded star point of the transformer (measurement method 2)

The current transformer is installed directly at the grounded neutral point of the transformer.

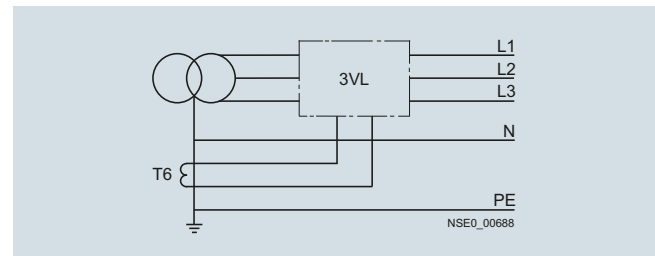

3-pole molded case circuit breaker, current transformer at the grounded star point of the transformer

Transformer protection

The 3VL molded case circuit breakers according to UL protect power distribution systems in the event of overload and short-circuit as from the low-voltage side of the infeed transformer. The resulting requirements for current and/or time-based discrimination are fulfilled reliably by 3VL molded case circuit breakers according to UL for line protection – equipped with thermal-magnetic (TM) or electronic trip units (ETU or LCD ETU).

Function

Current limiting¹⁾

3VL molded case circuit breakers according to UL are designed on the principle of magnetic repulsion of the contacts. The contacts open before the expected peak value of the short-circuit current is reached. The current-limiting effects of the 3VL molded case circuit breakers according to UL protect the system components effectively against thermal and dynamic effects of the short-circuit current in the event of an electrical fault.

Ground-fault protection

The ground-fault release "G" captures fault currents escaping to ground that can cause fires in the plant. Several molded case circuit breakers connected in series can be assigned graduated discrimination by means of the adjustable delay time.

¹⁾ Not current-limiting in terms of "Current limiting according to UL 489".

Molded Case Circuit Breakers

3VL Molded Case Circuit Breakers up to 1600 A, according to UL 489

General data

Thermal-magnetic releases (TM)

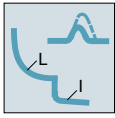

NSE0_00689

Application: line protection –
 TM, LI/LIN function

Overload protection, non-adjustable,
 short-circuit protection, non-adjustable,
 see "Selection and ordering data" for
 VL150X UL (CG frame),
 integrated releases in the circuit breaker enclosure;
 KM version.



I201_19069

Application: line protection –
 TM/model 525, LI/LIN function

Overload protection, non-adjustable,
 short-circuit protection, adjustable
 $I_i = 5$ to $10 \times I_n^{(1)}$, for VL150 UL (DG frame)
 to VL1600 UL (PG frame);

KN version

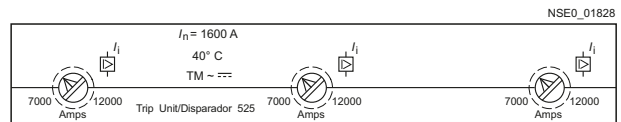

NSE0_01828



NSE0_00707

Application: starter protection –
 M, I function

Short-circuit protection, adjustable
 $I_i = 3$ to $16 \times I_n^{(1)}$, for VL150 UL (DG frame) to
 VL1200 UL (NG frame);

KJ, KK, KL versions.

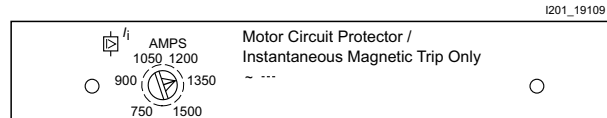

I201_19109



NSE0_00708

Application: switch disconnectors in molded case
 circuit breaker design – M, I function
 (for intrinsic protection)

Short-circuit protection, non-adjustable

KE version

¹⁾ Size-dependent, see "Selection and ordering data".

Electronic Trip Units (ETUs)

For types
 VL150 UL
 (DG frame)
 to VL1600
 UL (PG
 frame)

General information:

- No auxiliary voltage required for release system
- All ETUs have a thermal image
- A flashing green LED indicates correct operation of the microprocessor

- Overload status ($I > 1.05 \times I_r$) is indicated by a permanently lit yellow LED (alarm)
- Integral self-test function
- Socket for battery power supply
- Communication link to PROFIBUS DP and Modbus RTU possible



Application: line protection – model 555, LI function

Overload protection $I_r = 0.28$ to $1 \times I_n^{(1)}$,
 time-lag class $t_r = 2.5$ to 30

Short-circuit protection (instantaneous)
 $I_i = 1.25$ to $11 \times I_n^{(1)}$,

PB version

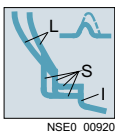
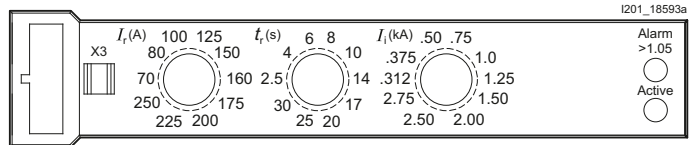

Application: line and generator protection – model 555, LSI function

Overload protection $I_r = 0.4$ to $1 \times I_n^{(1)}$,

Short-circuit protection (short-time delay)
 $I_{sd} = 1.5$ to $10 \times I_R^{(1)}$, $t_{sd} = 0$ to 0.5 s,

I^2t on/off selectable

Short-circuit protection (instantaneous)
 $I_i = 1.25$ to $11 \times I_n$ (fixed)¹⁾

PE version

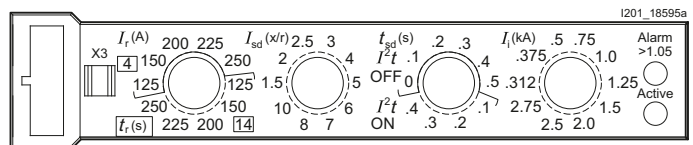

Application: line protection – model 555, LIG function

Overload protection $I_r = 0.28$ to $1 \times I_n^{(1)}$,
 time-lag class $t_r = 2.5$ to 30

Short-circuit protection (instantaneous)
 $I_i = 1.25$ to $11 \times I_n^{(1)}$

Ground-fault protection:
 Measurement method No. 1:
 (G_R) vectorial summation current formation of the currents in the three phases and the neutral conductor (4-wire systems); $I_g = 0.4$ to $1 \times I_n^{(1)}$

PD version

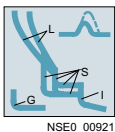
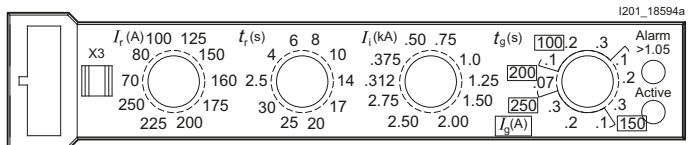

Application: line and generator protection – model 555, LSIG function

Overload protection $I_r = 0.4$ to $1 \times I_n^{(1)}$,

Short-circuit protection (short-time delay)
 $I_{sd} = 1.5$ to $10 \times I_R^{(1)}$, $t_{sd} = 0$ to 0.5 s,

I^2t on/off selectable

Short-circuit protection (instantaneous)
 $I_i = 1.25$ to $11 \times I_n^{(1)}$

Ground-fault protection:
 Measurement method No. 1:
 (G_R) vectorial summation current formation of the currents in the three phases and the neutral conductor (4-wire systems); $I_g = 0.4$ to $1 \times I_n^{(1)}$

PH version

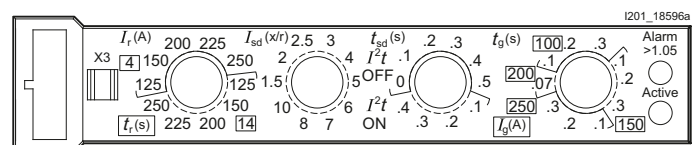

¹⁾ Size-dependent, see "Selection and ordering data".

Molded Case Circuit Breakers

3VL Molded Case Circuit Breakers up to 1600 A, according to UL 489

General data

Electronic Trip Units with LCD (LCD ETU)

General information:

- No auxiliary voltage required for release system
- Current display
- An illuminated green LCD display indicates correct operation of the microprocessor
- Overload status ($I > 105\% I_r$) is indicated by "Overload" on the LCD display

- Direct, user-friendly, menu-driven setting of the absolute values of the protection parameters in the ampere values via keys
- Integral self-test function
- Socket for battery power supply
- Communication link to PROFIBUS DP and Modbus RTU possible

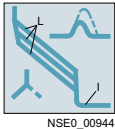

NSE0_00944

Application: line protection – model 586, LSI function

Overload protection $I_r = 0.4$ to $1 \times I_n$,
time-lag class $t_r = 2.5$ to 30

Thermal image selectable on/off

Short-circuit protection (short-time delay)

$I_{sd} = 1.25$ to $10 \times I_R^{(1)}$, $t_{sd} = 0$ to 0.5 s,

I^2t on/off selectable

Short-circuit protection (instantaneous)

$I_i = 1.25$ to $11 \times I_n^{(1)}$

VH version

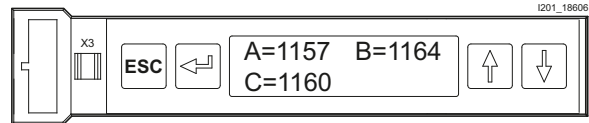

i201_18606

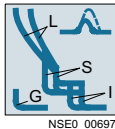

NSE0_00697

Application: line protection – model 586, LSI G function

Overload protection $I_r = 0.4$ to $1 \times I_n$,
time-lag class $t_r = 2.5$ to 30

Thermal image selectable on/off

Short-circuit protection (short-time delay)

$I_{sd} = 1.25$ to $10 \times I_R^{(1)}$, $t_{sd} = 0$ to 0.5 s,

I^2t on/off selectable

Short-circuit protection (instantaneous)

$I_i = 1.25$ to $11 \times I_n^{(1)}$

Ground-fault protection: Measurement method No. 1:

(G_R) vectorial summation current formation of the currents in the three phases and the neutral conductor (4-wire systems);

$I_g = 0.4$ to $1 \times I_n^{(1)}$.

Measurement method No. 2:

(G_{GND}) direct measurement of the ground-fault current using a current transformer, $I_g = 0.4$ to $1 \times I_n$,

$t_g = 0.1$ to 0.5 s.

VM version

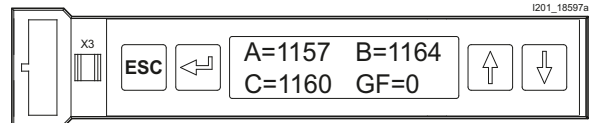

i201_18697a

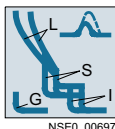

NSE0_00697

Application: line protection – model 586, LSI G (alarm) function

Overload protection $I_r = 0.4$ to $1 \times I_n$,
time-lag class $t_r = 2.5$ to 30

Thermal image selectable on/off

Short-circuit protection (short-time delay)

$I_{sd} = 1.25$ to $10 \times I_R^{(1)}$, $t_{sd} = 0$ to 0.5 s,

I^2t on/off selectable

Short-circuit protection (instantaneous)

$I_i = 1.25$ to $11 \times I_n^{(1)}$

Ground-fault protection:

Measurement method No. 1:

(G_R) vectorial summation current formation of the currents in the three phases and the neutral conductor (4-wire systems);

$I_g = 0.4$ to $1 \times I_n^{(1)}$.

Measurement method No. 2:

(G_{GND}) direct measurement of the ground-fault current using a current transformer, $I_g = 0.4$ to $1 \times I_n$,

$t_g = 0.1$ to 0.5 s.

If a ground fault is detected, the LCD ETU only issues an alarm, without tripping the circuit breaker. This alarm is displayed direct on the display and/or is communicated to higher-level systems via PROFIBUS DP/Modbus RTU.

VJ version

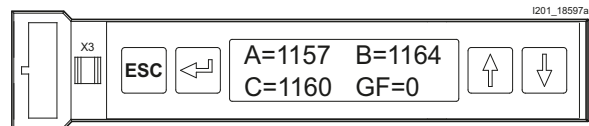

i201_18697a

¹⁾ Size-dependent, see "Selection and ordering data".

Configuration

Communication

All 3VL molded case circuit breakers according to UL 489 with electronic trip unit (ETU) are communication-capable. To this end, the molded case circuit breaker's ETU is connected to a COM20 or COM21 communication module by means of a cable. The COM20 module (Release 2) supports the PROFIBUS DP protocol, while the COM21 module (Release 2) enables data transfer via Modbus RTU.

A communication kit – COMKIT 3 to 8 – is needed to connect the 3VL molded case circuit breaker (see page 2/271).

The COMKITS consists of a connecting cable including a protective cover and also one alarm and auxiliary switch each for installation in the molded case circuit breaker.¹⁾ These are also connected to the electronic trip unit and signal the ON/OFF/TRIPPED circuit breaker status to the electronic trip unit.

The communication modules enable activation and deactivation of an optional motorized operating mechanism.

Data transmission through COM20/COM21 (Release 2)

Data transferred	
Commands	
Closing or opening	✓
Deleting alarm and tripping operation buffer and also maintenance information	✓
Operating states²⁾	
ON or OFF status trip position	✓
Event messages	
Tripped messages with tripping current	✓
Alarms (e.g. overload, phase unbalance current, etc.)	✓
Threshold violation (e.g. phase currents)	✓
Measured values	
Phase currents and neutral conductor current	✓
Parameter values	
Reading and writing	✓
Maintenance information	
(e.g. number of trips, number of switching operations)	✓
Data for device identification	✓
Clock synchronization	✓

✓ Available

Function	COM20/21 (Release 2) module with overcurrent release version	
	ETU	LCD ETU
Functions of communication components		
Transfer of the operating state (ON, OFF, tripped, warnings, tripped causes, event log, etc.) to the PROFIBUS	✓	✓
Display of measured values (current only) and parameters in the release, modifying parameters via the display	--	✓ ³⁾
Transferring the maximum value of the actual current in %	✓	✓
Transferring the individual current phase currents	✓	✓
Transferring PROFIBUS identification data	✓	✓
Reading protection parameters via PROFIBUS/Modbus	✓	✓
Reading and setting protection parameters via PROFIBUS/Modbus	--	✓

✓ Function available

Function can optionally be adopted by several trip units.

-- Function not available

¹⁾ Only an alarm switch is included with the COMKITS 3 and 6 because the auxiliary switch in the case of DG and FG frame sizes of the 3VL molded case circuit breakers is already included in the magnetic release (Maglatch).

²⁾ Only in the case of built-in auxiliary switches connected to COM20/21 (Release 2)

³⁾ COM20/21 not required

Molded Case Circuit Breakers

3VL Molded Case Circuit Breakers up to 1600 A, according to UL 489

General data

Switching direct current

The VL150X UL (CG frame) to VL1600 UL (PG frame) molded case circuit breakers for line protection with thermal-magnetic releases, for starter combinations, and for non-automatic air circuit breaker versions are also suitable for switching and protecting direct current.

The maximum permitted DC voltage for each conducting path needs to be taken into account for DC switching applications, however.

Series connection of 2 to 3 conducting paths is required for voltages in excess of 250 V in the case of VL150 UL (DG frame) to VL1600 UL (PG frame).

The following circuits are recommended since the current must flow through all conducting paths in order to conform to the thermal tripping characteristic curves.

The threshold values of the instantaneous short-circuit release ("I" release) increase by 30 to 40 %.

Recommended circuit/maximum permitted DC voltage U_e		Remarks
Circuit A	Circuit B	
For 3-pole molded case circuit breakers		
250 V DC NSE0_01861a	500 V DC rated / 600 V DC max. for use in ungrounded UPS DC applications (according to UL 489, Supplement SC)	2-pole switching (ungrounded system)
NSE0_00741a		

Technical specifications

Type	VL150X UL CG frame	VL150 UL DG frame	VL250 UL FG frame	VL400 UL JG frame	VL400X UL LG frame	VL800 UL MG frame	VL1200 UL NG frame	VL1600 UL PG frame	
Max. rated current I_n	A 150	150	250	400	600	800	1200	1600	
Rated insulation voltage U_i, only in accordance with IEC 60947-2									
Main conducting paths	AC	V 800							
Auxiliary circuits	AC	V 690							
Rated operational voltage U_e									
NEMA 50/60 Hz	AC	V 600							
	DC ¹⁾	V 250	2)						
IEC 50/60 Hz	AC	V 690							
Utilization category	A								
Permissible ambient temperature									
Operation: 0 °C ... +70 °C for devices with TM release (cf. IEC system manual)	°C	-25 ... +70							
Storage	°C	-40 ... +80							
Permissible load at different ambient temperatures									
Directly next to the molded case circuit breaker, referred to the molded case circuit breaker's rated current									
• Molded case circuit breaker for line protection	TM/ETU	up to 40 °C	% 100	100/100				100/100	100/100
	TM/ETU	at 50 °C	% 93	93/100				94/100	92/100
	TM/ETU	at 60 °C	% 86	86/95				88/95	83/95
	TM/ETU	at 70 °C	% 79	79/80				82/80	75/80
• Molded case circuit breaker for starter combinations and non-automatic air circuit breakers		up to 40 °C	% 100						
		at 50 °C	% 100						
		at 60 °C	% 93						
		at 70 °C	% 86						
Weight data of 3-pole molded case circuit breakers									
Basic circuit breaker									
• With thermal-magnetic release	kg	2.5	2.2	2.3	5.7	9.0	14.0	21.8	32.8
• With electronic trip unit	kg	--	2.4	2.5	5.9	9.3	16.0	25.0	31.3
Rated short-circuit breaking capacity	Rated short-circuit breaking capacity: see under "Overview" in table.								

¹⁾ DC rated data applies to thermal-magnetic releases only.

²⁾ 500 V DC rated / 600 V DC max. for use in ungrounded UPS DC applications (according to UL 489, Supplement SC)

Molded Case Circuit Breakers

3VL Molded Case Circuit Breakers up to 1600 A, according to UL 489

General data

2

Type		VL150X UL CG frame	VL150 UL DG frame	VL250 UL FG frame	VL400 UL JG frame	VL400X UL LG frame	VL800 UL MG frame	VL1200 UL NG frame	VL1600 UL PG frame
Endurance	Switching cycles	20000				10000		3000	
Electrical endurance	Switching cycles	10000				5000	3000	1500	
Max. switching frequency	1/h	120				60		30	
Connection types		See "Main connections, basic equipment and options"							
Connection cross-sections for stranded cables									
Box terminal (Cu)	AWG/kcmil mm ²	1 x (14 ... 1/0) 1 x (2.5 ... 50)	1 x (8 ... 1/0) 1 x (10 ... 50)	1 x (3 ... 250) 1 x (35 ... 120)	1 x (1/0 ... 600) 1 x (70 ... 300)	--	--	--	--
Circular conductor terminal (Cu/Al)	AWG/kcmil mm ²	1 x (6 ... 3/0)		1 x (4 ... 350)	1 x Cu: 3/0 ... 600 Al: 250 ... 750	--	--	--	--
Circular conductor terminal with terminal cover (Cu/Al)	AWG/kcmil mm ²	--	1 x (6 ... 300) 1 x (16 ... 150)	--	1 x Cu: 95 ... 300 Al: 150 ... 300	--	--	--	--
Multiple feed-in terminal (Cu/Al)	AWG/kcmil	--	--	--	2 x (3/0 ... 250)	2 x (2 ... 600)	2 x (500 ... 750)	--	--
	mm ²	--	--	--	2 x (95 ... 120)	2 x (35 ... 300)	2 x 300	--	--
	AWG/kcmil	--	--	--	--	--	3 x (1/0 ... 500)	3 x (500 ... 750)	--
	mm ²	--	--	--	--	--	3 x (70 ... 240)	3 x 300	--
	AWG/kcmil	--	--	--	--	--	--	4 x (1/0 ... 500)	--
	mm ²	--	--	--	--	--	--	4 x (70 ... 240)	--
	AWG/kcmil	--	--	--	--	--	--	--	4 x (600 ... 750)
	mm ²	--	--	--	--	--	--	--	4 x 300
Multiple feed-in terminal with terminal cover	AWG/kcmil mm ²	--	--	--	2 x (2 ... 600) 2 x (35 ... 300)	--	--	--	--
Direct connection of busbars (Cu/Al, for IEC only)	mm	17 x 7	22 x 7	24 x 7	32 x 10	32 x 10	2 x 40 x 10	2 x 50 x 10	3 x 60 x 10
Screw for connection with screw terminal, metric	M	M 6	--	M 8	--	M10	M 8	--	--
	inch	--	10-32 UNF	5/16	--	3/8	5/16	--	--
Power losses per molded case circuit breaker at max. rated current									
Line protection	TM	W 17 ... 36	15 ... 48	32 ... 80	60 ... 175	85 ... 230	194 ... 269	150 ... 204	204 ... 329
Line protection	ETU or LCD ETU	W --	6 ... 40	11 ... 60	38 ... 90	71 ... 160	140 ... 250	93 ... 210	146 ... 260
For starter combinations or non-automatic air circuit breakers	W	36	40	60	90	160	250	210	260
Permissible mounting position¹⁾									

¹⁾ For VL800 UL (MG frame) to VL1600 UL (PG frame) molded case circuit breakers with withdrawable unit frame in lateral installation position. Adapter set on request.

²⁾ Permissible current load factor 0.9; with internal accessories only.

Molded Case Circuit Breakers

3VL Molded Case Circuit Breakers up to 1600 A, according to UL 489

General data

Type		VL150X UL CG frame	VL150 UL DG frame	VL250 UL FG frame	VL400 UL JG frame	VL400X UL LG frame	VL800 UL MG frame	VL1200 UL NG frame	VL1600 UL PG frame	
Auxiliary switches and alarm switches										
Conventional free-air thermal current I_{th}	A	10								
Rated making capacity	A	10								
AC										
Rated operational voltage	V	24	48	110	230	400	600	--		
Rated operating current	AC-12 A	10								
	AC-15 A	6			3	1	--			
DC										
Rated operational voltage	V	24	48	110	230	--				
Rated operating current	DC-12 A	10	5	2.5	1	--				
	DC-13 A	3	1.5	0.7	0.3	--				
Back-up fuse/miniature circuit breaker	A	10 TDz / 10								
Leading auxiliary switch in rotary mechanism										
Rated thermal current I_{th}	A	2								
Rated making capacity	A	2 (ind. 0.5)								
Rated operational voltage	V AC	230								
Rated operating current	A	2								
Rated breaking capacity, inductive, p.f. = 0.7	A	0.5								
Rated breaking capacity	A	2								
Quick-response short-circuit fuse	A	2								
Position signaling switches										
Rated thermal current I_{th}	A	16	--							
Rated making capacity	A	16	10	--						
Rated operational voltage	V AC	250	400	--						
Rated operating current	A	16	10	--						
Rated breaking capacity, inductive, p.f. = 0.7	A	4	--							
Rated breaking capacity	A	16	10	--						
Quick-response short-circuit fuse	A	16	10	--						
Release										
		Family 1: VL150X UL (CG frame) to VL400X UL (LG frame)					Family 2: VL800 UL (MG frame) to VL1600 UL (PG frame)			
Undervoltage releases										
Response voltage:										
• Release (circuit breaker trips)	V	0.35 ... 0.70 × U_s					0.35 ... 0.70 × U_s			
• Pick-up (circuit breaker can be switched on)	V	0.85 ... 1.1 × U_s					0.85 ... 1.1 × U_s			
Power consumption (continuous operation) at:										
• 24 V AC 50/60 Hz ¹⁾	VA	1.4					--			
• 110 ... 127 V AC 50/60 Hz	VA	1.0					1.8			
• 220 ... 250 V AC 50/60 Hz	VA	1.0					1.8			
• 208 V AC 50/60 Hz	VA	1.0					1.8			
• 277 V AC 50/60 Hz	VA	1.0					1.8			
• 380 ... 415 V AC 50/60 Hz	VA	1.0					1.8			
• 440 ... 480 V AC 50/60 Hz	VA	1.0					1.8			
• 500 ... 525 V AC 50/60 Hz	VA	1.0					--			
• 12 V DC	W	0.8					1.5			
• 24 V DC	W	0.8					1.5			
• 48 V DC	W	0.8					1.5			
• 60 V DC	W	0.8					1.5			
• 110 ... 127 V DC	W	0.8					1.5			
• 220 ... 250 V DC	W	0.8					1.5			
Max. opening time	ms	50					50			
Shunt releases										
Response voltage:										
Pick-up (switch tripped)	V	U_s					U_s			
Power consumption (short-time) at:										
• 24 V AC 50/60 Hz	VA	310					330			
• 48 ... 60 V AC 50/60 Hz	VA	335 ... 465					380 ... 460			
• 110 ... 127 V AC 50/60 Hz	VA	470 ... 630					330 ... 430			
• 208 ... 277 V AC 50/60 Hz	VA	585 ... 1000					520 ... 800			
• 380 ... 600 V AC 50/60 Hz	VA	180 ... 500					228 ... 750			
• 24 V DC	W	360					385			
• 48 ... 60 V DC	W	380 ... 590					480 ... 720			
• 110 ... 127 V DC	W	506 ... 680					362 ... 424			
• 220 ... 250 V DC	W	470 ... 580					418 ... 476			
Max. opening time	ms	50					50			
Max. in-service period	s	interrupts automatically, less than 10 ms					interrupts automatically, less than 10 ms			

1) On request.

Type	VL150X UL		VL150 UL	VL250 UL	VL400 UL	VL400X UL	VL800 UL	VL1200 UL	VL1600 UL		
	CG frame	DG frame	FG frame	JG frame	LG frame	MG frame	NG frame	PG frame			
Motorized operating mechanism	--							x			
Motorized operating mechanism with spring energy store (synchronizable)	x								--		
Motorized operating mechanism											
Power consumption	VA/W	--							< 250		
Rated control supply voltage U_s	50/60Hz V AC	--						42 ... 48/60	110 ... 127/220 ... 250		
	V DC	--						24 / 42 ... 48/60	110 ... 127/220 ... 250		
Fusible link (operational class gG, slow-blow characteristic)	A	--						4	2		
Miniature circuit breakers	A	--						4	2		
Primary operating range	V	--						0.85 ... 1.1 x U_s			
Min. command duration U_s	ms	--						50			
Max. command duration, connection-dependent ¹⁾		Jog/pushbutton or continuous command			--			Jog/pushbutton or continuous command			
Total make-time	s	--						< 5			
Break-time	s	--						< 5			
Interval between the commands OFF and ON	s	--						> 5			
Interval between the commands ON and OFF	s	--						> 5			
Max. permissible switching frequency	1/h	--						30			
Motorized operating mechanism with spring energy store (synchronizable)											
Power consumption	VA/W	< 100			< 200		< 250		--		
Rated control supply voltage U_s	50/60Hz V AC	42 ... 48 / 60			110 ... 127 / 220 ... 250			--			
	V DC	24 / 42 ... 48 / 60			110 ... 127 / 220 ... 250			--			
Fusible link (operational class gG, slow-blow characteristic)	A	4			2				--		
Miniature circuit breakers	A	4			2				--		
Primary operating range	V	0.85 ... 1.1 x U_s									
Min. command duration U_s	ms	50									
Max. command duration, connection-dependent ¹⁾		Jog/pushbutton or continuous command									
Total make-time	ms	< 100									
Break-time	s	< 5									
Interval between the commands OFF and ON	s	> 5									
Interval between the commands ON and OFF	s	> 1									
Max. permissible switching frequency	1/h	120					60		--		

x Available

-- Not available

¹⁾ Changerover contact also permissible, but note the interval times between ON and OFF.

Molded Case Circuit Breakers

3VL Molded Case Circuit Breakers up to 1600 A, according to UL 489

General data

Space requirement above arc chutes, safety clearance (applicable to IEC application)

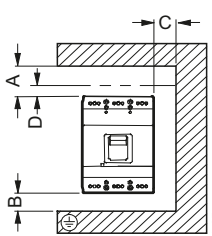

Arcing spaces

Minimum clearances from adjacent grounded parts and non-insulated live parts.

Inside the arcing space, bare conductors and bars must be insulated with phase barriers.

For bare conductors and bars outside the arcing space, the specific mounting instructions for the different frame sizes must be observed.

For mounting instructions, see www.siemens.com/lowvoltage/product-support

Space requirement above arcing spaces according to IEC 60947-2

Molded case circuit breaker	Breaking capacity	Minimum enclosure volume	A			B	C	D
			≤ 415 V	>415 ... 690 V	>415 ... 690 V			
Type		m ³	without/with terminal cover	without terminal cover	with terminal cover	≤ 690 V	≤ 690 V	≤ 690 V
VL150X UL (CG frame)	Standard High Very high	0.011	35	70	35	25	25	35
VL150 UL (DG frame)	Standard High Very high	0.011	50	100	50	25	25	35
VL250 UL (FG frame)	Standard High Very high	0.015	50	100	50	25	25	35
VL400 UL (JG frame)	Standard High Very high	0.036	50	100	50	25	25	35
VL400X UL (LG frame)	Standard High Very high	0.18	50	100	50	25	25	35
VL800 UL (MG frame)	Standard High Very high	0.22	50	100	50	25	25	35
VL1200 UL (NG frame)	Standard High Very high	0.22	70	100	70	30	30	50
VL1600 UL (PG frame)	Standard High Very high	0.264	100	100	100	100	30	100

Definition of permissible safety clearances

Clearance between

- A: molded case circuit breaker and busbars (uninsulated and grounded metal); terminal cover required above 600 V AC, 500 V DC
- B: molded case circuit breaker terminal and lower panel
- C: side of the molded case circuit breaker and side panels (uninsulated and grounded metal)
- D: molded case circuit breaker and non-conductive parts with at least 3 mm thick insulation (insulator, insulated bar, painted plate)